



INTERPOL

INTERPOL Implementation for Data Format for the Interchange of Fingerprint, Facial and Biometric Information

**XML format, version 06.00.01
Based on ANSI/NIST ITL 2011 Upd 2015**

INTERPOL AFIS Expert Working Group

31/08/2020

This new INTERPOL Implementation of the NIST XML Standard is now available with its entire package on our GitHub platform for consultation and download by the public. It is accessible by all using this URL:

<https://github.com/INTERPOL-Innovation-Centre/ANSI-NIST-XML-ITL-Implementation>

Feedback, questions, or issues can and should be submitted via the [Issue](#) Page to be reviewed and addressed by the dedicated INTERPOL Working Group. All other requests can be addressed by email to:

NIST.STANDARD@INTERPOL.INT

Contents

1.	The History and the Spirit	21
2.	How to Apply the INTERPOL Implementation	23
3.	Content of the Information Exchange Package Description (IEPD)	24
4.	Data Conventions	25
4.1.	XML Namespaces	25
4.1.1.	Forewords	25
4.1.2.	nc	25
4.1.3.	biom	25
4.1.4.	itl	25
4.1.5.	iso3166	26
4.1.6.	int-i	26
4.2.	Basic Data Types	26
4.2.1.	Date and Time Types	26
4.2.2.	ISO 3166-1 Alpha-3 Country Codes Type	27
4.2.3.	int-i ISO 3166-1 Alpha-3 Country Codes Type	27
4.2.4.	int-i National Identifier Type	27
5.	File Description	29
5.1.	File Content	29
5.2.	Implementation Domains	30
6.	Record Description	31
6.1.	Logical Record Types	31
6.2.	Transaction Information Record (aka Type 1)	31
6.3.	User-defined Descriptive Text Record (aka Type 2)	31
6.4.	Minutiae Data Record (aka Type 9)	32
6.5.	Face, Other Body Part, or SMT Image Record (aka Type 10)	32
6.6.	Variable-Resolution Latent Image Record (aka Type 13)	32
6.7.	Variable-Resolution Fingerprint Image Record (aka Type 14)	32
6.8.	Variable-Resolution Palm Print Image Record (aka Type 15)	33
6.9.	Source Representation Record (aka Type 20)	34
7.	Implementation Guidelines	35
7.1.	Validating XML against INT-I Schemas	35
7.2.	Main Differences with the Previous INTERPOL Implementations	35
7.3.	Limitations	36
7.4.	How to read the field description pages?	37
7.5.	INTERPOL AFIS Gateway	40
8.	Transaction Information Record (aka Type 1)	42
8.1.	Package Information Record (XML)	43

8.2.	XML Record Category Code - XRCC	45
8.3.	Transaction (XML)	46
8.4.	Major Version - VER	48
8.5.	Minor Version - VER	49
8.6.	Transaction Content (XML) - CNT	50
8.7.	First Record Category Code - FRC	51
8.8.	Content Record Count - CRC	52
8.9.	Content Record Summary (XML)	53
8.10.	Record Category Code (XML) - REC	54
8.11.	Information Designation Character (XML) - IDC	55
8.12.	Type of Transaction - TOT	56
8.13.	Date (XML) - DAT	57
8.14.	Priority - PRY	59
8.15.	Transaction Destination Organization (XML)	60
8.16.	Destination Agency Identifier - DAI	61
8.17.	Transaction Originating Organization (XML)	62
8.18.	Originating Agency Identifier - ORI	63
8.19.	Transaction Control Number - TCN	64
8.20.	Transaction Control Reference Number - TCR	66
8.21.	Transaction Image Resolution Details (XML)	67
8.22.	Native Scanning Resolution (XML) - NSR	68
8.23.	Nominal Resolution (XML) - NTR	69
8.24.	Domain Name - DOM	70
8.25.	Domain Name - DNM	71
8.26.	Domain Version Number - DVN	72
8.27.	Greenwich Mean Time (XML) - GMT	73
8.28.	Character Encoding - DCS	74
8.29.	Character Encoding Set Index - CSI	76
8.30.	Character Encoding Set Name - CSN	77
8.31.	Character Encoding Set Version - CSV	78
8.32.	Application Profile Specifications - APS	79
8.33.	Application Profile Organization - APO	80
8.34.	Application Profile Name - APN	81
8.35.	Application Profile Version Number - APV	82
8.36.	Destination Agency Name - DAN	83
8.37.	Originating Agency Name - OAN	84
8.38.	Destination Agency Country Code - DAC	85
8.39.	Originating Agency Country Code - OAC	86
8.40.	Geographical Name Set - GNS	87
8.41.	Field Mandatoriness in Transaction Information Record	88
8.42.	Type of Record Mandatoriness Depending on the TOT Value	89
9.	User-defined Descriptive Text Record (aka Type 2)	90
9.1.	Package Descriptive Text Record (XML)	91
9.2.	XML Record Category Code - XRCC	92
9.3.	Information Designation Character - IDC	93
9.4.	User-Defined Fields - UDF	94
9.5.	Domain-Defined Fields	95
9.6.	Record Activity Fields	97
9.7.	Record Subject Fields	98
9.8.	Record Offence Fields	100
9.9.	Record Civil Fields	101

9.10.	Record Metadata Fields	102
9.11.	Transaction Response Data Fields	104
9.12.	Transaction Metadata Fields	106
9.13.	Custom Defined Fields	107
9.14.	Date of Record - DAR	108
9.15.	Date of Last Update - DLU	109
9.16.	Case Reference (XML) - CNO	110
9.17.	Case Reference Country - CN1	111
9.18.	Case Reference Identifier - CN2	112
9.19.	Evidence Identifier - SQN	113
9.20.	Latent Identifier - MID	114
9.21.	Criminal Reference Number (XML) - CRN	115
9.22.	Country Code of the Criminal Reference Number - CR1	116
9.23.	Criminal Reference Number Value - CR2	117
9.24.	Business Reference Number (XML) - ORN	118
9.25.	Country Code of the Business Reference Number - OR1	120
9.26.	Business Reference Number Value - OR2	121
9.27.	Miscellaneous Identification Number 1 (XML) - MN1	122
9.28.	Miscellaneous Identification Number 1 (XML) - Type - MN1T	123
9.29.	Miscellaneous Identification Number 1 (XML) - Value - MN1V	124
9.30.	Miscellaneous Identification Number 2 (XML) - MN2	125
9.31.	Miscellaneous Identification Number 2 (XML) - Type - MN2T	126
9.32.	Miscellaneous Identification Number 2 (XML) - Value - MN2V	127
9.33.	Miscellaneous Identification Number 3 (XML) - MN3	128
9.34.	Miscellaneous Identification Number 3 (XML) - Type - MN3T	129
9.35.	Miscellaneous Identification Number 3 (XML) - Value - MN3V	130
9.36.	Miscellaneous Identification Number 4 (XML) - MN4	131
9.37.	Miscellaneous Identification Number 4 (XML) - MN4T	132
9.38.	Miscellaneous Identification Number 4 (XML) - MN4V	133
9.39.	Miscellaneous Identification Number 5 (XML) - MN5	134
9.40.	Miscellaneous Identification Number 5 (XML) - MN5T	135
9.41.	Miscellaneous Identification Number 5 (XML) - MN5V	136
9.42.	Date (and Time) Fingerprinted - DPR	137
9.43.	Offence Description Code - RFP	138
9.44.	Place Of Arrest - POA	139
9.45.	Place of Arrest (XML) - Free-text-form address - POA	140
9.46.	Place of Arrest (XML) - Structured-form address - POA	141
9.47.	Place of Arrest (XML) - Street number - PA1	143
9.48.	Place of Arrest (XML) - Street name - PA2	144
9.49.	Place of Arrest (XML) - City name - PA3	145
9.50.	Place of Arrest (XML) - County name - PA4	146
9.51.	Place of Arrest (XML) - State name - PA5	147
9.52.	Place of Arrest (XML) - Country code - PA6	148
9.53.	Place of Arrest (XML) - Postal code - PA7	149
9.54.	Capture Organization Information (XML) - OBU	150
9.55.	Capture Organization Information (XML) - Organization Identification - OB1	151
9.56.	Capture Organization Information (XML) - Organization Name - OB2	152
9.57.	Capture Organization Information (XML) - Free-text-form address - OB3	153
9.58.	Capture Organization Information (XML) - Structured-form address - OB4	154
9.59.	Capture Organization Information (XML) - Street number - OB5	155
9.60.	Capture Organization Information (XML) - Street name - OB6	156
9.61.	Capture Organization Information (XML) - City name - OB7	157

9.62.	Capture Organization Information (XML) – County name - OB8	158
9.63.	Capture Organization Information (XML) – State name - OB9	159
9.64.	Capture Organization Information (XML) – Country code - OB10	160
9.65.	Capture Organization Information (XML) – Postal code - OB11	161
9.66.	Name - NAM	162
9.67.	Person Prefix Name - NM1	164
9.68.	Person Given Name - NM2	165
9.69.	Person Middle Name - NM3	166
9.70.	Person Surname - NM4	167
9.71.	Person Suffix Name - NM5	168
9.72.	Person Maiden Name - NM6	169
9.73.	Person Extended Name - NM7	170
9.74.	Aliases - AKA	171
9.75.	Date of Birth (XML) - DOB	173
9.76.	Date of Birth Range (XML) - DBR	174
9.77.	Date of Birth Range (XML) - Min Date - SDA	175
9.78.	Date of Birth Range (XML) - Max Date - EDA	176
9.79.	Place of Birth (XML) - POB	177
9.80.	Place of Birth (XML) – Free text form - POB	179
9.81.	Place of Birth (XML) – Structured address form - POB	180
9.82.	Place of Birth (XML) – Street number - PB1	182
9.83.	Place of Birth (XML) – Street name - PB2	183
9.84.	Place of Birth (XML) – City name - PB3	184
9.85.	Place of Birth (XML) – County name - PB4	185
9.86.	Place of Birth (XML) – State name - PB5	186
9.87.	Place of Birth (XML) – Country code - PB6	187
9.88.	Place of Birth (XML) – Postal code - PB7	188
9.89.	Nationality - NAT	189
9.90.	Sex - SEX	190
9.91.	Offence Description Text - OTY	191
9.92.	Date (and Time) of Offence (XML) - DOO	192
9.93.	Date of Offence Range (XML) - DOR	193
9.94.	Date (and Time) of Offence Range (XML) - Min Date - SDA	194
9.95.	Date (and Time) of Offence Range (XML) - Max Date - EDA	195
9.96.	Additional Contact Information - INF	196
9.97.	Telephone number for the additional contact information - IN1	197
9.98.	Organization name for the additional contact information - IN2	198
9.99.	Person full name for the additional contact information - IN3	199
9.100.	Additional information for the additional contact information - IN4	200
9.101.	Respondent List (XML) - RLS	201
9.102.	Candidate Sequence ID - CSI	203
9.103.	Candidate Manual Verification Indicator - MVI	204
9.104.	Candidates Total Quantity - CTQ	205
9.105.	Transaction Category Code - CAC	206
9.106.	Transaction Search Results Code - SRC	207
9.107.	Error Message (XML) - ERM	208
9.108.	Error code - ECO	209
9.109.	Error Field Mnemonic Code - EFM	210
9.110.	Error Message Text - EMT	211
9.111.	Father's name - FFN	212
9.112.	Mother's family name - MMN	214
9.113.	Latent Matching Position - LMP	216

9.114.	Latent Matching Position – Search - LMS	217
9.115.	Latent Matching Position – Candidate - LMC	218
9.116.	INTERPOL Reference Number - IRN	219
9.117.	National Person Inquiry Identifier - NPI	220
9.118.	Record Expiration Date - EXP	221
9.119.	Latent Unique Identifier - LID	222
9.120.	Result Determination Mode - RDM	223
9.121.	Civil Description Code - CRF	224
9.122.	Civil Description Text - COT	225
9.123.	Field Mandatoriness in User-defined Descriptive Text Record	226
10.	Minutiae Data Record (aka Type 9)	229
10.1.	Package Minutiae Record (XML)	230
10.2.	XML Record Category Code - XRCC	232
10.3.	Information Designation Character - IDC	233
10.4.	Impression Type - IMP	234
10.5.	Minutia Format (XML) - FMT	235
10.6.	User-Defined Fields - RMU	236
10.7.	INCITS Minutiae (XML)	237
10.8.	CBEFF Format Owner - CFO	239
10.9.	CBEFF Format Type - CFT	240
10.10.	CBEFF Product Identifier - CPI	241
10.11.	M1 Capture Equipment ID - CEI	242
10.12.	Appendix F Status - AFS	244
10.13.	Capture Equipment ID - CID	245
10.14.	Finger Impression Image (XML)	246
10.15.	M1 Horizontal Line Length - HLL	248
10.16.	M1 Vertical Line Length - VLL	249
10.17.	M1 Scale Units - SLC	250
10.18.	M1 Transmitted Horizontal Pixel Scale - THPS	251
10.19.	M1 Transmitted Vertical Pixel Scale - TVPS	252
10.20.	M1 Finger View - FVW	253
10.21.	M1 Friction Ridge Generalized Position - FGP	254
10.22.	M1 Friction Ridge Quality Data - FQD	255
10.23.	Quality Value - QVU	256
10.24.	Algorithm Vendor Identification - QAV	257
10.25.	Algorithm Product Identification - QAP	258
10.26.	M1 Number of Minutiae - NOM	259
10.27.	M1 Finger Minutiae Data (XML) - FMD	260
10.28.	Minutia Index Number - MAN	261
10.29.	INCITS Minutia Location (XML)	262
10.30.	X Coordinate - MXC	263
10.31.	Y Coordinate - MYC	264
10.32.	Minutia Angle - MAV	265
10.33.	Minutia Type - M1M	266
10.34.	Quality of Minutia - QOM	267
10.35.	M1 Ridge Count Information - RCI	268
10.36.	Ridge Count Extraction Method - REM	269
10.37.	Minutiae Ridge Count Item (XML)	270
10.38.	Center Minutia Index Number - CMI	271
10.39.	Neighboring Minutia Index Number - NMN	272
10.40.	Number of Ridges Crossed - NRC	273

10.41.	M1 Core Information - CIN	274
10.42.	X Coordinate - XCC	275
10.43.	Y Coordinate - YCC	276
10.44.	Angle of the Core - ANGC	277
10.45.	M1 Delta Information - DIN	278
10.46.	X Coordinate - XCD	279
10.47.	Y Coordinate - YCD	280
10.48.	First, Second, and Third Angles of the Delta	281
10.49.	Extended Feature Set Minutiae (XML)	282
10.50.	EFS Region of Interest - ROI	284
10.51.	ROI Width - EWI	285
10.52.	ROI Height - EHI	286
10.53.	ROI Horizontal Offset - EHO	287
10.54.	ROI Vertical Offset - EVO	288
10.55.	ROI Polygon (XML) - ROP	289
10.56.	Image Segment Vertex (XML) - ROP	290
10.57.	Image Location Horizontal Coordinate Measure (XML) - ROP	291
10.58.	Image Location Vertical Coordinate Measure (XML) - ROP	292
10.59.	EFS Orientation - ORT	293
10.60.	Direction - EOD	294
10.61.	Uncertainty - EUC	295
10.62.	EFS Finger, Palm, Plantar Position - FPP	296
10.63.	Friction Ridge Generalized Position - FGP	297
10.64.	Segment Polygon (XML) - SGP	298
10.65.	Image Segment Vertex (XML) - SGP	299
10.66.	Image Location Horizontal Coordinate Measure (XML) - SGP	300
10.67.	Image Location Vertical Coordinate Measure (XML) - SGP	301
10.68.	EFS Feature Set Profile - FSP	302
10.69.	EFS Pattern Classification - PAT	303
10.70.	General Class - GCF	304
10.71.	Subclass - SUB	305
10.72.	Whorl-Delta Relationship - WDR	306
10.73.	EFS Ridge Quality Map (XML) - RQM	307
10.74.	Ridge Quality Map Format (XML) - RQF	308
10.75.	Grid Size - GSZ	309
10.76.	Ridge Quality Data Format - RDF	310
10.77.	EFS Ridge Flow Map (XML) - RFM	311
10.78.	EFS Ridge Flow Map Format (XML) - RFF	312
10.79.	Sampling Frequency - SFQ	313
10.80.	Ridge Flow Data Format - RDF	314
10.81.	EFS Ridge Wavelength Map (XML) - RWM	315
10.82.	EFS Ridge Wavelength Map Format (XML) - RWF	316
10.83.	Sampling Frequency - FWS	317
10.84.	Data Format - FDF	318
10.85.	EFS Tonal Reversal - TRV	319
10.86.	EFS Possible Lateral Reversal - PLR	320
10.87.	EFS Friction Ridge Quality Metric - FQM	321
10.88.	Quality Value - QVU	322
10.89.	Algorithm Vendor Identification - QAV	323
10.90.	Algorithm Product Identification - QAP	324
10.91.	EFS Possible Growth or Shrinkage - PGS	325
10.92.	Growth or Shrinkage Type - TGS	326

10.93.	Growth or Shrinkage Comment (XML) - CGS	327
10.94.	EFS Cores (XML) - COR	328
10.95.	X Coordinate - CXC	329
10.96.	Y Coordinate - CYC	330
10.97.	Direction - CDI	331
10.98.	Radius of Position Uncertainty - RPU	332
10.99.	Direction Uncertainty - DUY	333
10.100.	EFS Deltas (XML) - DEL	334
10.101.	X Coordinate - DXC	336
10.102.	Y Coordinate - DYC	337
10.103.	Direction Up - DUP	338
10.104.	Direction Left - DLF	339
10.105.	Direction Right - DRT	340
10.106.	Type - DTP	341
10.107.	Radius of Position Uncertainty - RPU	342
10.108.	Direction Uncertainty Up - DUU	343
10.109.	Direction Uncertainty Left - DUL	344
10.110.	Direction Uncertainty Right - DUR	345
10.111.	EFS Core-Delta Ridge Counts - CDR	346
10.112.	Core Index - CIX	347
10.113.	Delta index - DIX	348
10.114.	Min Ridge Count - MNRC	349
10.115.	Max Ridge Count - MXRC	350
10.116.	EFS Center Point of Reference - CPR	351
10.117.	Method - CPM	352
10.118.	X Coordinate - PXC	353
10.119.	Y Coordinate - PYC	354
10.120.	Radius of Position Uncertainty - CRU	355
10.121.	EFS Distinctive Features (XML) - DIS	356
10.122.	Distinctive Feature Type - DIT	357
10.123.	Distinctive Features Polygon (XML) - DFP	358
10.124.	Image Segment Vertex (XML) - DFP	359
10.125.	Image Location Horizontal Coordinate Measure (XML) - DFP	360
10.126.	Image Location Vertical Coordinate Measure (XML) - DFP	361
10.127.	Distinctive Features Comment - DFC	362
10.128.	EFS No Cores Present (XML) - NCOR	363
10.129.	EFS No Deltas Present (XML) - NDEL	364
10.130.	EFS No Distinctive Features Present (XML) - NDIS	365
10.131.	EFS Minutiae (XML) - MIN	366
10.132.	X Coordinate - MXC	367
10.133.	Y Coordinate - MYC	368
10.134.	Theta Degrees - MTD	369
10.135.	Minutia Type - MTY	370
10.136.	Radius of Position Uncertainty - MRU	371
10.137.	Minutiae Direction of Uncertainty - MDU	372
10.138.	EFS Minutiae Ridge Count Algorithm - MRA	373
10.139.	EFS Minutiae Ridge Counts - MRC	374
10.140.	Minutia Index A - MIA	375
10.141.	Minutia Index B - MIB	376
10.142.	Ridge Count - MIR	377
10.143.	Reference Number - MRN	378
10.144.	Residual - MRS	379

10.145. EFS No Minutia Present (XML) - NMIN	380
10.146. EFS Ridge Count Confidence - RCC	381
10.147. Minutia Location Point (XML)	382
10.148. X Coordinate Point A - ACX	383
10.149. Y Coordinate Point A - ACY	384
10.150. Minutia Location Reference Point (XML)	385
10.151. X Coordinate Point B - BCX	386
10.152. Y Coordinate Point B - BCY	387
10.153. Method of Ridge Counting - MORC	388
10.154. Confidence Value - MCV	389
10.155. EFS Dots (XML) - DOT	390
10.156. Dot X Coordinate - DOX	391
10.157. Dot Y Coordinate - DOY	392
10.158. Dot Length - DOL	393
10.159. EFS Incipient Ridges (XML) - INR	394
10.160. Minutia Location Point (XML)	395
10.161. X Coordinate Point 1 - X1C	396
10.162. Y Coordinate Point 1 - Y1C	397
10.163. Minutia Location Reference Point (XML)	398
10.164. X Coordinate Point 2 - X2C	399
10.165. Y Coordinate Point 2 - Y2C	400
10.166. EFS Creases and Linear Discontinuities (XML) - CLD	401
10.167. Minutia Location Point (XML)	402
10.168. X Coordinate Point 1 - X1D	403
10.169. Y Coordinate Point 1 - Y1D	404
10.170. Minutia Location Reference Point (XML)	405
10.171. X Coordinate Point 2 - X2D	406
10.172. Y Coordinate Point 2 - Y2D	407
10.173. Type - TPD	408
10.174. EFS Ridge Edge Features (XML) - REF	409
10.175. X Coordinate - CLX	410
10.176. Y Coordinate - CLY	411
10.177. Type - CLT	412
10.178. EFS No Pores Present (XML) - NPOR	413
10.179. EFS Pores (XML) - POR	414
10.180. X Coordinate - POX	415
10.181. Y Coordinate - POY	416
10.182. EFS No Dots Present (XML) - NDOT	417
10.183. EFS No Incipient Ridges Present (XML) - NINR	418
10.184. EFS No Creases Present (XML) - NCLD	419
10.185. EFS No Ridge Edge Features Present (XML) - NREF	420
10.186. EFS Method of Feature Detection - MFD	421
10.187. Field - FIE	422
10.188. Method - FME	423
10.189. Algorithm Vendor - FAV	424
10.190. Algorithm - FAL	425
10.191. Minutiae Examiner (XML)	426
10.192. Examiner Surname - ESN	427
10.193. Examiner Given Name - EGN	428
10.194. Examiner Affiliation - EAF	429
10.195. Date and Time (XML) - EMT	430
10.196. Notes - NTS	431

10.197. EFS Comment - COM	432
10.198. EFS Latent Processing Method - LPM	433
10.199. EFS Examiner Analysis Assessment - EAA	434
10.200. Value Assessment Code - AAV	435
10.201. Minutiae Examiner (XML)	436
10.202. Examiner Last Name - ALN	437
10.203. Examiner First Name - AFN	438
10.204. Examiner Affiliation - AAF	439
10.205. Date and Time (XML) - AMT	440
10.206. Comment - ACM	441
10.207. Analysis Complexity Flag - CXF	442
10.208. EFS Evidence of Fraud - EOF	443
10.209. Fraud Type - FRA	444
10.210. Comment - CFD	445
10.211. EFS Latent Substrate - LSB	446
10.212. Code - CLS	447
10.213. Object/Substrate Description - OSD	448
10.214. EFS Latent Matrix - LMT	449
10.215. Code - TOM	450
10.216. Comment - CLA	451
10.217. EFS Local Quality Issues - LQI	452
10.218. Type - LQT	453
10.219. Image Segment Polygon (XML) - LQP	454
10.220. Image Segment Vertex (XML) - LQP	455
10.221. Image Location Horizontal Coordinate Measure (XML) - LQP	456
10.222. Image Location Vertical Coordinate Measure (XML) - LQP	457
10.223. Comment - LQC	458
10.224. EFS Area of Correspondence - AOC	459
10.225. IDC Reference - CIR	460
10.226. Image Segment Polygon (XML) - AOP	461
10.227. Image Segment Vertex (XML) - AOP	462
10.228. Image Location Horizontal Coordinate Measure (XML) - AOP	463
10.229. Image Location Vertical Coordinate Measure (XML) - AOP	464
10.230. Comment - CAC	465
10.231. EFS Corresponding Points or Features - CPF	466
10.232. Label - COL	467
10.233. Type of Correspondence - TOC	468
10.234. Corresponding Field Number - CFN	469
10.235. Corresponding Field Occurrence - FOC	470
10.236. Corresponding X Coordinate - CXC	471
10.237. Corresponding Y Coordinate - CYC	472
10.238. Comment - COC	473
10.239. EFS Examiner Comparison Determination - ECD	474
10.240. IDC Reference - EDC	475
10.241. Determination - EDE	476
10.242. Work in Progress - WIP	477
10.243. Minutiae Examiner (XML)	478
10.244. Examiner Last Name - ELN	479
10.245. Examiner First Name - EFN	480
10.246. Examiner Affiliation - EAF	481
10.247. Date and Time (XML) - DTG	482
10.248. Comment - CZZ	483

10.249.	Complex Comparison Flag - CCF	484
10.250.	EFS Relative Rotation of Corresponding Print - RRC	485
10.251.	Rotation IDC Reference - RIR	486
10.252.	Relative Overall Rotation - ROR	487
10.253.	EFS Skeletonized Image - SIM	488
10.254.	Minutiae Image Ridge Path Representation (XML) - RPS	489
10.255.	Minutiae Ridge Path Segment (XML) - RPS	490
10.256.	Image Segment Vertex (XML) - RPS	491
10.257.	Image Location Horizontal Coordinate Measure (XML) - RPS	492
10.258.	Image Location Vertical Coordinate Measure (XML) - RPS	493
10.259.	Field Mandatoriness in Minutiae Data Record	494
11.	Photographic Body Part Imagery Record (aka Type 10)	503
11.1.	Package Facial And SMT Image Record (XML)	504
11.2.	XML Record Category Code - XRCC	506
11.3.	Information Designation Character - IDC	507
11.4.	Face or Physical Feature Indication (XML)	508
11.5.	Image Type - IMT	510
11.6.	Capture Organization (XML)	511
11.7.	Source Agency - SRC	512
11.8.	Photo Capture Date (XML) - PHD	513
11.9.	Horizontal Line Length - HLL	514
11.10.	Vertical Line Length - VLL	515
11.11.	Scale Units - SLC	516
11.12.	Transmitted Horizontal Pixel Scale - THPS	517
11.13.	Transmitted Vertical Pixel Scale - TVPS	518
11.14.	Compression Algorithm - CGA	519
11.15.	Color Space - CSP	520
11.16.	Subject Acquisition Profile - SAP	521
11.17.	Subject Pose - POS	522
11.18.	Pose Offset Angle - POA	523
11.19.	Body Part Image - DATA	524
11.20.	Field Mandatoriness in Photographic Imagery Record	525
12.	Friction-ridge Latent Image Record (aka Type 13)	526
12.1.	Package Latent Image Record (XML)	527
12.2.	XML Record Category Code - XRCC	529
12.3.	Information Designation Character - IDC	530
12.4.	Image Type (XML)	531
12.5.	Impression Type - IMP	533
12.6.	Capture Organization (XML)	535
12.7.	Source Agency - SRC	537
12.8.	Latent Capture Date (XML) - LCD	539
12.9.	Horizontal Line Length - HLL	541
12.10.	Vertical Line Length - VLL	543
12.11.	Scale Units - SLC	545
12.12.	Transmitted Horizontal Pixel Scale - THPS	547
12.13.	Transmitted Vertical Pixel Scale - TVPS	549
12.14.	Compression Algorithm - CGA	551
12.15.	Bits Per Pixel - BPX	553
12.16.	Friction Ridge Generalized Position - FGP	555
12.17.	Scanned Horizontal Pixel Scale - SHPS	557

12.18.	Scanned Vertical Pixel Scale - SVPS	559
12.19.	Comment - COM	561
12.20.	Latent Quality Metric - LQM	563
12.21.	Friction Ridge Metric Position - FRMP	565
12.22.	Quality Value - QVU	567
12.23.	Algorithm Vendor ID - QAV	569
12.24.	Algorithm Product Identification - QAP	571
12.25.	Friction Ridge Capture Technology - FCT	573
12.26.	Latent Friction Ridge Image - DATA	575
12.27.	Field Mandatoriness in Friction-ridge Latent Image Record	577
13.	Fingerprint Image Record (aka Type 14)	578
13.1.	Package Fingerprint Image Record (XML)	579
13.2.	XML Record Category Code - XRCC	581
13.3.	Information Designation Character - IDC	582
13.4.	Finger Impression Image (XML)	583
13.5.	Impression Type - IMP	585
13.6.	Capture Organization (XML)	586
13.7.	Source Agency - SRC	587
13.8.	Fingerprint Capture Date (XML) - FCD	588
13.9.	Horizontal Line Length - HLL	589
13.10.	Vertical Line Length - VLL	590
13.11.	Scale Units - SLC	591
13.12.	Transmitted Horizontal Pixel Scale - THPS	592
13.13.	Transmitted Vertical Pixel Scale - TVPS	593
13.14.	Compression Algorithm - CGA	594
13.15.	Bits Per Pixel - BPX	595
13.16.	Friction Ridge Generalized Position - FGP	596
13.17.	Amputated or Bandaged - AMP	597
13.18.	Friction Ridge Amputated or Bandaged Position - FRAP	598
13.19.	Amputated or Bandaged Code - ABC	599
13.20.	Finger Segment Position - SEG	600
13.21.	Friction Ridge Segment Position - FRSP	602
13.22.	Left Horizontal Coordinate Value - LHC	603
13.23.	Right Horizontal Coordinate Value - RHC	604
13.24.	Top Vertical Coordinate Value - TVC	605
13.25.	Bottom Vertical Coordinate Value - BVC	606
13.26.	Alternate Finger Segment Position(s) - ASEG	607
13.27.	Friction Ridge Alternate Segment Position - FRAS	609
13.28.	Number of Points - NOP	610
13.29.	Position Polygon Vertex (XML)	611
13.30.	Horizontal Point Offset (XML) - HPO	612
13.31.	Vertical Point Offset (XML) - VPO	613
13.32.	Device Monitoring Mode - DMM	614
13.33.	Subject Acquisition Profile - Fingerprint - FAP	615
13.34.	Friction Ridge Capture Technology - FCT	616
13.35.	Fingerprint Image - DATA	617
13.36.	Field Mandatoriness in Fingerprint Image Record	618
14.	Palmprint Image Record (aka Type 15)	621
14.1.	Package Palmprint Image Record (XML)	622
14.2.	XML Record Category Code - XRCC	624

14.3.	Information Designation Character - IDC	625
14.4.	Palmprint Image (XML)	626
14.5.	Impression Type - IMP	628
14.6.	Capture Organization (XML)	629
14.7.	Source Agency - SRC	630
14.8.	Palmprint Capture Date (XML) - PCD	631
14.9.	Horizontal Line Length - HLL	632
14.10.	Vertical Line Length - VLL	633
14.11.	Scale Units - SLC	634
14.12.	Transmitted Horizontal Pixel Scale - THPS	635
14.13.	Transmitted Vertical Pixel Scale - TVPS	636
14.14.	Compression Algorithm - CGA	637
14.15.	Bits Per Pixel - BPX	638
14.16.	Friction Ridge Generalized Position - FGP	639
14.17.	Amputated or Bandaged - AMP	640
14.18.	Friction Ridge Amputated or Bandaged Position - FRAP	641
14.19.	Amputated or Bandaged Code - ABC	642
14.20.	Palm Segment Position - SEG	643
14.21.	Friction Ridge Segment Position - FRSP	645
14.22.	Left Horizontal Coordinate Value - LHC	646
14.23.	Right Horizontal Coordinate Value - RHC	647
14.24.	Top Vertical Coordinate Value - TVC	648
14.25.	Bottom Vertical Coordinate Value - BVC	649
14.26.	Subject Acquisition Profile – Palmprint - PAP	650
14.27.	Friction Ridge Capture Technology - FCT	651
14.28.	Palmprint Image - DATA	652
14.29.	Field Mandatoriness in Palmprint Image Record	653
15.	Source Representation Record (aka Type 20)	654
15.1.	Package Source Representation Record (XML)	655
15.2.	XML Record Category Code - XRCC	657
15.3.	Information Designation Character - IDC	658
15.4.	SRN Cardinality - CAR	659
15.5.	Source Type (XML)	660
15.6.	Biometric/Image Capture Detail (XML)	661
15.7.	Capture Organization (XML)	663
15.8.	Source Agency - SRC	665
15.9.	Source Representation Date (XML) - SRD	667
15.10.	Horizontal Line Length - HLL	669
15.11.	Vertical Line Length - VLL	670
15.12.	Scale Units - SLC	671
15.13.	Transmitted Horizontal Pixel Scale - THPS	672
15.14.	Transmitted Vertical Pixel Scale - TVPS	673
15.15.	Compression Algorithm - CGA	674
15.16.	Bits Per Pixel - BPX	675
15.17.	Color Space - CSP	676
15.18.	Acquisition Source - AQS	677
15.19.	Acquisition Source Type - AQT	678
15.20.	Analog to Digital Conversion - A2D	679
15.21.	Acquisition Special Characteristics - AQSC	680
15.22.	Source Representation Format - SFT	681
15.23.	File Type - FTY	682

15.24.	Decoding Instructions - DEI	683
15.25.	Source Representation Number - SRN	684
15.26.	Source Representation Data - DATA	685
15.27.	Field Mandatoriness in Source Representation Record	687
A.	Code Tables	688
A.1.	Table of Amputated or Bandaged Codes	689
A.2.	Table of Direction Uncertainty Codes	690
A.3.	Table of Acquisition Source Type Codes	691
A.4.	Table of Source Cardinality Codes	692
A.5.	Table of Appendix F Status Codes	693
A.6.	Table of Image Compression Algorithm Labels	694
A.7.	Table of Civil Codes	695
A.8.	Table of Permanent Flexion Crease Codes	696
A.9.	Table of Feature Field Number Codes	697
A.10.	Table of Feature Correspondance Codes	698
A.11.	Table of Center Location Method Codes	699
A.12.	Table of CSI Codes	700
A.13.	Table of CSN Codes	701
A.14.	Table of Image Color Space Codes	702
A.15.	Table of Delta Category Codes	703
A.16.	Table of Distinctive Feature Type Codes	704
A.17.	Table of Device Monitoring Mode Codes	705
A.18.	Table of Value Assessment Codes	706
A.19.	Table of Determination Result Codes	707
A.20.	Table of EFS Feature Set Profile Codes	708
A.21.	Table of Fraud Type Codes	709
A.22.	Table of Error Codes	710
A.23.	Table of Fingerprint Acquisition Profiles	711
A.24.	Table of Friction Ridge Capture Technology Codes	712
A.25.	Table of Generalized Fingerprint Position Codes	714
A.26.	Table of XML Generalized Fingerprint Position Codes	716
A.27.	Table of Minutiae Type Codes	717
A.28.	Table of Minutiae Quality Codes	718
A.29.	Table of Off-Center Fingerprint Codes	719
A.30.	Table of File Type Codes	720
A.31.	Table of Fingerprint Impression Types	721
A.32.	Table of Type of Substance Codes	723
A.33.	Table of Latent Processing Method Codes	724
A.34.	Table of Quality Issue Codes	725
A.35.	Table of Latent Substrate Codes	726
A.36.	Table of Feature Detection Method Codes	727
A.37.	Table of Minutiae Type Codes	728
A.38.	Table of Minutiae Ridge Count Algorithm Codes	729
A.39.	Table of Minutiae Residual Codes	730
A.40.	Table of Offense Codes	731
A.41.	Table of Palmprint Acquisition Profiles	733
A.42.	Table of Pattern Classification Codes	734
A.43.	Table of Pattern Classification Subcodes	735
A.44.	Table of Whorl-Delta Relationship Codes	736
A.45.	Table of Growth or Shrinkage Type Codes	737
A.46.	Table of Possible Lateral Reversal Codes	738

A.47.	Table of Subject Pose Codes	739
A.48.	Table of Quality Value Codes	740
A.49.	Table of Method of Ridge Counting Codes	741
A.50.	Table of Ridge Count Extraction Method Codes	742
A.51.	Table of Result Determination Mode Codes	743
A.52.	Table of Record Type Codes	744
A.53.	Table of Type of Feature Codes	745
A.54.	Table of Ridge Flow Data Format Codes	746
A.55.	Table of Ridge Quality Data Format Codes	747
A.56.	Table of Ridge Quality Map Codes	748
A.57.	Table of Subject Acquisition Profile Codes	749
A.58.	Table of Sex Codes	750
A.59.	Table of Scale Units Codes	751
A.60.	Table of Types of Transactions	752
A.61.	Table of Tonal Reversal Codes	753

Glossary

Latent Friction-ridge Image

An unknown (partial) fingerprint or palmprint image acquired from a crime scene. It may also be referred to as “Latent Print”.

Machine-readable Tables

A tabular format of the definition of relevant record elements associated with the standard, in a machine readable format. A version for the Interpol Implementation has been produced and available via Interpol (and included with the associated package containing this electronic document). Its layout and format is based on the MRT produced for the umbrella ANSI/NIST-ITL standard (available from NIST).

National Information Exchange Model

A flexible Information model defined and used by US government agencies to exchange information via XML data format.

National Institute for Standards and Technology

Standardizing body for the US government, publisher of the ANSI/NIST-ITL standard for biometric data.

Tenprint

A full set of fingerprint images, acquired from a known or unknown individual. From a law enforcement agency standpoint, a tenprint is normally composed of at least 10 rolled fingerprint images, 4 plain fingerprint images (left slap, right slap and 2 thumbs) and 2 lower palms. It might be completed by other images, such as writer’s palms or upper palms. For the immigration agencies, the set is often reduced to 10 segmented plain fingerprint images and/or 4 plain fingerprint images (left slap, right slap and 2 thumbs).

Acronyms

AFIS

Automated Fingerprint Identification System.

AFR

Automatic Fingerprint Recognition.

ANSI

American National Standards Institute.

IAEWG

INTERPOL AFIS Expert Working Group.

IEPD

Information Exchange Package Description.

INT-I

INTERPOL Implementation.

INTERPOL

International Criminal Police Organization.

ISO

International Organization for Standardization.

MRT

Machine-readable Table.

NBS

National Bureau of Standards.

NIEM

[National Information Exchange Package.](#)

NIST

[National Institute for Standards and Technology.](#)

SMT

Scars, Marks and Tattoos.

TOT

Type of Transaction.

Revision history

06.00.00a (26/04/2018) — 1st public draft version

06.00.00b (09/11/2018) — 2nd public draft version

- Changed the title to focus on the exchange of biometrics rather than on ANSI/NIST ([issue #1](#))
- Changed [2.010] CRN field description to make it clear that it is mandatory only if [2.011] is absent ([issue #2](#))
- Changed [2.010] CRN and [2.011] ORN: add NPS in the mandatoriness rules ([issue #3](#))
- Removed table ISO3166-1 Alpha-3 code, keep only a list to the current list on the ISO website ([issue #4](#))
- Changed [2.011] ORN presence condition from Optional to Dependent ([issue #10](#))
- Changed [9.331] MIN to increase max occur from 999 to 9999 ([issue #11](#))
- Changed from [1.015-A] DCS/CSN and [1.015-B] DCS/CSI to [1.015-A] DCS/CSI and [1.015-B] DCS/CSN (fields where in the wrong order) ([issue #15](#))
- Changed from [1.015-A] DCS/CSN and [1.015-B] DCS/CSI to [1.015-A] DCS/CSI and [1.015-B] DCS/CSN (fields where in the wrong order) ([issue #15](#))
- Changed [2.012] MN1, [2.013] MN2, [2.014] MN3, [2.015] MN4 and [2.016] MN5 from simple text fields to structured fields ([issue #18](#))
- Fixed min occurrence and max occurrence for various Set_X fields where they were not specified.
- Fixed max occurrence of [2.011] ORN (was 10, should be 1) ([issue #5](#), [issue #6](#) and [issue #7](#))
- Added [14.021] SEG, [14.025] ASEG and [15.021] SEG ([issue #13](#) and [issue #14](#))
- Fixed the XML samples ([issue #9](#))
- Fixed the valid examples for [1.009] TCN and [1.010] TCR ([issue #22](#))

06.00.00 (12/03/2020) — 1st released version

- Fixed invalid regular expression for [1.009] TCN and [1.010] TCR ([issue #23](#))
- Fixed valid example for [1.013] DOM ([issue #24](#))

- Fixed the description for [2.023:X3-A] OB5 to [2.023:X3-G] OB11 ([issue #25](#))
- Added the description of ANSU Data Types ([issue #26](#) and [issue #27](#))
- Fixed valid example for [1.007] DAI
- Fixed valid example for [14.008] SLC

06.00.01 (31/08/2020) — 2nd released version

- Changed description on second page

1. The History and the Spirit

In 1986 the American National Bureau of Standards published a standard to facilitate the interchange of fingerprint image information entitled "Data Format for the Interchange of Fingerprint Information" (ANSI/NBS-ICST 1-1986). Following a relatively exhaustive review procedure which included the UK Home Office together with US and Canadian law enforcement agencies, this was revised by the American National Institute of Standards and Technology (NIST) and issued as ANSI/NIST-CSL 1-1993. In 1997 the standard was expanded to handle facial images, - scar, mark and tattoo (SMT) image data. This expansion was issued as ANSI/NIST-ITL 1a-1997. In September 1998 both standards were revised and merged into the ANSI/NIST-ITL 1-2000 enhanced with additional field and record definitions.

ANSI/NIST-ITL 1-2007 and ANSI/NIST-ITL 1-2008 are major updated versions with a new format in XML. This format is defined by the W3C XML and is the most popular language used for exchanging data between remote computer systems such as an AFIS.

The present document, the INTERPOL Implementation (INT-I), has been written with the intention of supplementing the ANSI/NIST-ITL 1-2011 (Update 2015) publication for the guidance of members of the International Criminal Police Organization (INTERPOL).

INTERPOL facilitates twice a year an AFIS Expert Working Group (IAEWG) meeting where representatives from selected member countries can discuss international fingerprint exchange. Experiences are shared through real cases and best practices are discussed with needs being defined to improve the international fingerprint exchange and processing.

The ANSI/NIST INT-I standard is defined and endorsed by the IAEWG.

The INT-I has been drafted noting the following general points:

Openness The INT-I has been drafted to ensure openness and hence any subsequent systems using the INT-I are assured the highest level of impartiality.

Non-intrusiveness The INT-I has been drafted with a minimum level of mandatory requirements and many optional elements. There is no attempt to impose operational procedures and constraints onto any system which conforms to the INT-I.

Interoperability The INT-I allows for the transfer of fingerprint and other biometric information between different systems. However, in a situation where there is an incompatibility between the two (transmitter and receiver), it is the responsibility of the transmitter to ensure that the transmitted data is re-formatted to comply with the standard. The use of XML encoding of the data as introduced in this document further increases interoperability with formerly non INT-I enabled systems.

Wide usage The INT-I has been designed to encompass the exchange of a wide variety of fingerprint information, and not just that required by an AFIS.

It should be noted that the records described in the ANSI/NIST standard and INT-I are not intended for manual

entry and interpretation: rather they are intended for transmission of information between computers.

Also, the standard describes the content of the NIST file, but not how this file is transmitted from one system to another. This aspect should be covered in other system-specific documentations.

It is also important to note that some TOTs, and elements within records, may not be appropriate for certain transactions between particular agencies. For example, many agencies may not allow a remote site to add a record to its database, or there may be national legal objections to sending respondent images over a wide area network before they have been verified. However, in the spirit of open standards, and with the aim of excluding only the absolute minimum of information exchange, all such transactions are specified in INT-I but with the expectation that they could be blocked by the systems involved.

The following section describes the general structure of the ANSI/NIST standard and goes on to describe the various record types. Although this document describes a XML compatible format the nomenclature for the elements will be based on the existing previous non-XML versions of this standard. Elements are referenced through their assigned numeric value or mnemonic even though those values might never appear in a real INT-I transaction. Their use allows implementers to map data between XML and non-XML versions of the standard for conversion.

2. How to Apply the INTERPOL Implementation

The present document sets limits to open definitions and answers the open questions of the original standard ANSI/NIST-ITL 1-2011 (Update 2015). To this effect, this document does not repeat the well-defined parts of the underlying standard and it should be referred to for a complete definition. However, the associated XML schema defines the structure and the content of the complete XML-file. The structure and the content must be respected for a proper creation of XML-files for the international exchange.

In the following chapters, all references to “Type X” or “Fields X.XXX” are provided for reference to former tagged ANSI/NIST INT-I. These references can be used if you are looking to convert files from previous versions of the standard to this new XML version.

In conclusion, the creation of a XML-file according to the INTERPOL Implementation is done with this document, the underlying standard and the schema.

3. Content of the **IEPD**

The INTERPOL implementation for ANSI/NIST package contains the following items:

- this document;
- the XSD files describing the implementation, under the directory XMLschemas. The main xsd against which the XML must be validated is the file XMLschemas\int-i\1.0\int-i.xsd. Extracts of the relevant parts of schemas for the nc, biom, itl and iso3166 namespace elements are also included: the delivered XSD files are sufficient to validate a NIST file;
- XML sample files, found under the directory XMLsamples;
- the [Machine-readable Table \(MRT\)](#) file describing the INTERPOL format. This file serves as a reference and is used to generate this document. It is delivered as an Excel spreadsheet as well as in CSV format;
- the ANSI/NIST umbrella document this standard is derived from.

4. Data Conventions

4.1. XML Namespaces

4.1.1. Forewords

This version of the INTERPOL implementation is based on the version 2.1 of the NIEM standard.

At the time of the writing of this document, only NIEM 2.1 and NIEM 3.1 were supported by ANSI/NIST umbrella and NIEM 3.1 was lacking some essential type (namely the ISO 3166-1 Alpha 3 country codes). The support of NIEM 4.0 in the umbrella standard came too late to be integrated into this version of INTERPOL's implementation.

We intend to follow if possible the new version of the NIEM standard. This could obviously lead to a new version of this implementation.

4.1.2. nc

[National Information Exchange Model \(NIEM\)](#) core elements are basic elements taken from the NIEM standard. The definitions can be found in the file `XMLschemas/subset/niem/niem-core/2.0/niem-core.xsd` of the [Information Exchange Package Description \(IEPD\)](#). Elements in this workspace describe basic alphanumeric data such as names, locations or dates. In many cases the elements in the nc namespace are used as basis for extensions in the int-i namespace.

4.1.3. biom

biom elements are elements taken from the biometric domain NIEM standard. The definitions can be found in the file `XMLschemas/subset/niem/domains/1.0/biometrics.xsd` of the [IEPD](#). Elements in this workspace describe basic biometric types, such as Fingerprint, Minutiae, ...

4.1.4. itl

itl elements are taken from the ANSI/NIST-ITL 2011 Biometric Information Exchange Package. The definition can be found in the file `XMLschemas/exchange/itl.xsd` of the [IEPD](#).

4.1.5. iso3166

iso3166 elements are taken from the ISO 3166-1 standard. The definition can be found in the file `XMLschemas/subset/niem/iso_3166/2.0/iso_3166.xsd` of the [IEPD](#).

4.1.6. int-i

int-i elements are specific to the INTERPOL implementation of the standard. The definition can be found in the file `XMLschema/int-i/1.0/int-i.xsd` of the [IEPD](#).

4.2. Basic Data Types

4.2.1. Date and Time Types

nc:DateRepresentation

The base type for all date related fields is the abstract type `nc:DateRepresentation`. (see [NIEM core namespace](#)). Possible substitutions are `nc:Date` and `nc:DateTime`, which in turn are `niem-xsd:date` and `niem-xsd:dateTime`.

`nc:Date` and `nc:DateTime` both follow ISO 8601 format (full description can be found at this location https://en.wikipedia.org/wiki/ISO_8601). This implementation nevertheless introduces two limitations:

- it is not allowed to specify milliseconds;
- it is not allowed to specify a timezone other than UTC.

Practically, this means that:

- a date should match this regular expression*:

$$\backslash d\{4\}-\backslash d\{2\}-\backslash d\{2\}$$

, that is to say that the date should be expressed in the following format

$$YYYY - MM - DD$$

, where YYYY is the year on four digits, MM is the month on two digits and DD is the day on two digits.

- a `dateTime` should match this regular expression:

$$\backslash d\{4\}-\backslash d\{2\}-\backslash d\{2\}T\backslash d\{2\}:\backslash d\{2\}:\backslash d\{2\}(Z)\{0,1\}$$

, that is to say that the timestamp should be expressed in the following format

$$YYYY - MM - DDTHH : MM : SSZ$$

. The Z denotes an UTC timestamp and should not be present if the timestamp is expressed in the local time zone.

*In the regular expression syntax, `\d` represents a digit (from 0 to 9), and the number between curly brackets represents the number of repetitions. See https://en.wikipedia.org/wiki/Regular_expression for more information.

For instance, the following date and dateTime are valid:

```
2017-07-26
2017-07-26T16:48:52
2017-07-26T14:48:52Z
```

The following date and dateTime are on the other hand invalid:

```
2017-07-26T16:48
2017-07-26T16:48:52+02:00
2017-07-26T16:48:52.023
```

4.2.2. ISO 3166-1 Alpha-3 Country Codes Type

The base type for all country-code related fields is the ISO 3166-1 Alpha-3 standard, which assigns a unique 3-letter code to each country.

The previous version of the ANSI/NIST INTERPOL implementation (version 5.02) was using ISO 3166-1 Alpha-2. This new implementation uses the ISO 3166-1 Alpha-3 standard.

The change from Alpha-2 to Alpha-3 has been decided to avoid the ambiguities of Alpha-2, in which some codes have been recycled over time: for instance, CS originally meant Czechoslovakia, and was later assigned to Serbia and Montenegro.

For the most current code list, check <https://www.iso.org/iso-3166-country-codes.html>.

4.2.3. int-i ISO 3166-1 Alpha-3 Country Codes Type

This base type is an extension of above type with INTERPOL's proprietary codes. The following codes have been added to the standard list:

Table 4.1.: Extended ISO 3166-1 Alpha-3 Codes

Extended ISO Code	Organization
ZZZ ¹	All
XPO	INTERPOL
EPO	EUROPOL
UNO	United Nations
ICC	International Criminal Court

¹The ZZZ code is not currently usable and is reserved for future usage.

4.2.4. int-i National Identifier Type

This base type allows to define national identifiers. It is made up of two sub-fields:

- an ISO 3166-1 Alpha 3 country code, denoting the country that assigned the identifier;
- the identifier itself (a free-format string), which represents the identifier as defined by the national guidelines.

Here is an example of such a national identifier:

```
<int-i:NationalPersonIdentifier>  
  <int-i:LocationCountryISO3166Alpha3Code>DEU</int-i:LocationCountryISO3166Alpha3Code>  
  <nc:IdentificationID>1234567890</nc:IdentificationID>  
</int-i:NationalPersonIdentifier>
```

5. File Description

5.1. File Content

The maximal number present of each record depends on the type of transaction and the limits set by this standard. An overview is given in the following table:

Table 5.1.: File content per TOT

	CPS	ATP	MPS	NPS	SRE	ERR
Transaction Information Record (Type 1)	1	1	1	1	1	1
User-defined Descriptive Text Record (Type 2)	1	1	1	1	1	1
Minutiae Data Record (T9)	0	0	0 — 1	0	0	0
Face, other body part, or SMT Image Record (Type 10)	0 — 4*	0 — 4*	0	0 — 4*	0 — 4*	0
Friction-ridge Latent Image Record (Type 13)	0	0	1	0	0	0
Variable Resolution Fingerprint Image Record (Type 14)	1 — 14	1 — 14	0	1 — 14	0 — 14	0
Variable Resolution Palmprint Image Record (Type 15)	0 — 8	0 — 8	0	0 — 8	0 — 8	0
Source Representation Record (Type 20)	0	0	0 — 1	0	0	0

For the transmission of the data of one person, one single file is used. In INTERPOL implementation, it is not possible to send multiple persons (Type 2) in one single file, even if the ANSI/NIST standard would allow it.

For the transmission of a criminal case, only one latent image (and one source representation) is allowed to be transmitted in single file. If several latent images (Type 13) need to be sent, as many NIST files have to be created. In INTERPOL implementation, this is not possible to send multiple Type 13 and multiple Type 20, even if the ANSI/NIST standard allows it.

If the receiving system cannot handle multiple Type 10 images, then it should be made clear beforehand so that the senders can limit to one Type 10 (normally the front facial), or the receiving system can process one of the Type 10 (ideally the front pose, but without any guarantee) and silently drop the other ones.

*this type of record supports face only

5.2. Implementation Domains

As the standard allows more than the transmission of fingerprint data (i.e. also DNA), the extension of the standard has to be monitored by one single unit to assure the unity of the doctrine of this document. The IAEWG is the contact point for other working groups or member states for any issue concerning the INTERPOL Implementation.

For the sake of completeness, it is stated that this version of the INTERPOL Implementation has one exception. On grounds of importance and priority, the standard already comprises the possibility to transmit facial images only.

6. Record Description

6.1. Logical Record Types

A transaction is comprised of records. Each Record Type is defined in this standard. The following records are used in the present standard:

Table 6.1.: Logical Record Types

Record Type Identifier	Record Contents	XML-Tag
1	Transaction information record	<itl:PackageInformationRecord>
2	User-defined descriptive text record	<itl:PackageDescriptiveTextRecord>
9	Minutiae data record	<itl:PackageMinutiaeRecord>
10	Face, other body part, or SMT image record	<itl:PackageFacialAndSMTImageRecord>
13	Variable-resolution latent friction ridge image record	<itl:PackageLatentImageRecord>
14	Variable-resolution fingerprint image record	<itl:PackageFingerprintImageRecord>
15	Variable-resolution palmprint image record	<itl:PackagePalmprintImageRecord>
20	Source representation record	<itl:PackageSourceRepresentationRecord>

6.2. Transaction Information Record (aka Type 1)

This record contains routing information and information describing the structure of the rest of the file. This record type also defines the types of transaction and information about its transmission.

It is further described in chapter 8.

6.3. User-defined Descriptive Text Record (aka Type 2)

User-defined descriptive text record shall contain textual elements providing identification and descriptive information associated with the subject of the transaction.

In this context, the subject of the transaction can either be a person, — in this case the User-defined descriptive text conveys information about the person, the circumstances where the fingerprints were acquired. . . —, or a latent — in this case the User-defined descriptive text conveys information about the latent, when and why it was collected. . .

Data contained in this record shall conform in format and content to the specifications of the domain name as listed in Domain Name field (DOM) found in the Transaction information record.

It is further described in chapter 9.

6.4. Minutiae Data Record (aka Type 9)

Minutiae data record shall contain and be used to exchange minutiae or other friction ridge feature data. Each record shall represent the processed (automated and/or manual) image data from which the characteristics are stated. The primary use of this record type shall be for remote searching of latent prints.

It is further described in chapter 10.

6.5. Face, Other Body Part, or SMT Image Record (aka Type 10)

Face, other body part, or SMT image record shall contain and be used to exchange image data from the face, scars, (needle) marks, tattoos (SMT) and other body parts. Textual and analytic information pertinent to the digitized image is also contained in this record type. Quality of the image is of the upmost importance for use with INTERPOL's facial recognition system.

At this time, the present standard allows the transmission of facial images (up to 4) only in this record.

It is further described in chapter 11.

6.6. Variable-Resolution Latent Image Record (aka Type 13)

Variable-resolution latent image record shall contain and be used to exchange latent friction ridge image data (fingerprint, palm print) together with fixed and user defined textual information fields pertinent to the digitized image.

The transmitted image should be cropped to represent the area of a friction ridge of a single finger or palm (i.e. not finger sequences or have extraneous background detail).

The preferred scanning resolution for latent images is 39.37 ppm (1000 ppi), but 19.68ppmm (500dpi) is still supported. The variable resolution latent image data contained in this record shall be preferably either uncompressed or may be the output from a lossless compression algorithm. Lossy compression algorithms are still supported but not recommended.

It is further described in chapter 12.

6.7. Variable-Resolution Fingerprint Image Record (aka Type 14)

Variable-resolution fingerprint image records shall contain fingerprint image data. Fixed and user-defined textual information fields pertinent to the digitized image may also be included.

It is strongly recommended that the resolution for fingerprint images be 39.37 ppm (1000 ppi). It should be noted that as the resolution is increased, more detailed ridge and structure information becomes available in the fingerprint image. However, in all cases the resolution shall be at least 19.69 ppm (500 ppi). The variable-resolution fingerprint image data contained in this record shall be in a compressed form (wsq for 500 ppi, jp2k for 1000 ppi).

The minimum size of the images is dependent of the Fingerprint Acquisition Profile. Please refer to section 13.33 for details.

The ANSI/NIST standard also defines a maximum practical size for the images. For convenience, this maximum size is repeated in the following table:

Table 6.2.: Practical Maximum Dimensions for Fingerprint Images

Finger position	Finger code	Max width (mm)	Max height (mm)	Max width (in)	Max height (in)
Unknown finger	0	40.6	38.1	1.6	1.5
Right thumb	1	40.6	38.1	1.6	1.5
Right index finger	2	40.6	38.1	1.6	1.5
Right middle finger	3	40.6	38.1	1.6	1.5
Right ring finger	4	40.6	38.1	1.6	1.5
Right little finger	5	40.6	38.1	1.6	1.5
Left thumb	6	40.6	38.1	1.6	1.5
Left index finger	7	40.6	38.1	1.6	1.5
Left middle finger	8	40.6	38.1	1.6	1.5
Left ring finger	9	40.6	38.1	1.6	1.5
Left little finger	10	40.6	38.1	1.6	1.5
Plain right thumb	11	25.4	76.2	1	3
Plain left thumb	12	25.4	76.2	1	3
Plain right four fingers	13	81.3	76.2	3.2	3
Plain left four fingers	14	81.3	76.2	3.2	3

It is further described in chapter 13.

6.8. Variable-Resolution Palm Print Image Record (aka Type 15)

Variable-resolution palm print image records shall contain and be used to exchange palm print image data together with fixed and user-defined textual information fields pertinent to the digitized image. It is strongly recommended that the resolution for palm print images be 39.37 ppm (1000 ppi). It should be noted that as the resolution is increased, more detailed ridge and structure information becomes available in the image. However, in all cases the resolution shall be at least 19.69 ppm (500 ppi). The variable-resolution palm print image data contained in this record shall be in a compressed form (wsq for 500 ppi, jp2k for 1000 ppi).

The minimum size of the images is dependent of the Palmprint Acquisition Profile. Please refer to section 14.26 for details.

The ANSI/NIST standard also defines a maximum practical size for the images. For convenience, this maximum size is repeated in the following table:

Table 6.3.: Practical Maximum Dimensions for Palmprint Images

Palm position	Palm code	Max width (mm)	Max height (mm)	Max width (in)	Max height (in)
Unknown palm	20	139.7	213.0	5.5	8.5
Right full palm	21	139.7	213.0	5.5	8.5
Right writer's palm	22	44.5	127.0	1.8	5.0
Left full palm	23	139.7	213.0	5.5	8.5
Left writer's palm	24	44.5	127.0	1.8	5.0
Right lower palm	25	139.7	139.7	5.5	5.5
Right upper palm	26	139.7	139.7	5.5	5.5
Left lower palm	27	139.7	139.7	5.5	5.5
Left upper palm	28	139.7	139.7	5.5	5.5

It is further described in chapter 14.

6.9. Source Representation Record (aka Type 20)

Source representation record is designed for the exchange of images (e.g. lift showing several latents). This record shall contain and be used to exchange image data together with textual information elements pertinent to the digitized image. An extract from this image would typically form the latent image record (Type 13).

The preferred scanning resolution for source representation images is 39.37 ppm (1000 ppi), but 19.68ppmm (500dpi) is also supported. The image data contained in this record shall be preferably either uncompressed or may be the output from a lossless compression algorithm. Lossy compression algorithms are supported but not recommended.

Images of lift should include a scale bar in the image.

It is further described in chapter 15.

7. Implementation Guidelines

7.1. Validating XML against INT-I Schemas

An XML file can be validated against the provided XSD using free open-source tool XMLLint, part of Libxml2 (<http://xmlsoft.org/>).

To do so, the following command must be run:

```
user@host:~/INT-I$ xmllint --schema XMLschemas/int-i/1.0/int-i.xsd --noout XMLsamples/SampleAll-FieldsINT-ITransaction.xml
XMLsamples/SampleAll-FieldsINT-ITransaction.xml validates
```

Should an error occur, the following output will be obtained:

```
user@host:~/INT-I$ xmllint --schema XMLschemas/int-i/1.0/int-i.xsd --noout XMLsamples/SampleAll-FieldsINT-ITransaction.xml
XMLsamples/SampleAll-FieldsINT-ITransaction.xml:146: element Date: Schemas validity error : Element '{http://niem.gov/niem/niem-core/2.0}Date': '' is not a valid value of the atomic type 'xs:date'.
XMLsamples/SampleAll-FieldsINT-ITransaction.xml:147: element DateTime: Schemas validity error : Element '{http://niem.gov/niem/niem-core/2.0}DateTime': This element is not expected.
XMLsamples/SampleAll-FieldsINT-ITransaction.xml fails to validate
```

Note that xmllint command performs the validation against the local XSD delivered as a part of the INTERPOL's [Information Exchange Package Description \(IEPD\)](#) even if the error messages seem to refer to their online counterparts.

7.2. Main Differences with the Previous INTERPOL Implementations

This section highlights the main differences between this new implementation and the previous one.

The legacy tagged record format is no longer supported in this version of the implementation. XML format only is anticipated. The prevalence of XML as an exchange format between IT systems and associated tool sets makes the use of XML much easier to implement and support over the legacy tagged formats.

Type 2 The Type 2 has been simplified and fields that were never actually used have been removed.

In the previous version, it was possible to use the fields above 2.200 for national requirements. In this version, this can be done under a specific XPath (see [2/UDF:X2](#)).

Type 4 vs Type 14 In this version of the implementation, the Type 4 has been replaced by Type 14 to transmit the fingerprints. Type 4 records are not supported anymore.

Missing fingers In the previous version of the implementation, the information regarding the missing fingers (amputated, bandaged, or damaged) was found in the Type 2, with one field (field 2.083) grouping the information for all the missing fingers.

This is no longer the case. This information is now found in the Type 14. See the [Type 14 Description](#) for the details, in particular [field 14/AMP and following fields](#).

The palms are managed in the same way: the information is found in the Type 15. See the [Type 15 Description](#) for the details, in particular [field 15/AMP and following fields](#).

TOT In the previous version, many different Types Of Transaction were defined. Some of them were seldomly used. In this version, the TOT have limited to the most commonly used. This also means that the file types allowed in each TOT have been adjusted. See [File Content](#) for details.

7.3. Limitations

This section gives a list of the limitations of INTERPOL's implementation.

These limitations have been decided to keep the implementation as simple as possible.

NIEM 3.1 and NIEM 4.0 are not supported INTERPOL's implementation only support NIEM 2.1: at the time of the writing of this document, only NIEM 2.1 and NIEM 3.1 were supported by ANSI/NIST umbrella standard and NIEM 3.1 was lacking some essential type (namely the ISO 3166-1 Alpha 3 country codes). The support of NIEM 4.0 in the umbrella standard came too late to be integrated into this version of INTERPOL's implementation. The integration of NIEM 4.0 will be studied later.

Multiple Type 2 records are not supported Even though the ANSI/NIST standard supports transmitting multiple Type 2 in a single file, this is not allowed in INTERPOL's implementation.

Type 9 does not support legacy format minutiae and ULW annotations Even though the ANSI/NIST standard supports transmitting legacy format minutiae and Universal Latent Workstation annotations, this is not allowed in INTERPOL's implementation.

INCITS and EFS in Type 9 INTERPOL's implementation supports both INCITS-378 and EFS for the minutiae format. It is acceptable to use either format or both at the same time. The standard does not dictate any particular behaviour for the receiving system if both formats are present: the receiving system might utilise only one format of the two.

Type 10 records support facial images only Even though the ANSI/NIST standard supports transmission of various types of images in Type 10 (such as [Scars, Marks and Tattoos \(SMT\)](#)), this is not allowed in INTERPOL's implementation which only support facial images (up to 4 images in a single NIST file).

Multiple Type 13 records are not supported Even though the ANSI/NIST standard supports transmitting multiple Type 13 in a single file, this is not allowed in INTERPOL's implementation.

Type 14 records only support 1000dpi or 500dpi Even though the ANSI/NIST standard supports transmitting images of any resolution in Type 14, INTERPOL's implementation only allows 1000dpi and 500dpi.

Segmentation information transmission in Type 14 the umbrella standard allows to transmit the segmentation information for multiple-finger images (see [13.20](#) and [13.26](#)). INTERPOL's implementation does also but with the following limitations:

- there is no guaranty that the receiving system will use the segmentation information;
- if there is no rolled fingers in this acquisition (for instance a slap-only civil application), the segmented individual finger images must be transmitted in their own Type 14 containers;
- INTERPOL's implementation only support rectangle segmentation boxes, not arbitrary polygons.

Note that the segmentation information on the slaps images is never mandatory and the receiving system always has the possibility to recalculate the segmentation.

Multiple Type 20 records are not supported Even though the ANSI/NIST standard supports transmitting multiple Type 20 records in a single file, this is not allowed in INTERPOL's implementation. This also means that there is no need to specify a reference to a specific Type 20 record in Type 9 and Type 13 records.

Given the implementation limitations on Type 9 and Type 13, it is implied that if the Type 20 image contains multiple latents, you still need to send multiple files, one per latent.

Only one candidate per SRE is allowed To respond to a CPS or MPS transaction, INTERPOL's implementation imposes to have one SRE response per candidate. In case of multi-hit, multiple SRE NIST files must be sent.

Namespace prefixes should not be changed For clarity, the namespace prefixes should not be changed in the XML. That is to say that *int-i* should be used for *int-i.xsd*, *biom* for */subset/niem/domains/1.0/biometrics.xsd*, *nc* for */subset/niem/niem-core/2.0/niem-core.xsd*, etc. . . Using generic prefix such as *ns1*, *ns2*, . . . is discouraged and may not be correctly interpreted by the receiving AFIS.

Major Cases and 2-thumb images are not supported Major cases images (also known as EJI, Entire Joint Images: images that include substantive portion of the medial or proximal segments of a finger, or the extreme tip of a fingerprint) are not supported by INTERPOL's implementation. Unsegmented 2-thumb images are not supported either: images of the plain thumbs must be sent segmented, each finger in its own Type 14 file.

XSD are a superset of what is needed to validate INT-I implementation The delivered XSD schemas define more types than strictly needed for INTERPOL's implementation. For instance, the XSD define plantar positions, major cases images. . . , which are not allowed in INTERPOL's implementation. The implementers should follow strictly what is described in this document and only use the documented types.

Some constraints described in the document are not enforced by the XSD Some constraints described in the [Machine-readable Table \(MRT\)](#) are not enforced by the XSD schemas to remain as compliant as possible with the umbrella standard. In such a case, the description of the field will clearly mention that limitation.

7.4. How to read the field description pages?

The following chapters of this document is mostly composed of the description of each field of each record, one page per field. Each page is presented with the same layout, which is detailed in figure 7.1. The information found on those pages comes all from the [MRT](#).

0.1 Criminal Reference Number (XML) - CRN

A

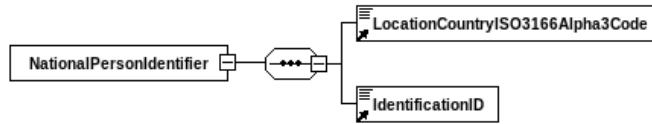

B

Field Reference: 2/CRN:X
 Content Type: Set_X
 XML Tag Name: NationalPersonIdentifier
 Data Type:
 Minimum Length:
 Minimum Occurrences: 0
 Value range: *n/a*
 Code table: *n/a*
 Base type: int-i:NationalIdentifierType

Field ID: [02.010-A_02.010-B]
 Condition: Dependent (see table)
 Defined in: xsd/int-i/1.0/int-i.xsd
 Special Characters: *n/a*
 Maximum Length:
 Maximum Occurrences: 1
 Regular Expression: *n/a*
 Namespace: http://interpol.int/int-i/1.0

C

Dependency table

Type of dependency	Value
Mandatory on Absence of other Field	[2/ORN:X]
Mandatory on Value of other Field, optional otherwise.	[1/TOT]="CPS" [1/TOT]="NPS" [1/TOT]="ATP" [1/TOT]="SRE" and [2/RLS/SRC]="I" and [2/RLS/CAC]="CPS"

D

XPath

```
/itl:PackageDescriptiveTextRecord
├─ /itl:UserDefinedDescriptiveDetail
│   └─ /itl:DomainDefinedDescriptiveDetail
│       └─ /int-i:RecordMetadata
│           └─ /int-i:MiscellaneousIdentification
│               └─ /int-i:NationalPersonIdentifier
```

E

Summary

The Person Identifier (CRN) is a mandatory reference (if ORN is absent) and would be expected in any Person transaction. It should be unique within the country creating the reference and static (i.e. unchanging) for the person the biometrics relate to. It is traditionally an identity level reference rather than an event level reference and would be the primary key into all related information on the person within the country.

It is made up of 2 subfields: a ISO3166 Alpha-3 country code identifying the country owning the Person, and the reference number itself.

F

Valid Examples

```
<int-i:NationalPersonIdentifier>
  <int-i:LocationCountryISO3166Alpha3Code>DEU</int-i:LocationCountryISO3166Alpha3Code>
  <nc:IdentificationID>1234567890</nc:IdentificationID>
</int-i:NationalPersonIdentifier>
```

Figure 7.1.: Example of a field description page

in Zone A of the page, a graphical representation of the XML structure of the field is displayed. If the field is a Set_X type, the schema also displays the children of the field, allowing to see how the XML tree is layed out;

in Zone B of the page, various information regarding the type, presence, format... of the field are given;

Field Reference is XML name of the field;

Field Id is the name of the corresponding field in the traditional NIST format;

Content Type is the type of field:

- Set and Set_X mean the field is an enclosing structure with sub-fields;
- Data, Data_X and all other Data_* mean the field is a terminal field;

Condition is the rules governing the presence of the field. It can takes the following values:

Mandatory the field must be present;

Optional the field can be absent;

Dependent the presence of the field is governed by conditions depending on the value/presence/absence of other(s) field(s). These conditions are clarified in Zone C;

Mandatory within a field the field must be present if the enclosing field is present, but the enclosing field might not be mandatory itself;

Optional within a field the field can be absent, even if the enclosing field itself might be mandatory;

XMLTagName is the name of the tag in the XML file;

Defined in gives the name of the XSD file where the field is defined;

Data Type gives an overview of the type of data. It can take the following values:

Type A , alphabetic: 26 English letters, both upper and lower case, or spaces;

Type N , numeric: 0, 1, 2, 3, 4, 5, 6, 7, 8, 9;

Type AN , alphanumeric: alphabetic and numeric;

Type S , special: used in combination with A, N, or AN representation to indicate Special Characters. The specific characters permitted are listed in Special characters;

Type B or Base64 , base-64 encoded content;

Type H , hexadecimal: 0,1,2,3,4,5,6,7,8,9,A,B,C,D,E,F;

Type U , unicode characters;

Type Y , boolean: true/false or 0/1;

Special Characters gives the list of the permitted special characters when the the field's Data Type is AS, NS, or ANS;

Minimum Length and Maximum Length is the maximum and minimum length of the Data fields;

Minimum occurrences and Maximum occurrences denote the number of times a field or a set can be repeated;

Value range limits the number of values a field can take. It can either define a discrete list of values (for instance "I", "N"), a range of values (for instance 0..99 meaning any integer from 0 included to 99 included) or a mix of the 2 (for instance 0..3,8,20..29);

Regular expression is the regular expression the data must validate;

Code table points to the list of valid codes for this field;

Base type is the type of the fields, as defined in the XSD files;

Namespace is the namespace where the type is defined.

in Zone C of the page, a dependency table is displayed when the field presence condition is "Dependent". This table lists the different rules that govern the presence or absence of the field.

Each row of the table represents a different condition; all the conditions (all the rows) must be validated. Inside a row, the left column describes the type of rule ("Mandatory is another field is present", "Mandatory if another field has a certain value"...), the right column clarifies the field(s) that the rule of the left column is referring to. Multiple lines in the right column can be viewed as independent condition (line 1 or line 2 or line 3).

For instance, in the example show in figure 7.1, the table is read as:

```
[2/CRN] field is mandatory when
  [2/ORN] is absent
and
[2/CRN] field is mandatory when
  [1/TOT] value is CPS
  or
  [1/TOT] value is NPS
  or
  [1/TOT] value is ATP
  or
  [1/TOT] value is SRE and [2/RLS/SRC] value is I and [2/RLS/CAC] value is CPS
```

in Zone D of the page, a representation of the XPath of the field is given. Some fields may be found at different XPath, in this case, all the possible XPath are displayed;

in Zone E of the page, a summary gives information about the field (mainly its purpose). Additional notes and technical notes are also displayed for certain fields, giving extra information (for instance, divergence between the ANSI-NIST umbrella standard and the INTERPOL implementation);

in Zone F of the page, valid examples (and for some fields invalid examples) are given.

7.5. INTERPOL AFIS Gateway

The current version of the AFIS Gateway does not support yet the XML implementation.

The modification of the AFIS Gateway to support this standard is not planned yet. When this is done, the AFIS Gateway should follow this standard exactly.

7. Implementation Guidelines

Also, this standard only describes the content of the NIST file, and not how it is exchanged (via mail, web services,...). This aspects will be covered in the documentation specific to the AFIS Gateway.

8. Transaction Information Record (aka Type 1)

This chapter describes all the fields that can be used in the Transaction Information Record. It first gives detailed information regarding each field, then gives an overview which focuses on the mandatoriness of each field.

8.1. Package Information Record (XML)

Field Reference: 1	Field ID: [01]
Content Type: Set_X	Condition: Mandatory
XML Tag Name: PackageInformationRecord	Defined in: xsd/itl/2011/ITL-2007f-Package.xsd
Data Type:	Special Characters: n/a
Minimum Length:	Maximum Length:
Minimum Occurrences: 1	Maximum Occurrences: 1
Value range: n/a	Regular Expression: n/a
Code table: n/a	
Base type: itl:PackageInformationRecordType	Namespace: http://biometrics.nist.gov/standard/2011

XPath

/itl:PackageInformationRecord

Summary

Information describing transaction.

8. Transaction Information Record (aka Type 1)

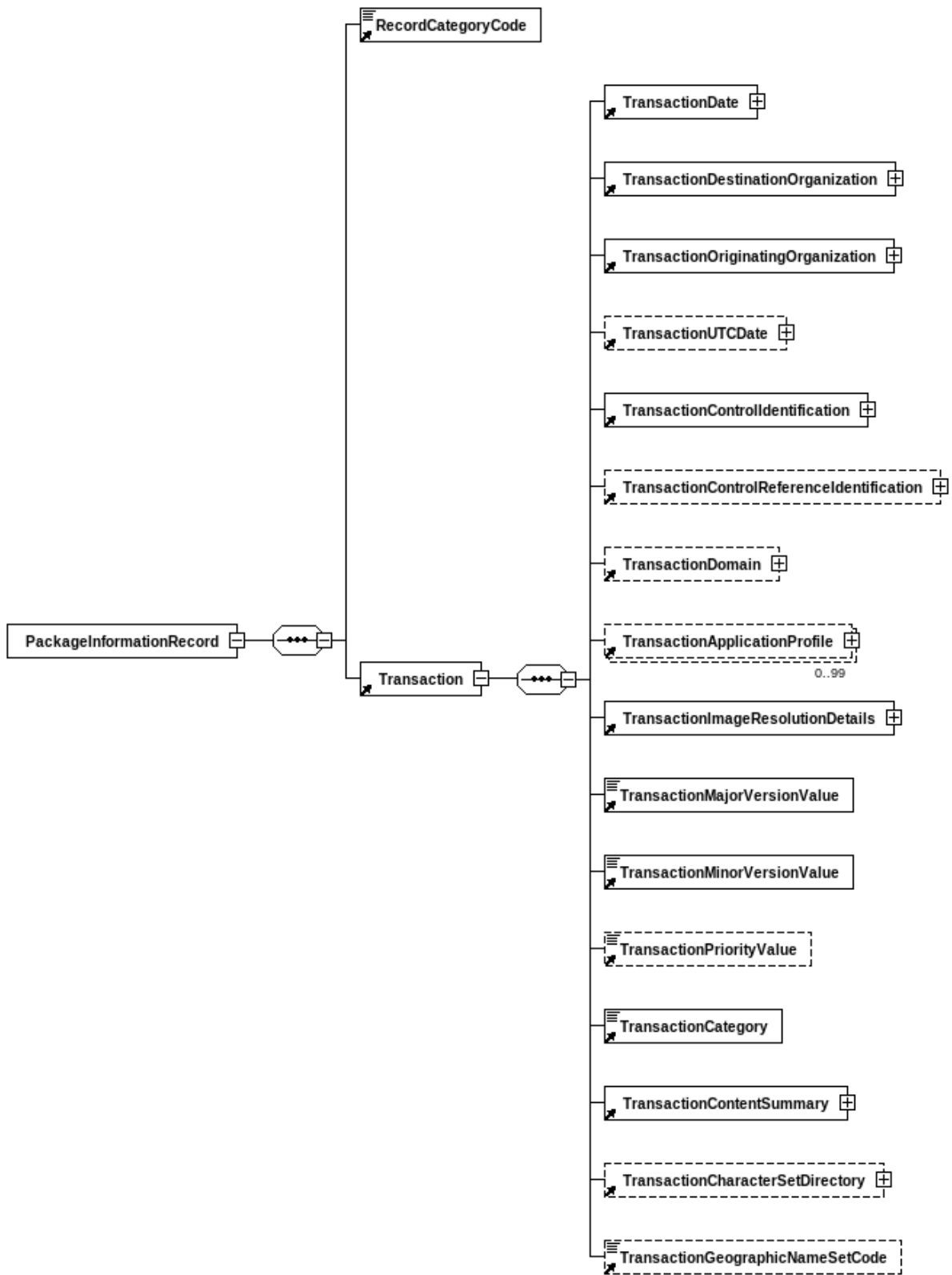

8.2. XML Record Category Code - XRCC

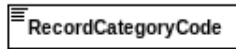

Field Reference: 1/XRCC:X
Content Type: Data_X
XML Tag Name: RecordCategoryCode
Data Type: N
Minimum Length: 1
Minimum Occurrences: 1
Value range: {1}
Code table: *n/a*
Base type: biom:RecordCategoryCodeType

Field ID: [01.001:X]
Condition: Mandatory
Defined in: xsd/niem/biometrics/1.0/biometrics.xsd
Special Characters: *n/a*
Maximum Length: 2
Maximum Occurrences: 1
Regular Expression: *n/a*
Namespace: <http://niem.gov/niem/biometrics/1.0>

XPath

```
/it1:PackageInformationRecord  
  ↘/biom:RecordCategoryCode
```

Summary

Numeric representation of Record Type that the associated block of XML elements represent within the overall transaction, for example 1 for Type-1 Record Type, 14 for Type-14 Record Type. The Record Types are defined within the ANSI-NIST standard.

Valid Examples

```
<biom:RecordCategoryCode>1</biom:RecordCategoryCode>
```

Invalid Examples

```
<biom:RecordCategoryCode>01</biom:RecordCategoryCode>
```

8.3. Transaction (XML)

Field Reference: 1/VER_1/ANM
Content Type: Set_X
XML Tag Name: Transaction
Data Type:
Minimum Length:
Minimum Occurrences: 1
Value range: *n/a*
Code table: *n/a*
Base type: biom:TransactionType

Field ID: [01.002_01.017]
Condition: Mandatory
Defined in: xsd/niem/biometrics/1.0/biometrics.xsd
Special Characters: *n/a*
Maximum Length:
Maximum Occurrences: 1
Regular Expression: *n/a*
Namespace: <http://niem.gov/niem/biometrics/1.0>

XPath

```
/it1:PackageInformationRecord  
  ↘/biom:Transaction
```

Summary

This is the parent XML tag for detailed transaction information traditionally grouped in a Type 1 logical record.

Notes

Applies to 1.002, 1.003, 1.004, 1.005, 1.006, 1.007, 1.008, 1.009, 1.010, 1.011, 1.012, 1.013, 1.014, 1.015, 1.016, and 1.017.

8. Transaction Information Record (aka Type 1)

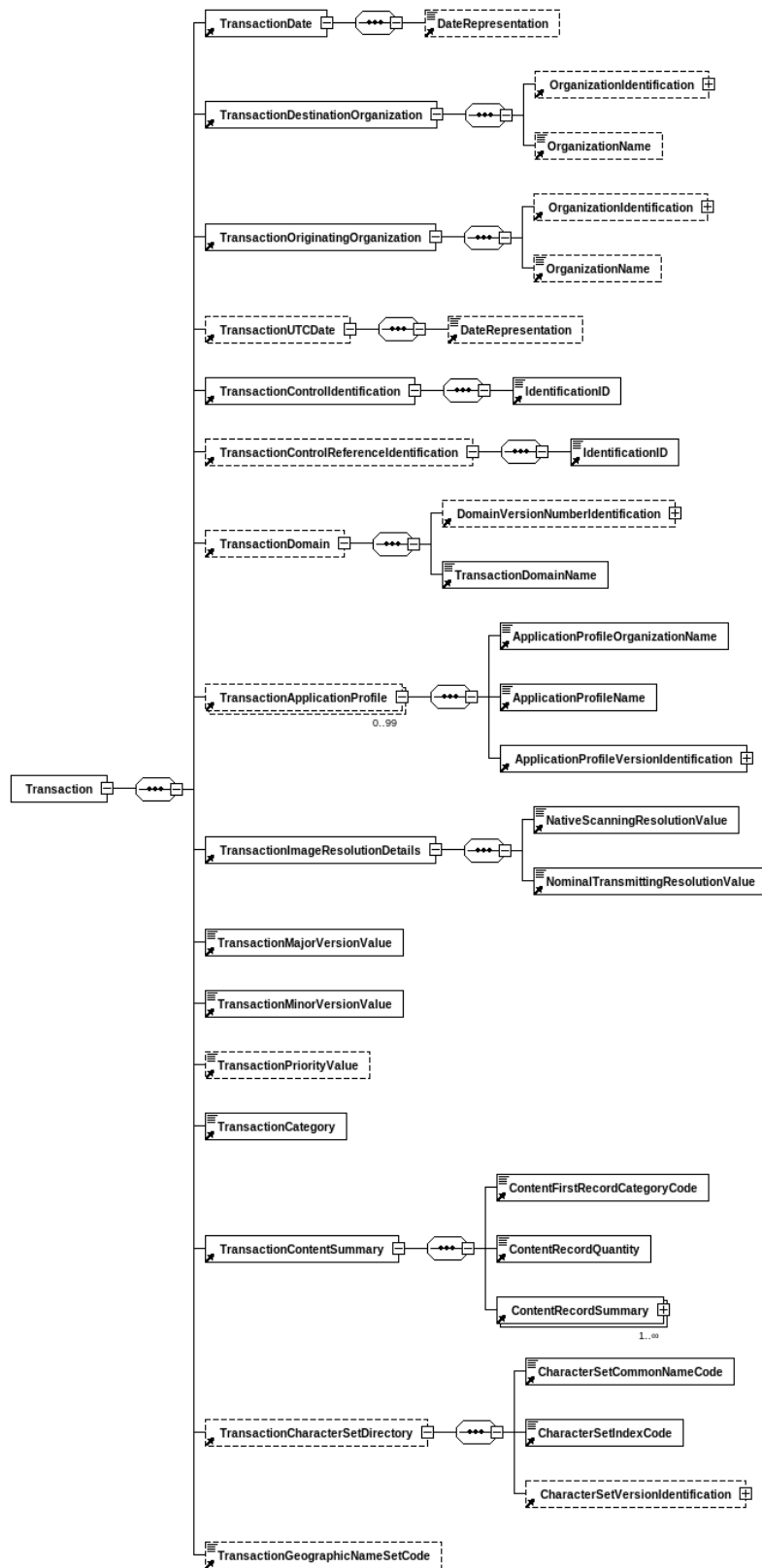

8.4. Major Version - VER

TransactionMajorVersionValue

Field Reference: 1/VER:X1
Content Type: Data_NX-1T
XML Tag Name: TransactionMajorVersionValue
Data Type: N
Minimum Length: 2
Minimum Occurrences: 1
Value range: {05}
Code table: *n/a*
Base type: niem-xsd:nonNegativeInteger

Field ID: [01.002:X1]
Condition: Mandatory
Defined in: xsd/niem/biometrics/1.0/biometrics.xsd
Special Characters: *n/a*
Maximum Length: 2
Maximum Occurrences: 1
Regular Expression: *n/a*

Namespace: <http://niem.gov/niem/biometrics/1.0>

XPath

```

/itl:PackageInformationRecord
  ↙/biom:Transaction
    ↙/biom:TransactionMajorVersionValue
  
```

Summary

A current major version number of the ANSI/NIST-ITL standard implemented by the software or system creating the file.

Notes

This element contains the major version number of the ANSI/NIST umbrella standard on which INTERPOL implementation is based. It must be set to “05” (which represents the 2011 ANSI NIST version and the 2013 and 2015 Updates).

Valid Examples

```
<biom:TransactionMajorVersionValue>05<biom:TransactionMajorVersionValue>
```

8.5. Minor Version - VER

TransactionMinorVersionValue

Field Reference: 1/VER:X2
Content Type: Data_NX-1T
XML Tag Name: TransactionMinorVersionValue
Data Type: N
Minimum Length: 2
Minimum Occurrences: 1
Value range: {02}
Code table: *n/a*
Base type: niem-xsd:nonNegativeInteger

Field ID: [01.002:X2]
Condition: Mandatory
Defined in: xsd/niem/biometrics/1.0/biometrics.xsd
Special Characters: *n/a*
Maximum Length: 2
Maximum Occurrences: 1
Regular Expression: *n/a*
Namespace: <http://niem.gov/niem/biometrics/1.0>

XPath

```

/itl:PackageInformationRecord
  ↳/biom:Transaction
    ↳/biom:TransactionMinorVersionValue
  
```

Summary

A current minor version number of the ANSI/NIST-ITL standard implemented by the software or system creating the file.

Notes

This element contains the minor version number of the ANSI/NIST umbrella standard on which INTERPOL implementation is based. It must be set to “02” (which represents the 2015 Update of ANSI/NIST).

Valid Examples

```
<biom:TransactionMinorVersionValue>02</biom:TransactionMinorVersionValue>
```

8.6. Transaction Content (XML) - CNT

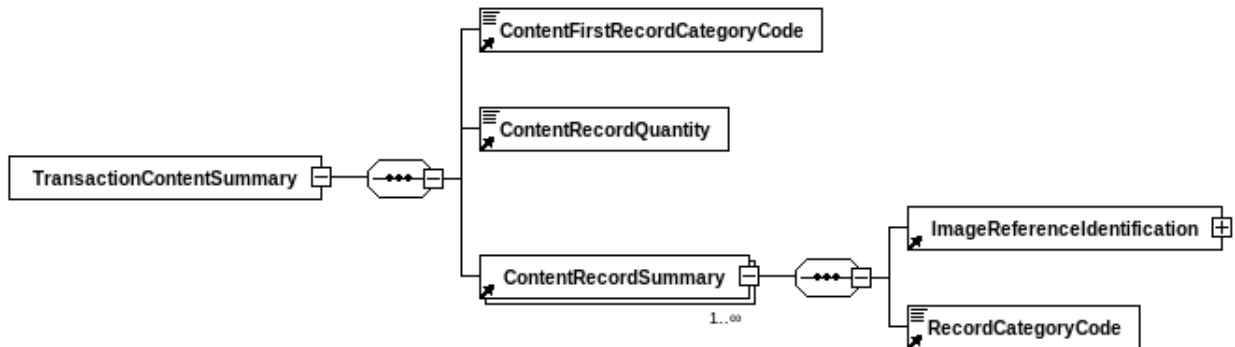

Field Reference: 1/CNT:X
Content Type: Set_X
XML Tag Name: TransactionContentSummary
Data Type:
Minimum Length:
Minimum Occurrences: 1
Value range: *n/a*
Code table: *n/a*
Base type: biom:TransactionContentSummaryType

Field ID: [01.003:X]
Condition: Mandatory
Defined in: xsd/niem/biometrics/1.0/biometrics.xsd
Special Characters: *n/a*
Maximum Length:
Maximum Occurrences: 1
Regular Expression: *n/a*
Namespace: <http://niem.gov/niem/biometrics/1.0>

XPath

```

/itl:PackageInformationRecord
  ↳/biom:Transaction
    ↳/biom:TransactionContentSummary
  
```

Summary

These elements provide a summary and packing list of the record contents being transmitted within the transaction.

Valid Examples

```

<biom:TransactionContentSummary>
  <biom:ContentFirstRecordCategoryCode>1</biom:ContentFirstRecordCategoryCode>
  <biom:ContentRecordQuantity>00</biom:ContentRecordQuantity>
  <biom:ContentRecordSummary>
    <biom:ImageReferenceIdentification>
      <nc:IdentificationID>0</nc:IdentificationID>
    </biom:ImageReferenceIdentification>
    <biom:RecordCategoryCode>2</biom:RecordCategoryCode>
  </biom:ContentRecordSummary>
</biom:TransactionContentSummary>
  
```

8.7. First Record Category Code - FRC

 ContentFirstRecordCategoryCode
--

Field Reference: 1/CNT/FRC
Content Type: Data
XML Tag Name: ContentFirstRecordCategoryCode
Data Type: N
Minimum Length: 1
Minimum Occurrences: 1
Value range: {1}
Code table: see table [A.52](#)
Base type: biom:FirstRecordCategoryCodeType

Field ID: [01.003-A]
Condition: Mandatory within a field
Defined in: xsd/niem/biometrics/1.0/biometrics.xsd
Special Characters: *n/a*
Maximum Length: 1
Maximum Occurrences: 1
Regular Expression: *n/a*
Namespace: <http://niem.gov/niem/biometrics/1.0>

Exceptions
see Technical Notes below

XPath

```
/itl:PackageInformationRecord  
  ↳/biom:Transaction  
    ↳/biom:TransactionContentSummary  
      ↳/biom:ContentFirstRecordCategoryCode
```

Summary
Indicates first record is a Type-1 record.

Technical Notes
This information item shall appear once and in the first subfield only.

Valid Examples

<code><biom:ContentFirstCategoryCode>1</biom:ContentFirstCategoryCode></code>

8.8. Content Record Count - CRC

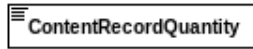

Field Reference: 1/CNT/CRC
Content Type: Data
XML Tag Name: ContentRecordQuantity
Data Type: N
Minimum Length: 1
Minimum Occurrences: 1
Value range: {1..999}
Code table: *n/a*
Base type: niem-xsd:nonNegativeInteger

Field ID: [01.003-B]
Condition: Mandatory within a field
Defined in: xsd/niem/biometrics/1.0/biometrics.xsd
Special Characters: *n/a*
Maximum Length: 3
Maximum Occurrences: 1
Regular Expression: *n/a*

Namespace: <http://niem.gov/niem/biometrics/1.0>

Exceptions

see Technical Notes below

XPath

```
/it1:PackageInformationRecord  
  ↳/biom:Transaction  
    ↳/biom:TransactionContentSummary  
      ↳/biom:ContentRecordQuantity
```

Summary

Sum of Type-2 through to Type-99 records.

Technical Notes

This information item shall appear once and in the first subfield only.

Valid Examples

```
<biom:ContentRecordQuantity>13</biom:ContentRecordQuantity>
```

8.9. Content Record Summary (XML)

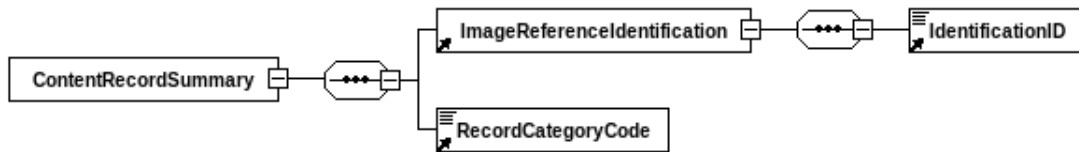

Field Reference: 1/CNT/REC_1/CNT/IDC
Content Type: Set_X
XML Tag Name: ContentRecordSummary
Data Type:
Minimum Length:
Minimum Occurrences: 1
Value range: *n/a*
Code table: *n/a*
Base type: biom:ContentRecordSummaryType

Field ID: [01.003-C_01.003-D]
Condition: Mandatory
Defined in: xsd/niem/biometrics/1.0/biometrics.xsd
Special Characters: *n/a*
Maximum Length:
Maximum Occurrences: *
Regular Expression: *n/a*
Namespace: <http://niem.gov/niem/biometrics/1.0>

XPath

```

/itl:PackageInformationRecord
  ↙/biom:Transaction
    ↙/biom:TransactionContentSummary
      ↙/biom:ContentRecordSummary
  
```

Summary

A summary of the contents of each record in the transaction other than the Type 1 transaction record. There should be an instance of this for every transaction record type other than Type 1. (number of occurrences = number of records in the transaction minus 1).

Notes

Applies to 1.003-C and 1.003-D

Valid Examples

```

<biom:ContentRecordSummary>
  <biom:ImageReferenceIdentification>
    <nc:IdentificationID>0</nc:IdentificationID>
  </biom:ImageReferenceIdentification>
  <biom:RecordCategoryCode>2</biom:RecordCategoryCode>
</biom:ContentRecordSummary>
  
```

8.10. Record Category Code (XML) - REC

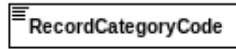

Field Reference: 1/CNT/REC:X
Content Type: Data_X
XML Tag Name: RecordCategoryCode
Data Type: N
Minimum Length: 1
Minimum Occurrences: 1
Value range: {>1}
Code table: see table [A.52](#)
Base type: biom:RecordCategoryCodeType

Field ID: [01.003-C:X]
Condition: Mandatory within a field
Defined in: xsd/niem/biometrics/1.0/biometrics.xsd
Special Characters: *n/a*
Maximum Length: 2
Maximum Occurrences: 1
Regular Expression: *n/a*
Namespace: <http://niem.gov/niem/biometrics/1.0>

XPath

```
/it1:PackageInformationRecord  
  ↳/biom:Transaction  
    ↳/biom:TransactionContentSummary  
      ↳/biom:ContentRecordSummary  
        ↳/biom:RecordCategoryCode
```

Summary

A numeric value describing the kind of record. For example, 2 for Type-2; 14 for Type-14.

Valid Examples

```
<biom:RecordCategoryCode>2</biom:RecordCategoryCode>
```

8.11. Information Designation Character (XML) - IDC

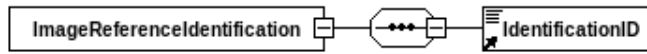

Field Reference: 1/CNT/IDC:X

Content Type: Data_X

XML Tag Name: ImageReferenceIdentification

Data Type: N

Minimum Length: 1

Minimum Occurrences: 1

Value range: {0..99}

Code table: *n/a*

Base type: niem-xsd:string

Field ID: [01.003-D:X]

Condition: Mandatory within a field

Defined in: xsd/niem/biometrics/1.0/biometrics.xsd

Special Characters: *n/a*

Maximum Length: 2

Maximum Occurrences: 1

Regular Expression: *n/a*

Namespace: <http://niem.gov/niem/biometrics/1.0>

XPath

```

/itl:PackageInformationRecord
  ↳/biom:Transaction
    ↳/biom:TransactionContentSummary
      ↳/biom:ContentRecordSummary
        ↳/biom:ImageReferenceIdentification
          ↳/nc:IdentificationID
  
```

Summary

IDC for associated record in 1.003-C.

Notes

Each of the records present in a transaction, with the exception of the Type-1 record, shall include a field (xx.002) containing the corresponding information designation character / IDC.

- Most frequently, IDCs are used to link a particular finger/palm/plantar image (in a Type - 4, 13, 14, 15, 19 records) with the corresponding Type-9 minutiae record.
- In ANSI/NIST umbrella implementation, two or more image records may share a single IDC only when they are enhancements of a single image; such transformations shall have identical dimensions, and shall not be distorted with respect to each other (i.e., a feature at a given position in one image shall be in the same position in the other image).

Such a thing (sharing a single IDC) is not possible in INTERPOL's implementation.

Valid Examples

```

<biom:ImageReferenceIdentification>
  <nc:IdentificationID>0</nc:IdentificationID>
</biom:ImageReferenceIdentification>
  
```

8.12. Type of Transaction - TOT

 TransactionCategoryCode

Field Reference: 1/TOT
Content Type: Data
XML Tag Name: TransactionCategoryCode
Data Type: AS
Minimum Length: 3
Minimum Occurrences: 1
Value range: *n/a*
Code table: see table [A.60](#)
Base type: int-i:TransactionCategoryCodeType

Field ID: [01.004]
Condition: Mandatory
Defined in: xsd/int-i/1.0/int-i.xsd
Special Characters: *n/a*
Maximum Length: 3
Maximum Occurrences: 1
Regular Expression: *n/a*
Namespace: <http://interpol.int/int-i/1.0>

XPath

```
/itl:PackageInformationRecord  
  ↳/biom:Transaction  
    ↳/int-i:TransactionCategoryCode
```

Summary

Type of Transaction (TOT) identifier (in accordance with definitions provided by the domain or application profile).

Valid Examples

<code><int-i:TransactionCategoryCode>ATP</int-i:TransactionCategoryCode></code>

8.13. Date (XML) - DAT



Field Reference: 1/DAT:X

Content Type: Data_X

XML Tag Name: TransactionDate

Data Type: NS

Minimum Length: 10

Minimum Occurrences: 1

Value range: *n/a*

Code table: *n/a*

Base type: [niem-xsd:date](#) or [niem-xsd:dateTime](#)

Field ID: [01.005:X]

Condition: Mandatory

Defined in: [xsd/niem/biometrics/1.0/biometrics.xsd](#)

Special Characters: [-]

Maximum Length: 20

Maximum Occurrences: 1

Regular Expression: $\backslash d\{4\}-\backslash d\{2}-\backslash d\{2}(T\backslash d\{2}:\backslash d\{2}:\backslash d\{2}(Z)\{0,1\})\{0,1\}$

Namespace: <http://niem.gov/niem/biometrics/1.0>

XPath

```
/itl:PackageInformationRecord
  ↳/biom:Transaction
    ↳/biom:TransactionDate
      ↳/nc:Date
```

or

```
/itl:PackageInformationRecord
  ↳/biom:Transaction
    ↳/biom:TransactionDate
      ↳/nc:DateTime
```

Summary

Local date (and time) that the transaction was submitted.

Notes

The date (and time) format should follow the ISO 8601 standard.

Valid Examples

```
<biom:TransactionDate>
  <nc:Date>2007-01-01</nc:Date>
</biom:TransactionDate>
or
<biom:TransactionDate>
  <nc:DateTime>2007-01-01T01:02:03Z</nc:DateTime>
</biom:TransactionDate>
```

Invalid Examples

```
<biom:TransactionDate>  
  <nc:DateTime>2017-07-26T16:48</nc:DateTime>  
</biom:TransactionDate>  
or  
<biom:TransactionDate>  
  <nc:DateTime>2017-07-26T16:48:52+02:00</nc:DateTime>  
</biom:TransactionDate>  
or  
<biom:Transactionate>  
  <nc:DateTime><22017-07-26T16:48:52.023</nc:DateTime>  
</biom:TransactionDate>
```

8.14. Priority - PRY

TransactionPriorityValue

Field Reference: 1/PRY	Field ID: [01.006]
Content Type: Data	Condition: Optional
XML Tag Name: TransactionPriorityValue	Defined in: xsd/niem/biometrics/1.0/biometrics.xsd
Data Type: N	Special Characters: <i>n/a</i>
Minimum Length: 1	Maximum Length: 1
Minimum Occurrences: 0	Maximum Occurrences: 1
Value range: {1..9}	Regular Expression: <i>n/a</i>
Code table: <i>n/a</i>	
Base type: niem-xsd:nonNegativeInteger	Namespace: http://niem.gov/niem/biometrics/1.0

XPath

```
/it1:PackageInformationRecord
  ↙/biom:Transaction
    ↙/biom:TransactionPriorityValue
```

Summary

The urgency with which transaction response is desired.

Notes

Priority is optional element and is used to assign a desired priority for the processing of the relevant transaction. The priority is a numeric value from 1 to 9, with 1 denoting the highest priority. If no priority element is assigned then the receiving systems should use a default priority, as agreed between the parties.

The priority value would be assigned by the initiator of any request transaction. The ideal behaviour is for the receiver of the request transaction to echo the priority field and associated priority value (as assigned in the request) in any associated response transactions (even if the transaction has been processed at a default priority).

Valid Examples

```
<biom:TransactionPriorityValue>1</biom:TransactionPriorityValue>
```

8.15. Transaction Destination Organization (XML)

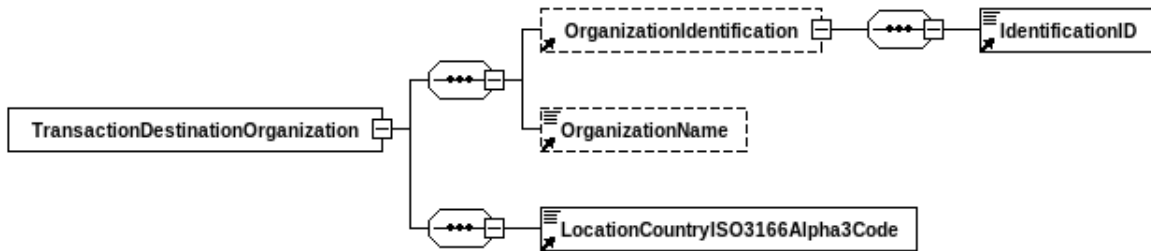

Field Reference: 1/DAI_1/ANM/DAN

Content Type: Set_X

XML Tag Name: TransactionDestinationOrganization

Data Type:

Minimum Length:

Minimum Occurrences: 1

Value range: *n/a*

Code table: *n/a*

Base type: int-i:TransactionOrganizationType

Field ID: [01.007_01.017-C]

Condition: Mandatory

Defined in: xsd/int-i/1.0/int-i.xsd

Special Characters: *n/a*

Maximum Length:

Maximum Occurrences: 1

Regular Expression: *n/a*

Namespace: <http://interpol.int/int-i/1.0>

XPath

```

/itl:PackageInformationRecord
  ↳/biom:Transaction
    ↳/int-i:TransactionDestinationOrganization
  
```

Summary

The administration or organization designated to receive the transmission.

Valid Examples

```

<int-i:TransactionDestinationOrganization>
  <nc:OrganizationName>BKA</nc:OrganizationName>
  <int-i:LocationCountryISO3166Alpha3Code>DEU</int-i:LocationCountryISO3166Alpha3Code>
</int-i:TransactionDestinationOrganization>
  
```

8.16. Destination Agency Identifier - DAI



Field Reference: 1/DAI

Content Type: Data

XML Tag Name: OrganizationIdentification

Data Type: ANS

Minimum Length: 1

Minimum Occurrences: 0

Value range: *n/a*

Code table: *n/a*

Base type: niem-xsd:String

Field ID: [01.007]

Condition: Optional

Defined in: xsd/niem/niem-core/2.0/niem-core.xsd

Special Characters: ALL

Maximum Length: *

Maximum Occurrences: 1

Regular Expression: *n/a*

Namespace: <http://niem.gov/niem/niem-core/2.0>

Exceptions

see Technical Notes below

XPath

```
/itl:PackageInformationRecord
  ↳/biom:Transaction
    ↳/int-i:TransactionDestinationOrganization
      ↳/nc:OrganizationIdentification
        ↳/nc:IdentificationID
```

Summary

An identifier for the administration or organization designated to receive the transmission

Notes

Name of destination agency may be entered in 1.017.

Technical Notes

This element has been kept for compatibility with the ANSI/NIST standard, but it is not used in the INTERPOL implementation. If present, it will be ignored.

8.17. Transaction Originating Organization (XML)

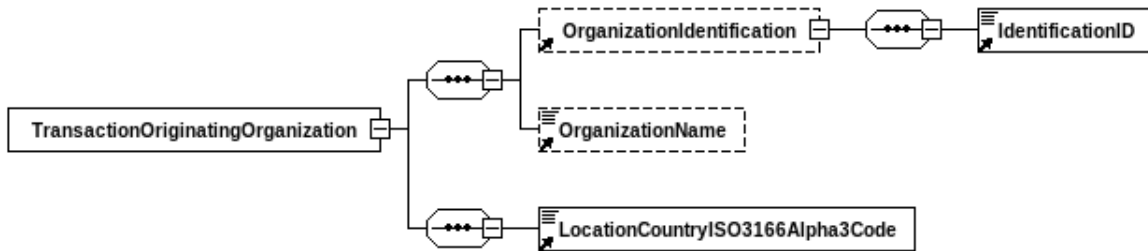

Field Reference: 1/ORI_1/ANM/OAN

Content Type: Set_X

XML Tag Name: TransactionOriginatingOrganization

Data Type:

Minimum Length:

Minimum Occurrences: 1

Value range: *n/a*

Code table: *n/a*

Base type: int-i:TransactionOrganizationType

Field ID: [01.008_01.017-D]

Condition: Mandatory

Defined in: xsd/int-i/1.0/int-i.xsd

Special Characters: *n/a*

Maximum Length:

Maximum Occurrences: 1

Regular Expression: *n/a*

Namespace: <http://interpol.int/int-i/1.0>

XPath

```

/itl:PackageInformationRecord
  ↳/biom:Transaction
    ↳/int-i:TransactionOriginatingOrganization
  
```

Summary

The administration or organization designated to receive the transmission.

Valid Examples

```

<int-i:TransactionOriginatingOrganization>
  <nc:OrganizationName>FAED</nc:OrganizationName>
  <int-i:LocationCountryISO3166Alpha3Code>FRA</int-i:LocationCountryISO3166Alpha3Code>
</int-i:TransactionOriginatingOrganization>
  
```

8.18. Originating Agency Identifier - ORI

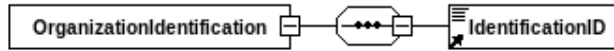

Field Reference: 1/ORI

Content Type: Data

XML Tag Name: OrganizationIdentification

Data Type: ANS

Minimum Length: 1

Minimum Occurrences: 0

Value range: *n/a*

Code table: *n/a*

Base type: niem-xsd:String

Field ID: [01.008]

Condition: Optional

Defined in: xsd/niem/niem-core/2.0/niem-core.xsd

Special Characters: ALL

Maximum Length: *

Maximum Occurrences: 1

Regular Expression: *n/a*

Namespace: <http://niem.gov/niem/niem-core/2.0>

Exceptions

see Technical Notes below

XPath

```
/itl:PackageInformationRecord
  ↳/biom:Transaction
    ↳/int-i:TransactionOriginatingOrganization
      ↳/nc:OrganizationIdentification
        ↳/nc:IdentificationID
```

Summary

An identifier for the administration or organization originating the transmission

Notes

Name of destination agency may be entered in 1.017.

Technical Notes

This element has been kept for compatibility with the ANSI/NIST standard, but it is not used in the INTERPOL implementation. If present, it will be ignored.

8.19. Transaction Control Number - TCN

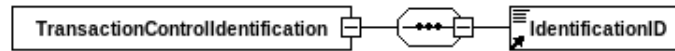

Field Reference: 1/TCN

Content Type: Data

XML Tag Name: TransactionControlIdentification

Data Type: AN

Minimum Length: 15

Minimum Occurrences: 1

Value range: *n/a*

Code table: *n/a*

Base type: niem-xsd:String

Field ID: [01.009]

Condition: Mandatory

Defined in: xsd/niem/biometrics/1.0/biometrics.xsd

Special Characters: *n/a*

Maximum Length: 15

Maximum Occurrences: 1

Regular Expression: `\d{14}[A-HJ-NP-RT-Z]`

Namespace: <http://niem.gov/niem/biometrics/1.0>

Exceptions

see Technical Notes below

XPath

```

/itl:PackageInformationRecord
  ↙/biom:Transaction
    ↙/biom:TransactionControlIdentification
      ↙/nc:IdentificationID
  
```

Summary

Transaction control number as assigned by the originating agency. A unique control number shall be assigned to each transaction. For any transaction that requires a response, the respondent shall refer to this number in communicating with the originating agency.

Notes

This element is a control number for reference purposes. It should be generated by the computer and shall have the following format:

YYSSSSSSSSSSSA

where *YY* is the year of the transaction, *SSSSSSSSSSSS* is an twelve-digit serial number, and *A* is a check character generated by following the procedure given below. Originating agency has to ensure that the TCN is unique and that no other transaction of the agency will have the same TCN.

The number corresponding to the check character is generated using the following formula:

$$checkdigit = (YY \times 10^{12} + SSSSSSSSSSSS) \bmod 23$$

where *YY* and *SSSSSSSSSSSS* are the numerical values of the last two digits of the year and the serial number respectively.

The check character is then generated from this table:

8. Transaction Information Record (aka Type 1)

Check digit	Check character	Check digit	Check character	Check digit	Check character
1	A	9	J	17	T
2	B	10	K	18	U
3	C	11	L	19	V
4	D	12	M	20	W
5	E	13	N	21	X
6	F	14	P	22	Y
7	G	15	Q	0	Z
8	H	16	R		

Technical Notes

The TCN format of the INTERPOL's implementation diverges from the ANSI/NIST standard by not allowing special characters.

Valid Examples

```
<biom:TransactionControlIdentification>  
  <nc:IdentificationID>19125458357684J</nc:IdentificationID>  
</biom:TransactionControlIdentification>
```

Invalid Examples

```
<biom:TransactionControlIdentification>  
  <nc:IdentificationID>11045467866</nc:IdentificationID>  
</biom:TransactionControlIdentification>  
or  
<biom:TransactionControlIdentification>  
  <nc:IdentificationID>19125458357684A</nc:IdentificationID>  
</biom:TransactionControlIdentification>
```

8.20. Transaction Control Reference Number - TCR

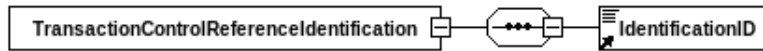

Field Reference: 1/TCR

Content Type: Data

XML Tag Name: TransactionControlReferenceIdentification

Data Type: AN

Minimum Length: 15

Minimum Occurrences: 0

Value range: *n/a*

Code table: *n/a*

Base type: niem-xsd:String

Field ID: [01.010]

Condition: Dependent (see table)

Defined in: xsd/niem/biometrics/1.0/biometrics.xsd

Special Characters: *n/a*

Maximum Length: 15

Maximum Occurrences: 1

Regular Expression: \d{14}[A-HJ-NP-RT-Z]

Namespace: <http://niem.gov/niem/biometrics/1.0>

Dependency table

Type of dependency	Value
Mandatory on Value of other Field, optional otherwise.	[1/TOT]="SRE" [1/TOT]="ERR"

XPath

```
/itl:PackageInformationRecord
  ↳/biom:Transaction
    ↳/biom:TransactionControlReferenceIdentification
      ↳/nc:IdentificationID
```

Summary

TCN of a previously submitted transaction (used for responses only).

Notes

This element shall be used for responses that refer to the TCN of a previous transaction involving an inquiry or other action that required a response. It therefore has the same format as TCN (Field 1.009).

Valid Examples

```
<biom:TransactionControlReferenceIdentification>
  <nc:IdentificationID>19125458357683H</nc:IdentificationID>
</biom:TransactionControlReferenceIdentification>
```

Invalid Examples

```
<biom:TransactionControlIdentification>
  <nc:IdentificationID>11045467866</nc:IdentificationID>
</biom:TransactionControlIdentification>
or
<biom:TransactionControlIdentification>
  <nc:IdentificationID>19125458357684A</nc:IdentificationID>
</biom:TransactionControlIdentification>
```

8.21. Transaction Image Resolution Details (XML)

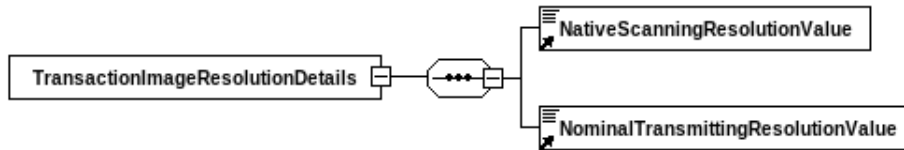

Field Reference: 1/NSR_1/NTR

Content Type: Set_X

XML Tag Name: TransactionImageResolutionDetails

Data Type:

Minimum Length:

Minimum Occurrences: 1

Value range: *n/a*

Code table: *n/a*

Base type: biom:ImageResolutionType

Field ID: [01.011_01.012]

Condition: Mandatory

Defined in: xsd/niem/biometrics/1.0/biometrics.xsd

Special Characters: *n/a*

Maximum Length:

Maximum Occurrences: 1

Regular Expression: *n/a*

Namespace: <http://niem.gov/niem/biometrics/1.0>

XPath

```
/it1:PackageInformationRecord
  ↳/biom:Transaction
    ↳/biom:TransactionImageResolutionDetails
```

Summary

A set of resolution values in pixels per mm for a transaction.

Notes

The image resolution details contain the Native Scanning Resolution (Field 1.011, NSR) and the Nominal Transmitting Resolution (Field 1.012, NTR). The values are set to '00.00'.

Valid Examples

```
<biom:TransactionImageResolutionDetails>
  <biom:NativeScanningResolutionValue>00.00</biom:NativeScanningResolutionValue>
  <biom:NominalTransmittingResolutionValue>00.00</biom:NominalTransmittingResolutionValue>
</biom:TransactionImageResolutionDetails>
```

8.22. Native Scanning Resolution (XML) - NSR

NativeScanningResolutionValue

Field Reference: 1/NSR:X

Content Type: Data_X

XML Tag Name: NativeScanningResolutionValue

Data Type: NS

Minimum Length: 4

Minimum Occurrences: 1

Value range: {00.00}

Code table: *n/a*

Base type: niem-xsd:decimal

Field ID: [01.011:X]

Condition: Mandatory

Defined in: xsd/niem/biometrics/1.0/biometrics.xsd

Special Characters: [,]

Maximum Length: 5

Maximum Occurrences: 1

Regular Expression: \d{1,2}\.\d{2}

Namespace: <http://niem.gov/niem/biometrics/1.0>

Exceptions

see Technical Notes below

XPath

```
/it1:PackageInformationRecord
└─/biom:Transaction
   └─/biom:TransactionImageResolutionDetails
      └─/biom:NativeScanningResolutionValue
```

Summary

A native resolution of transaction originator's scanning equipment.

Technical Notes

Set to "00.00" if there are no Type-4 records in the transaction. This field does not apply to Type-7 records in this version of the standard unless specified as such by the domain or application profile.

Valid Examples

```
<biom:NativeScanningResolutionValue>00.00</biom:NativeScanningResolutionValue>
```

8.23. Nominal Resolution (XML) - NTR

NominalTransmittingResolutionValue

Field Reference: 1/NTR:X

Content Type: Data_X

XML Tag Name: NominalTransmittingResolutionValue

Data Type: NS

Minimum Length: 4

Minimum Occurrences: 1

Value range: {00.00}

Code table: *n/a*

Base type: niem-xsd:decimal

Field ID: [01.012:X]

Condition: Mandatory

Defined in: xsd/niem/biometrics/1.0/biometrics.xsd

Special Characters: [,]

Maximum Length: 5

Maximum Occurrences: 1

Regular Expression: \d{1,2}\.\d{2}

Namespace: <http://niem.gov/niem/biometrics/1.0>

XPath

```
/it1:PackageInformationRecord
  ↳/biom:Transaction
    ↳/biom:TransactionImageResolutionDetails
      ↳/biom:NominalTransmittingResolutionValue
```

Summary

Nominal scanning resolution of image(s) being exchanged.

Valid Examples

```
<biom:NominalTransmittingResolutionValue>00.00</biom:NominalTransmittingResolutionValue>
```

8.24. Domain Name - DOM

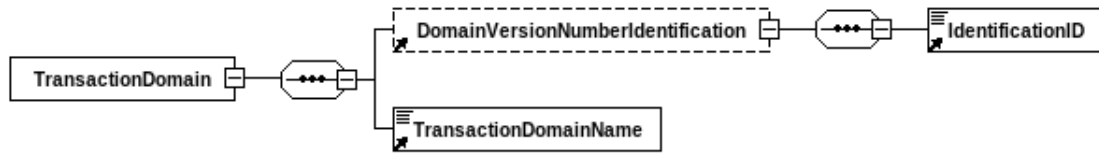

Field Reference: 1/DOM
Content Type: Set
XML Tag Name: TransactionDomain
Data Type:
Minimum Length:
Minimum Occurrences: 1
Value range: *n/a*
Code table: *n/a*
Base type: biom:TransactionDomainType

Field ID: [01.013]
Condition: Mandatory
Defined in: xsd/niem/biometrics/1.0/biometrics.xsd
Special Characters: *n/a*
Maximum Length:
Maximum Occurrences: 1
Regular Expression: *n/a*
Namespace: <http://niem.gov/niem/biometrics/1.0>

XPath

```

/itl:PackageInformationRecord
  ↳/biom:Transaction
    ↳/biom:TransactionDomain
  
```

Summary

Domain name for Type-2 record implementation.

Notes

Even though the XSD declares this field as optional, it must be specified in the INTERPOL implementation.

The domain name is “INT-I”, the domain version number “XXYY” (XX for major revision, YY for minor revision). The domain version represents the current INTERPOL implementation.

The current domain version for this implementation is “0600”.

Valid Examples

```

<biom:TransactionDomain>
  <biom:DomainVersionNumberIdentification>
    <nc:IdentificationID>0600</nc:IdentificationID>
  </biom:DomainVersionNumberIdentification>
  <biom:TransactionDomainName>INT-I</biom:TransactionDomainName>
</biom:TransactionDomain>
  
```

8.25. Domain Name - DNM

 TransactionDomainName

Field Reference: 1/DOM/DNM
Content Type: Data
XML Tag Name: TransactionDomainName
Data Type: ANS
Minimum Length: 1
Minimum Occurrences: 1
Value range: *n/a*
Code table: *n/a*
Base type: nc:TextType

Field ID: [01.013-A]
Condition: Mandatory within a field
Defined in: xsd/niem/biometrics/1.0/biometrics.xsd
Special Characters: ALL
Maximum Length: *
Maximum Occurrences: 1
Regular Expression: *n/a*
Namespace: <http://niem.gov/niem/biometrics/1.0>

XPath

```
/it1:PackageInformationRecord  
  ↪/biom:Transaction  
    ↪/biom:TransactionDomain  
      ↪/biom:TransactionDomainName
```

Summary

Uniquely identifies agency, entity, or implementation used for formatting the fields of the Type-2 record.

Notes

The domain name must be set to “INT-I”, representing the INTERPOL implementation.

Valid Examples

<code><biom:TransactionDomainName>INT-I</biom:TransactionDomainName></code>

8.26. Domain Version Number - DVN

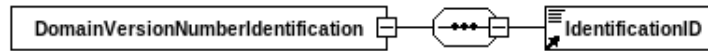

Field Reference: 1/DOM/DVN

Content Type: Data

XML Tag Name: DomainVersionNumberIdentification

Data Type: ANS

Minimum Length: 1

Minimum Occurrences: 1

Value range: *n/a*

Code table: *n/a*

Base type: niem-xsd:string

Field ID: [01.013-B]

Condition: Mandatory within a field

Defined in: xsd/niem/biometrics/1.0/biometrics.xsd

Special Characters: ALL

Maximum Length: *

Maximum Occurrences: 1

Regular Expression: *n/a*

Namespace: <http://niem.gov/niem/biometrics/1.0>

XPath

```
/itl:PackageInformationRecord
  ↳/biom:Transaction
    ↳/biom:TransactionDomain
      ↳/biom:DomainVersionNumberIdentification
        ↳/nc:IdentificationID
```

Summary

Unique version of the particular implementation.

Notes

Even though the XSD declares this field as optional, it must be specified in the INTERPOL implementation.

The domain version must be set to “0600”, representing major version 6 and minor version 00 of the INTERPOL implementation.

Valid Examples

```
<biom:DomainVersionNumberIdentification>
  <nc:IdentificationID>0600</nc:IdentificationID>
</biom:DomainVersionNumberIdentification>
```

8.27. Greenwich Mean Time (XML) - GMT

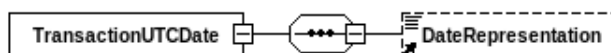

Field Reference: 1/GMT:X

Content Type: Data_X

XML Tag Name: TransactionUTCDate

Data Type: ANS

Minimum Length: 20

Minimum Occurrences: 1

Value range: *n/a*

Code table: *n/a*

Base type: [niem-xsd:date](#)

Field ID: [01.014:X]

Condition: Mandatory

Defined in: [xsd/niem/biometrics/1.0/biometrics.xsd](#)

Special Characters: [-:]

Maximum Length: 20

Maximum Occurrences: 1

Regular Expression: `\d{4}-\d{2}-\d{2}T\d{2}:\d{2}:\d{2}Z`

Namespace: <http://niem.gov/niem/biometrics/1.0>

XPath

```
/itl:PackageInformationRecord
  ↳/biom:Transaction
    ↳/biom:TransactionUTCDate
      ↳/nc:DateTime
```

Summary

Optional field with transaction date and time expressed in terms of Greenwich Mean Time units.

Notes

UTC has replaced GMT as the main reference time scale terminology, but the older terminology is retained in this standard for existing record types. In this standard, field 1.014 shall be taken to mean the UTC value.

Even though the xsd allows to specify a Date instead of a DateTime, DateTime should be preferred.

Valid Examples

```
<biom:TransactionUTCDate>
  <nc:DateTime>2007-01-01T00:00:01Z</nc:DateTime>
</biom:TransactionUTCDate>
```

8.28. Character Encoding - DCS

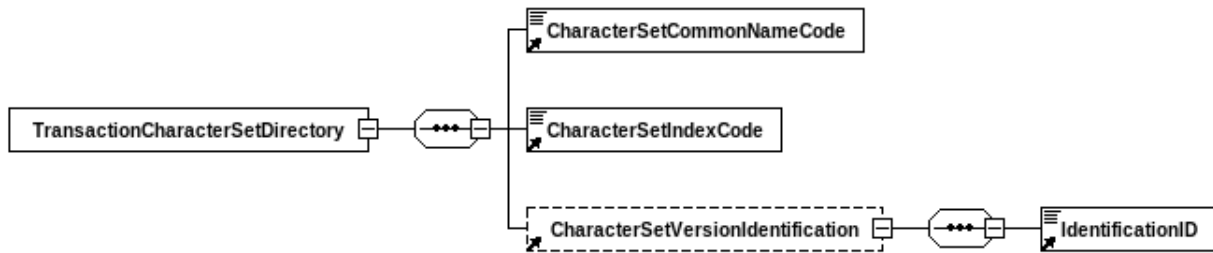

Field Reference: 1/DCS

Content Type: Set

XML Tag Name: TransactionCharacterSetDirectory

Data Type:

Minimum Length:

Minimum Occurrences: 0

Value range: *n/a*

Code table: *n/a*

Base type: biom:TransactionCharacterSetType

Field ID: [01.015]

Condition: Optional

Defined in: xsd/niem/biometrics/1.0/biometrics.xsd

Special Characters: *n/a*

Maximum Length:

Maximum Occurrences: 1

Regular Expression: *n/a*

Namespace: <http://niem.gov/niem/biometrics/1.0>

XPath

```

/itl:PackageInformationRecord
  ↳/biom:Transaction
    ↳/biom:TransactionCharacterSetDirectory
  
```

Summary

Specifies the character encoding that may appear within this transaction for data with the character type listed as "U" or 'user-defined' in the record format tables.

Notes

The default encoding and the only supported one. It is therefore not needed to fill up this field.

Moreover, it should be noted that the fact that the INTERPOL implementation of ANSI/NIST supports UTF-8 character encoding does not imply that the receiving AFIS will also support it. It is hence advised to restrict the characters used to the ASCII ones.

When non-ASCII characters need to be transmitted:

- the UTF-8 encoding should be used. Other encoding (such as latin-1) are not supported;
- the capacities of the receiving system must be checked beforehand.

Valid Examples

```
<biom:TransactionCharacterSetDirectory>
  <biom:CharacterSetCommonNameCode>UTF-8</biom:CharacterSetCommonNameCode>
  <biom:CharacterSetIndexCode>0</biom:CharacterSetIndexCode>
  <biom:CharacterSetVersionIdentification>
    <nc:IdentificationID>000</nc:IdentificationID>
  </biom:CharacterSetVersionIdentification>
</biom:TransactionCharacterSetDirectory>
```

8.29. Character Encoding Set Index - CSI

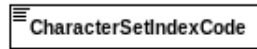

Field Reference: 1/DCS/CSI
Content Type: Data
XML Tag Name: CharacterSetIndexCode
Data Type: N
Minimum Length: 1
Minimum Occurrences: 1
Value range: {0..4,128..999}
Code table: see table [A.12](#) *
Base type: biom:CharacterSetIndexCodeType

Field ID: [01.015-A]
Condition: Mandatory within a field
Defined in: xsd/niem/biometrics/1.0/biometrics.xsd
Special Characters: *n/a*
Maximum Length: 3
Maximum Occurrences: 1
Regular Expression: *n/a*
Namespace: <http://niem.gov/niem/biometrics/1.0>

XPath

```
/itl:PackageInformationRecord  
  ↙/biom:Transaction  
    ↙/biom:TransactionCharacterSetDirectory  
      ↙/biom:CharacterSetIndexCode
```

Summary

A character set index number that references an associated character set throughout a transaction.

Valid Examples

```
<biom:CharacterSetIndexCode>0</biom:CharacterSetIndexCode>
```

*The code table is optional, defining commonly-used or special-purpose values, rather than definitive (listing all possible values).

8.30. Character Encoding Set Name - CSN

 CharacterSetCommonNameCode
--

Field Reference: 1/DCS/CSN	Field ID: [01.015-B]
Content Type: Data	Condition: Mandatory within a field
XML Tag Name: CharacterSetCommonNameCode	Defined in: xsd/niem/biometrics/1.0/biometrics.xsd
Data Type: ANS	Special Characters: ALL
Minimum Length: 1	Maximum Length: 16
Minimum Occurrences: 1	Maximum Occurrences: 1
Value range: <i>n/a</i>	Regular Expression: <i>n/a</i>
Code table: see table A.13 *	
Base type: biom:CharacterSetCommonNameCodeType	Namespace: http://niem.gov/niem/biometrics/1.0

XPath

```
/itl:PackageInformationRecord
  ↙/biom:Transaction
    ↙/biom:TransactionCharacterSetDirectory
      ↙/biom:CharacterSetCommonNameCode
```

Summary

A common name for the character set associated with index number.

Valid Examples

<code><biom:CharacterSetCommonNameCode>UTF-8</biom:CharacterSetCommonNameCode></code>

*The code table is optional, defining commonly-used or special-purpose values, rather than definitive (listing all possible values).

8.31. Character Encoding Set Version - CSV

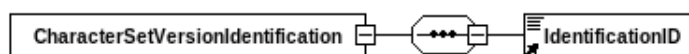

Field Reference: 1/DCS/CSV

Content Type: Data

XML Tag Name: CharacterSetVersionIdentification

Data Type: ANS

Minimum Length: 1

Minimum Occurrences: 0

Value range: *n/a*

Code table: *n/a*

Base type: niem-xsd:string

Field ID: [01.015-C]

Condition: Optional within a field

Defined in: xsd/niem/biometrics/1.0/biometrics.xsd

Special Characters: ALL

Maximum Length: 16

Maximum Occurrences: 1

Regular Expression: *n/a*

Namespace: <http://niem.gov/niem/biometrics/1.0>

XPath

```

/itl:PackageInformationRecord
  ↳/biom:Transaction
    ↳/biom:TransactionCharacterSetDirectory
      ↳/biom:CharacterSetVersionIdentification
        ↳/nc:IdentificationID
  
```

Summary

Specific version of the character encoding used.

Valid Examples

```
<biom:CharacterSetVersionIdentification><nc:Identification>000</nc:Identification></biom:CharacterSetVersionIdentification>
```

8.32. Application Profile Specifications - APS

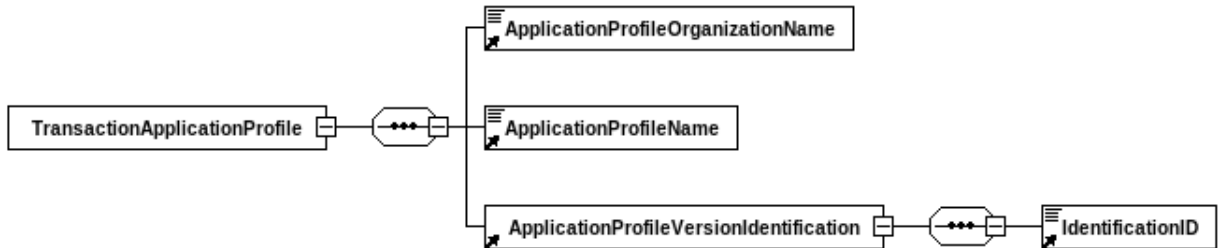

Field Reference: 1/APS

Content Type: Set

XML Tag Name: TransactionApplicationProfile

Data Type:

Minimum Length:

Minimum Occurrences: 0

Value range: *n/a*

Code table: *n/a*

Base type: biom:TransactionApplicationProfileType

Field ID: [01.016]

Condition: Optional

Defined in: xsd/niem/biometrics/1.0/biometrics.xsd

Special Characters: *n/a*

Maximum Length:

Maximum Occurrences: 0

Regular Expression: *n/a*

Namespace: <http://niem.gov/niem/biometrics/1.0>

Exceptions

see Technical Notes below

XPath

```

/it1:PackageInformationRecord
  ↳/biom:Transaction
    ↳/biom:TransactionApplicationProfile
  
```

Summary

Transaction's conformance with one or more specifications derived from specific implementations of ANSI/NIST (e.g., EBTS, INT-I, etc.)

Technical Notes

This field is not to be used in the INTERPOL's implementation as no profiles have been defined and should not be specified.

8.33. Application Profile Organization - APO

ApplicationProfileOrganizationName

Field Reference: 1/APS/APO

Content Type: Data

XML Tag Name: ApplicationProfileOrganizationName

Data Type: ANS

Minimum Length: 1

Minimum Occurrences: 1

Value range: *n/a*

Code table: *n/a*

Base type: nc:TextType

Field ID: [01.016-A]

Condition: Mandatory within a field

Defined in: xsd/niem/biometrics/1.0/biometrics.xsd

Special Characters: ALL

Maximum Length: *

Maximum Occurrences: 1

Regular Expression: *n/a*

Namespace: <http://niem.gov/niem/biometrics/1.0>

XPath

```
/it1:PackageInformationRecord
  ↙/biom:Transaction
    ↙/biom:TransactionApplicationProfile
      ↙/biom:ApplicationProfileOrganizationName
```

Summary

Agency or entity responsible for specification.

8.34. Application Profile Name - APN

 ApplicationProfileName

Field Reference: 1/APS/APN
Content Type: Data
XML Tag Name: ApplicationProfileName
Data Type: ANS
Minimum Length: 1
Minimum Occurrences: 1
Value range: *n/a*
Code table: *n/a*
Base type: nc:TextType

Field ID: [01.016-B]
Condition: Mandatory within a field
Defined in: xsd/niem/biometrics/1.0/biometrics.xsd
Special Characters: ALL
Maximum Length: *
Maximum Occurrences: 1
Regular Expression: *n/a*
Namespace: <http://niem.gov/niem/biometrics/1.0>

XPath

```
/it1:PackageInformationRecord  
  ↙/biom:Transaction  
    ↙/biom:TransactionApplicationProfile  
      ↙/biom:ApplicationProfileName
```

Summary

Name of specification.

8.35. Application Profile Version Number - APV

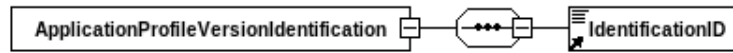

Field Reference: 1/APS/APV
Content Type: Data
XML Tag Name: ApplicationProfileVersionIdentification
Data Type: ANS
Minimum Length: 1
Minimum Occurrences: 1
Value range: *n/a*
Code table: *n/a*
Base type: niem-xsd:string

Field ID: [01.016-C]
Condition: Mandatory within a field
Defined in: xsd/niem/biometrics/1.0/biometrics.xsd
Special Characters: ALL
Maximum Length: *
Maximum Occurrences: 1
Regular Expression: *n/a*

Namespace: <http://niem.gov/niem/biometrics/1.0>

XPath

```
/itl:PackageInformationRecord  
  ↳/biom:Transaction  
    ↳/biom:TransactionApplicationProfile  
      ↳/biom:ApplicationProfileVersionIdentification  
        ↳/nc:IdentificationID
```

Summary

Specific version of specification.

8.36. Destination Agency Name - DAN

 OrganizationName

Field Reference: 1/ANM/DAN
Content Type: Data
XML Tag Name: OrganizationName
Data Type: ANS
Minimum Length: 1
Minimum Occurrences: 1
Value range: *n/a*
Code table: *n/a*
Base type: nc:TextType

Field ID: [01.017-A]
Condition: Mandatory within a field
Defined in: xsd/niem/niem-core/2.0/niem-core.xsd
Special Characters: ALL
Maximum Length: *
Maximum Occurrences: 1
Regular Expression: *n/a*
Namespace: <http://niem.gov/niem/niem-core/2.0>

XPath

```
/itl:PackageInformationRecord  
  ↙/biom:Transaction  
    ↙/int-i:TransactionDestinationOrganization  
      ↙/nc:OrganizationName
```

Summary

Name of the administration or organization designated to receive the transmission

Valid Examples

```
<nc:OrganizationName>BKA</nc:OrganizationName>
```

8.37. Originating Agency Name - OAN

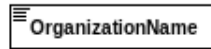

Field Reference: 1/ANM/OAN
Content Type: Data
XML Tag Name: OrganizationName
Data Type: ANS
Minimum Length: 1
Minimum Occurrences: 1
Value range: *n/a*
Code table: *n/a*
Base type: nc:TextType

Field ID: [01.017-B]
Condition: Mandatory within a field
Defined in: xsd/niem/niem-core/2.0/niem-core.xsd
Special Characters: ALL
Maximum Length: *
Maximum Occurrences: 1
Regular Expression: *n/a*

Namespace: <http://niem.gov/niem/niem-core/2.0>

XPath

```
/itl:PackageInformationRecord  
  ↙/biom:Transaction  
    ↙/int-i:TransactionOriginatingOrganization  
      ↙/nc:OrganizationName
```

Summary

Name of the administration or organization originating the transmission

Valid Examples

```
<nc:OrganizationName>FAED</nc:OrganizationName>
```

8.38. Destination Agency Country Code - DAC

LocationCountryISO3166Alpha3Code

Field Reference: 1/ANM/DAC
Content Type: Data_X
XML Tag Name: LocationCountryISO3166Alpha3Code
Data Type: A
Minimum Length: 3
Minimum Occurrences: 1
Value range: *n/a*
Code table: *n/a*
Base type: [int-i:ISO3166Alpha3CodeType](#)

Field ID: [01.017-C]
Condition: Mandatory within a field
Defined in: [xsd/int-i/1.0/int-i.xsd](#)
Special Characters: *n/a*
Maximum Length: 3
Maximum Occurrences: 1
Regular Expression: *n/a*
Namespace: <http://interpol.int/int-i/1.0>

XPath

```
/itl:PackageInformationRecord  
  ↳/biom:Transaction  
    ↳/int-i:TransactionDestinationOrganization  
      ↳/int-i:LocationCountryISO3166Alpha3Code
```

Summary

ISO 3166-1 Alpha-3 Country code of the administration or organization designated to receive the transmission

Notes

The country code is defined in ISO 3166-1 Alpha-3, extended with INTERPOL specific codes (see [4.2.3](#)).

Valid Examples

```
<int-i:LocationCountryISO3166Alpha3Code>DEU</int-i:LocationCountryISO3166Alpha3Code>
```

8.39. Originating Agency Country Code - OAC

LocationCountryISO3166Alpha3Code

Field Reference: 1/ANM/OAC
Content Type: Data_X
XML Tag Name: LocationCountryISO3166Alpha3Code
Data Type: A
Minimum Length: 3
Minimum Occurrences: 1
Value range: *n/a*
Code table: *n/a*
Base type: [int-i:ISO3166Alpha3CodeType](#)

Field ID: [01.017-D]
Condition: Mandatory within a field
Defined in: [xsd/int-i/1.0/int-i.xsd](#)
Special Characters: *n/a*
Maximum Length: 3
Maximum Occurrences: 1
Regular Expression: *n/a*

Namespace: <http://interpol.int/int-i/1.0>

XPath

```

/itl:PackageInformationRecord
└─/biom:Transaction
  └─/int-i:TransactionOriginatingOrganization
    └─/int-i:LocationCountryISO3166Alpha3Code
  
```

Summary

ISO 3166-1 Alpha-3 Country code of the administration or organization originating the transmission

Notes

The country code is defined in ISO 3166-1 Alpha-3, extended with INTERPOL specific codes (see [4.2.3](#)).

Valid Examples

<int-i:LocationCountryISO3166Alpha3Code>FRA</int-i:LocationCountryISO3166Alpha3Code>
--

8.40. Geographical Name Set - GNS

 TransactionGeographicNameSetCode
--

Field Reference: 1/GNS	Field ID: [01.018]
Content Type: Data_X	Condition: Optional
XML Tag Name: TransactionGeographicNameSetCode	Defined in: xsd/niem/biometrics/1.0/biometrics.xsd
Data Type: A	Special Characters: <i>n/a</i>
Minimum Length: 3	Maximum Length: 4
Minimum Occurrences: 0	Maximum Occurrences: 0
Value range: <i>n/a</i>	Regular Expression: <i>n/a</i>
Code table: <i>n/a</i>	
Base type: biom:TransactionGeographicNameSetCodeType	Namespace: http://niem.gov/niem/biometrics/1.0

Exceptions

see Technical Notes below

XPath

```
/itl:PackageInformationRecord
├─/biom:Transaction
│  └─/biom:TransactionGeographicNameSetCode
```

Summary

This optional field is used if the transaction uses GENC in lieu of ISO 3166-1 as a code set for country code specifications.

Technical Notes

This field is not to used in INTERPOL's implementation, as only ISO 3166-1 is supported. It should not be present.

8.41. Field Mandatoriness in Transaction Information Record

The following table shows a summary of the fields and information items in Transaction Information Record (Type 1), and in particular the fields and items that are mandatory.

Table 8.1.: Field Summary for Type 1 Records

Field Ref	Description	ATP	CPS	NPS	MPS	SRE	ERR
1	Package Information Record (XML)	M	M	M	M	M	M
1/XRCC:X	XML Record Category Code	M	M	M	M	M	M
1/VER_1/ANM	Transaction (XML)	M	M	M	M	M	M
1/VER:X1	Major Version	M	M	M	M	M	M
1/VER:X2	Minor Version	M	M	M	M	M	M
1/CNT:X	Transaction Content (XML)	M	M	M	M	M	M
1/CNT/FRC	First Record Category Code	M [^]	M [^]	M [^]	M [^]	M [^]	M [^]
1/CNT/CRC	Content Record Count	M [^]	M [^]	M [^]	M [^]	M [^]	M [^]
1/CNT/REC_1/CNT/IDC	Content Record Summary (XML)	M	M	M	M	M	M
1/CNT/REC:X	Record Category Code (XML)	M [^]	M [^]	M [^]	M [^]	M [^]	M [^]
1/CNT/IDC:X	Information Designation Character (XML)	M [^]	M [^]	M [^]	M [^]	M [^]	M [^]
1/TOT	Type of Transaction	M	M	M	M	M	M
1/DAT:X	Date (XML)	M	M	M	M	M	M
1/PRY	Priority	O	O	O	O	O	O
1/DAI_1/ANM/DAN	Transaction Destination Organization (XML)	M	M	M	M	M	M
1/DAI	Destination Agency Identifier	O	O	O	O	O	O
1/ORI_1/ANM/OAN	Transaction Originating Organization (XML)	M	M	M	M	M	M
1/ORI	Originating Agency Identifier	O	O	O	O	O	O
1/TCN	Transaction Control Number	M	M	M	M	M	M
1/TCR	Transaction Control Reference Number	O	O	O	O	O	M
1/NSR_1/NTR	Transaction Image Resolution Details (XML)	M	M	M	M	M	M
1/NSR:X	Native Scanning Resolution (XML)	M	M	M	M	M	M
1/NTR:X	Nominal Resolution (XML)	M	M	M	M	M	M
1/DOM	Domain Name	M	M	M	M	M	M
1/DOM/DNM	Domain Name	M [^]	M [^]	M [^]	M [^]	M [^]	M [^]
1/DOM/DVN	Domain Version Number	M [^]	M [^]	M [^]	M [^]	M [^]	M [^]
1/GMT:X	Greenwich Mean Time (XML)	M	M	M	M	M	M
1/DCS	Character Encoding	O	O	O	O	O	O
1/DCS/CSI	Character Encoding Set Index	M [^]	M [^]	M [^]	M [^]	M [^]	M [^]
1/DCS/CSN	Character Encoding Set Name	M [^]	M [^]	M [^]	M [^]	M [^]	M [^]
1/DCS/CSV	Character Encoding Set Version	O [^]	O [^]	O [^]	O [^]	O [^]	O [^]
1/APS	Application Profile Specifications	O	O	O	O	O	O
1/APS/APO	Application Profile Organization	M [^]	M [^]	M [^]	M [^]	M [^]	M [^]
1/APS/APN	Application Profile Name	M [^]	M [^]	M [^]	M [^]	M [^]	M [^]
1/APS/APV	Application Profile Version Number	M [^]	M [^]	M [^]	M [^]	M [^]	M [^]
1/ANM/DAN	Destination Agency Name	M [^]	M [^]	M [^]	M [^]	M [^]	M [^]
1/ANM/OAN	Originating Agency Name	M [^]	M [^]	M [^]	M [^]	M [^]	M [^]
1/ANM/DAC	Destination Agency Country Code	M [^]	M [^]	M [^]	M [^]	M [^]	M [^]
1/ANM/OAC	Originating Agency Country Code	M [^]	M [^]	M [^]	M [^]	M [^]	M [^]
1/GNS	Geographical Name Set	O	O	O	O	O	O

M=Mandatory, O=Optional, M[^]=Mandatory Info Item within a Field, O[^]=Optional Info Item within a Field, Dmp=Mandatory if another field is present (not permitted otherwise), Dop=Optional and only permitted if another field is present, Doa=Optional and only permitted if another field is absent, Dmv=Mandatory (and not permitted otherwise) if another field has a given value, Ds=Special condition

8.42. Type of Record Mandatoriness Depending on the TOT Value

Depending on the type of transaction, the structure of the message will vary. The following table shows the relation between a type of transaction and mandatory or optional presence of the different types of records.

Table 8.2.: Relation between types of transaction and record types

TOT	Type 1	Type 2	Type 9	Type 10	Type 13	Type 14	Type 15	Type 20
ATP	M	M		O		M	O	
CPS	M	M		O		M	O	
NPS	M	M		O		M	O	
MPS	M	M	O		M			O
SRE	M	M		O		O	O	
ERR	M	M						

M=Mandatory, O=Optional

9. User-defined Descriptive Text Record (aka Type 2)

This chapter describes all the fields that are used in the User-defined Descriptive Text Record. It first gives detailed information regarding each field, then gives an overview which focuses on the mandatoriness of each field.

9.1. Package Descriptive Text Record (XML)

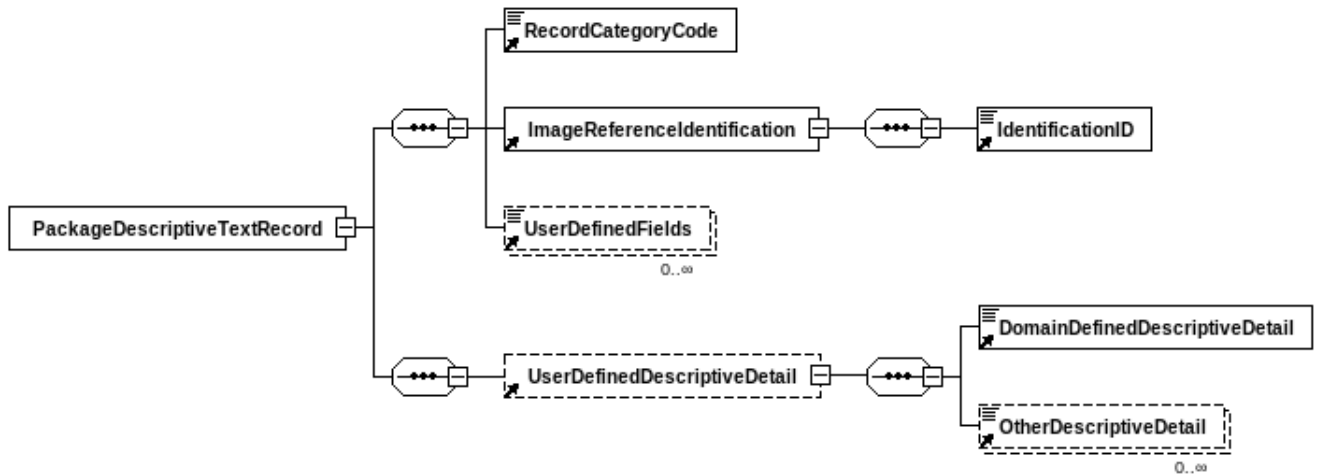

Field Reference: 2
Content Type: Set_X
XML Tag Name: PackageDescriptiveTextRecord
Data Type:
Minimum Length:
Minimum Occurrences: 0
Value range: *n/a*
Code table: *n/a*
Base type: itl:PackageDescriptiveTextRecordType

Field ID: [02]
Condition: Optional
Defined in: xsd/itl/2011/ITL-2007f-Package.xsd
Special Characters: *n/a*
Maximum Length:
Maximum Occurrences: *
Regular Expression: *n/a*
Namespace: <http://biometrics.nist.gov/standard/2011>

XPath

/itl:PackageDescriptiveTextRecord

Summary

Textual information relating to the subject of the transaction.

Notes

Even though the ANSI-NIST standard and the xsd would allow multiple Type 2 records to be packed in a single XML file, INTERPOL's implementation only allow one Type 2.

9.2. XML Record Category Code - XRCC

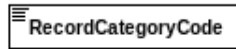

Field Reference: 2/XRCC:X
Content Type: Data_X
XML Tag Name: RecordCategoryCode
Data Type: N
Minimum Length: 1
Minimum Occurrences: 1
Value range: {2}
Code table: *n/a*
Base type: biom:RecordCategoryCodeType

Field ID: [02.001:X]
Condition: Mandatory
Defined in: xsd/niem/biometrics/1.0/biometrics.xsd
Special Characters: *n/a*
Maximum Length: 2
Maximum Occurrences: 1
Regular Expression: *n/a*
Namespace: <http://niem.gov/niem/biometrics/1.0>

XPath

```
/it1:PackageDescriptiveTextRecord  
  ↙/biom:RecordCategoryCode
```

Summary

Numeric representation of Record Type that the associated block of XML elements represent within the overall transaction, for example 1 for Type-1 Record Type, 14 for Type-14 Record Type. The Record Types are defined within the ANSI-NIST standard.

Valid Examples

```
<biom:RecordCategoryCode>2</biom:RecordCategoryCode>
```

Invalid Examples

```
<biom:RecordCategoryCode>02</biom:RecordCategoryCode>
```

9.3. Information Designation Character - IDC

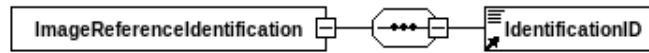

Field Reference: 2/IDC
Content Type: Data
XML Tag Name: ImageReferenceIdentification
Data Type: N
Minimum Length: 1
Minimum Occurrences: 1
Value range: {0..99}
Code table: *n/a*
Base type: niem-xsd:String

Field ID: [02.002]
Condition: Mandatory
Defined in: xsd/niem/biometrics/1.0/biometrics.xsd
Special Characters: *n/a*
Maximum Length: 2
Maximum Occurrences: 1
Regular Expression: *n/a*
Namespace: <http://niem.gov/niem/biometrics/1.0>

XPath

```
/it1:PackageDescriptiveTextRecord  
  ↙/biom:ImageReferenceIdentification  
    ↙/nc:IdentificationID
```

Summary

IDC assigned in 1.003-D to this Type-2 record.

Valid Examples

```
<biom:ImageReferenceIdentification><nc:IdentificationID>0</nc:IdentificationID></biom:ImageReferenceIdentification>
```

9.4. User-Defined Fields - UDF

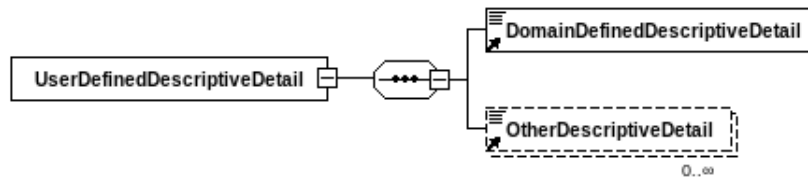

Field Reference: 2/UDF
Content Type: Set
XML Tag Name: UserDefinedDescriptiveDetail
Data Type:
Minimum Length:
Minimum Occurrences: 1
Value range: *n/a*
Code table: *n/a*
Base type: itl:UserDefinedDescriptiveDetailType

Field ID: [02.003_02.999]
Condition: Mandatory
Defined in: xsd/itl/2011/ITL-2007f-Package.xsd
Special Characters: *n/a*
Maximum Length:
Maximum Occurrences: 1
Regular Expression: *n/a*

Namespace: <http://biometrics.nist.gov/standard/2011>

XPath

```

/itl:PackageDescriptiveTextRecord
  ↪/itl:UserDefinedDescriptiveDetail
    
```

Summary

A set of user-defined descriptive information about the transaction.

9.5. Domain-Defined Fields

Field Reference: 2/UDF:X1	Field ID: [02.003_02.999:X1]
Content Type: Set_X	Condition: Mandatory
XML Tag Name: DomainDefinedDescriptiveDetail	Defined in: xsd/int-i/1.0/int-i.xsd
Data Type:	Special Characters: n/a
Minimum Length:	Maximum Length:
Minimum Occurrences: 1	Maximum Occurrences: 1
Value range: n/a	Regular Expression: n/a
Code table: n/a	
Base type: int-i:DomainDefinedDescriptiveDetailType	Namespace: http://interpol.int/int-i/1.0

XPath

```
/itl:PackageDescriptiveTextRecord
└─/itl:UserDefinedDescriptiveDetail
   └─/int-i:DomainDefinedDescriptiveDetail
```

Summary

INTERPOL's Domain descriptive information about the transaction.

9. User-defined Descriptive Text Record (aka Type 2)

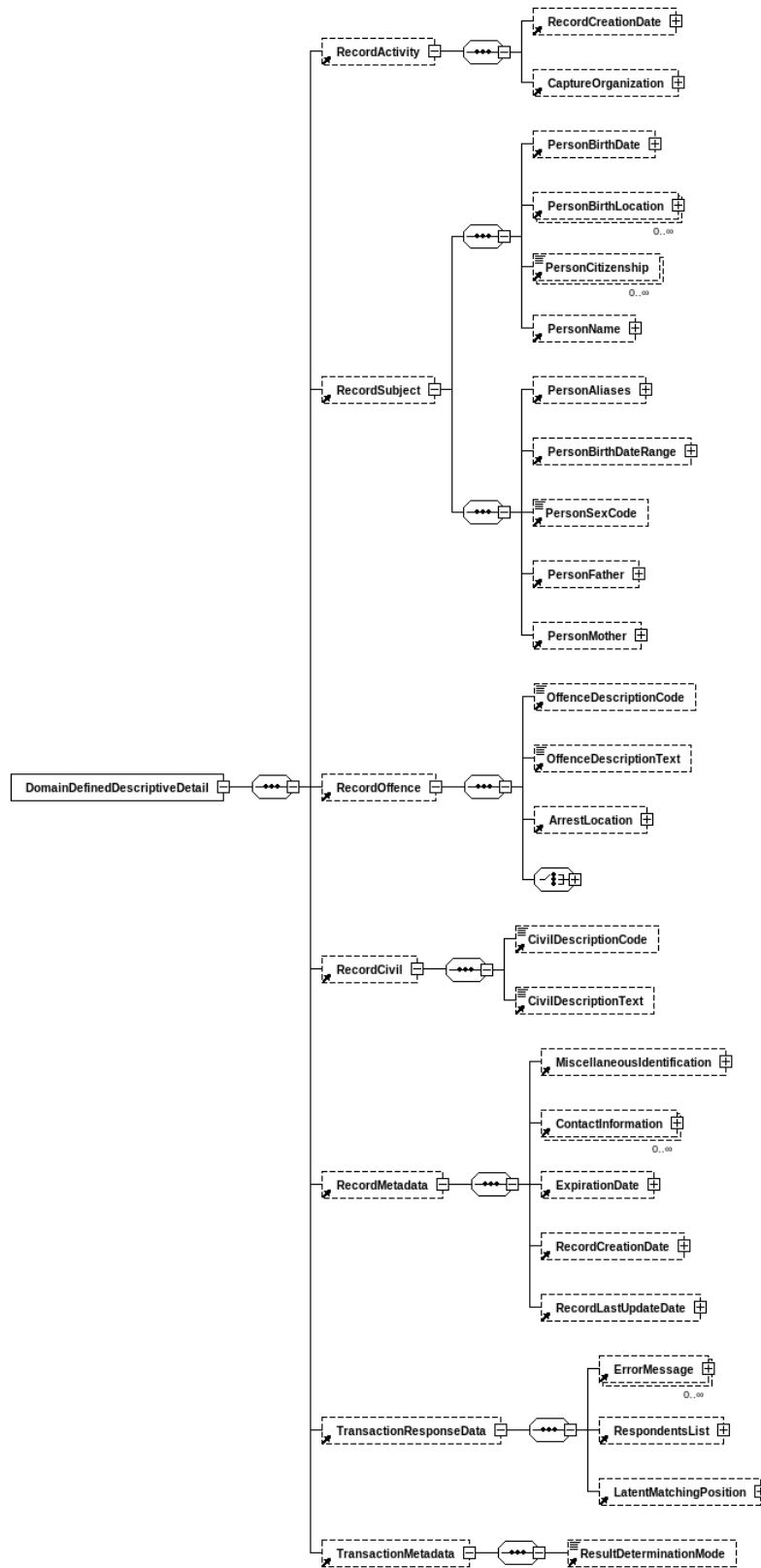

9.6. Record Activity Fields

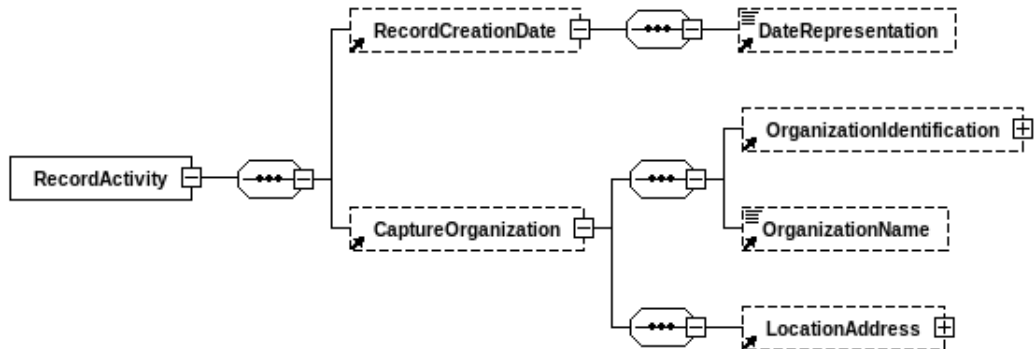

Field Reference: 2/UDF:X1/RAC
Content Type: Set_X
XML Tag Name: RecordActivity
Data Type:
Minimum Length:
Minimum Occurrences: 0
Value range: *n/a*
Code table: *n/a*
Base type: int-i:RecordActivityType

Field ID: [02.003_02.999:X1-A]
Condition: Optional
Defined in: xsd/int-i/1.0/int-i.xsd
Special Characters: *n/a*
Maximum Length:
Maximum Occurrences: 1
Regular Expression: *n/a*
Namespace: <http://interpol.int/int-i/1.0>

XPath

```

/itl:PackageDescriptiveTextRecord
  ↙/itl:UserDefinedDescriptiveDetail
    ↙/int-i:DomainDefinedDescriptiveDetail
      ↙/int-i:RecordActivity
  
```

Summary

Record Activity groups all the elements related to where and when the record was created.

9.7. Record Subject Fields

Field Reference: 2/UDF:X1/RSU
Content Type: Set_X
XML Tag Name: RecordSubject
Data Type:
Minimum Length:
Minimum Occurrences: 0
Value range: *n/a*
Code table: *n/a*
Base type: int-i:RecordSubjectType

Field ID: [02.003_02.999:X1-B]
Condition: Optional
Defined in: xsd/int-i/1.0/int-i.xsd
Special Characters: *n/a*
Maximum Length:
Maximum Occurrences: 1
Regular Expression: *n/a*
Namespace: <http://interpol.int/int-i/1.0>

XPath

```
/itl:PackageDescriptiveTextRecord  
  ↳/itl:UserDefinedDescriptiveDetail  
    ↳/int-i:DomainDefinedDescriptiveDetail  
      ↳/int-i:RecordSubject
```

Summary

Record Subject groups all the alpha-numeric elements related to the person or latent.

9. User-defined Descriptive Text Record (aka Type 2)

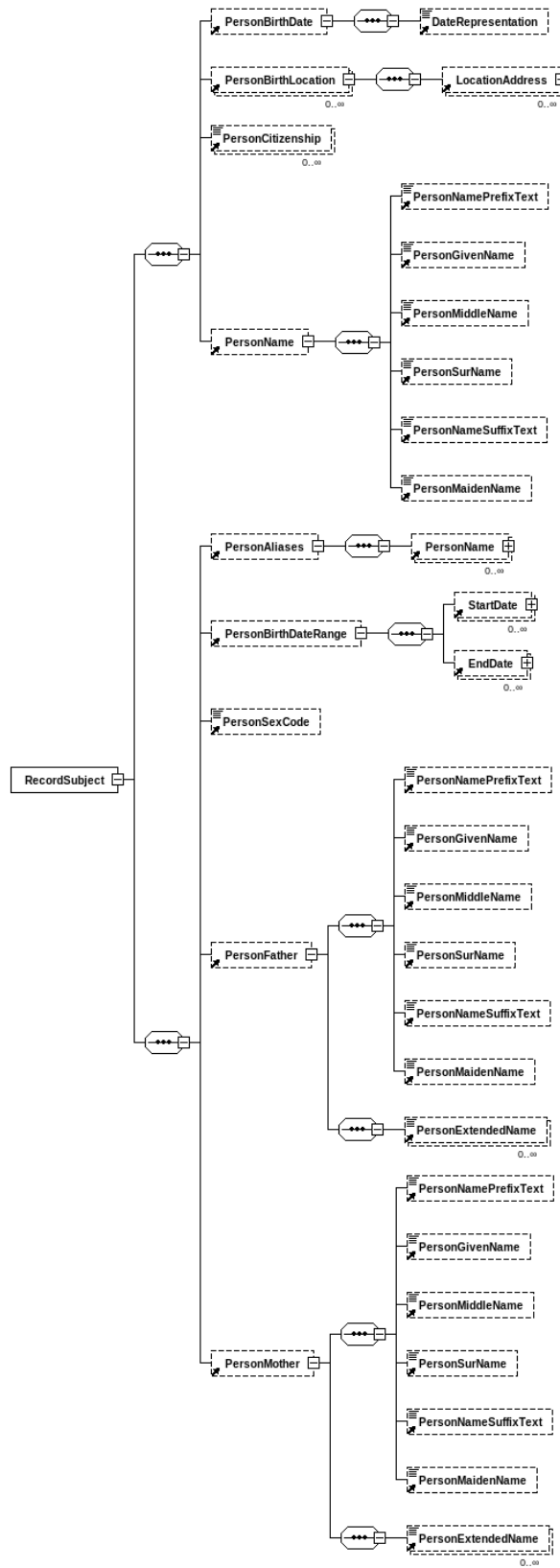

9.8. Record Offence Fields

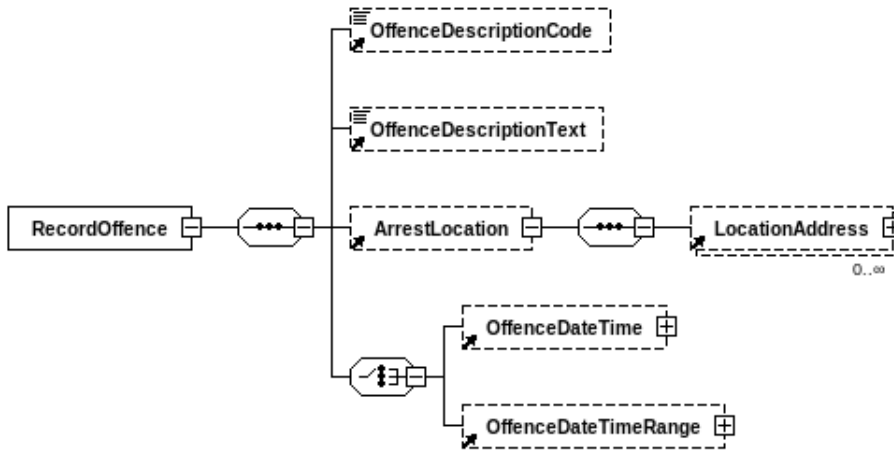

Field Reference: 2/UDF:X1/ROF
Content Type: Set_X
XML Tag Name: RecordOffence
Data Type:
Minimum Length:
Minimum Occurrences: 0
Value range: *n/a*
Code table: *n/a*
Base type: int-i:RecordOffenceType

Field ID: [02.003_02.999:X1-C]
Condition: Dependent (see table)
Defined in: xsd/int-i/1.0/int-i.xsd
Special Characters: *n/a*
Maximum Length:
Maximum Occurrences: 1
Regular Expression: *n/a*
Namespace: <http://interpol.int/int-i/1.0>

Dependency table

Type of dependency	Value
Optional on Value of other Field, should not be set otherwise.	[1/TOT]="CPS" [1/TOT]="MPS" [1/TOT]="ATP"

XPath

```

/itl:PackageDescriptiveTextRecord
├── /itl:UserDefinedDescriptiveDetail
│   ├── /int-i:DomainDefinedDescriptiveDetail
│   │   └── /int-i:RecordOffence
    
```

Summary

Record Offence groups all the elements related to the reason for the criminal application.

9.9. Record Civil Fields

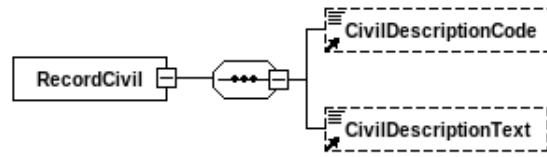

Field Reference: 2/UDF:X1/RCI
Content Type: Set_X
XML Tag Name: RecordCivil
Data Type:
Minimum Length:
Minimum Occurrences: 0
Value range: *n/a*
Code table: *n/a*
Base type: int-i:RecordCivilType

Field ID: [02.003_02.999:X1-D]
Condition: Dependent (see table)
Defined in: xsd/int-i/1.0/int-i.xsd
Special Characters: *n/a*
Maximum Length:
Maximum Occurrences: 1
Regular Expression: *n/a*
Namespace: <http://interpol.int/int-i/1.0>

Dependency table

Type of dependency	Value
Optional on Value of other Field, should not be set otherwise.	[1/TOT]="NPS"

XPath

```

/itl:PackageDescriptiveTextRecord
├─/itl:UserDefinedDescriptiveDetail
│   └─/int-i:DomainDefinedDescriptiveDetail
│       └─/int-i:RecordCivil
    
```

Summary

Record Civil groups all the elements related to the reason for the non-criminal application.

9.10. Record Metadata Fields

Field Reference: 2/UDF:X1/RME
Content Type: Set_X
XML Tag Name: RecordMetadata
Data Type:
Minimum Length:
Minimum Occurrences: 1
Value range: *n/a*
Code table: *n/a*
Base type: int-i:RecordMetadataType

Field ID: [02.003_02.999:X1-E]
Condition: Mandatory
Defined in: xsd/int-i/1.0/int-i.xsd
Special Characters: *n/a*
Maximum Length:
Maximum Occurrences: 1
Regular Expression: *n/a*
Namespace: <http://interpol.int/int-i/1.0>

XPath

```
/itl:PackageDescriptiveTextRecord
└─/itl:UserDefinedDescriptiveDetail
   └─/int-i:DomainDefinedDescriptiveDetail
      └─/int-i:RecordMetadata
```

Summary

Record Metadata groups additional elements, in particular all the identifiers of the records.

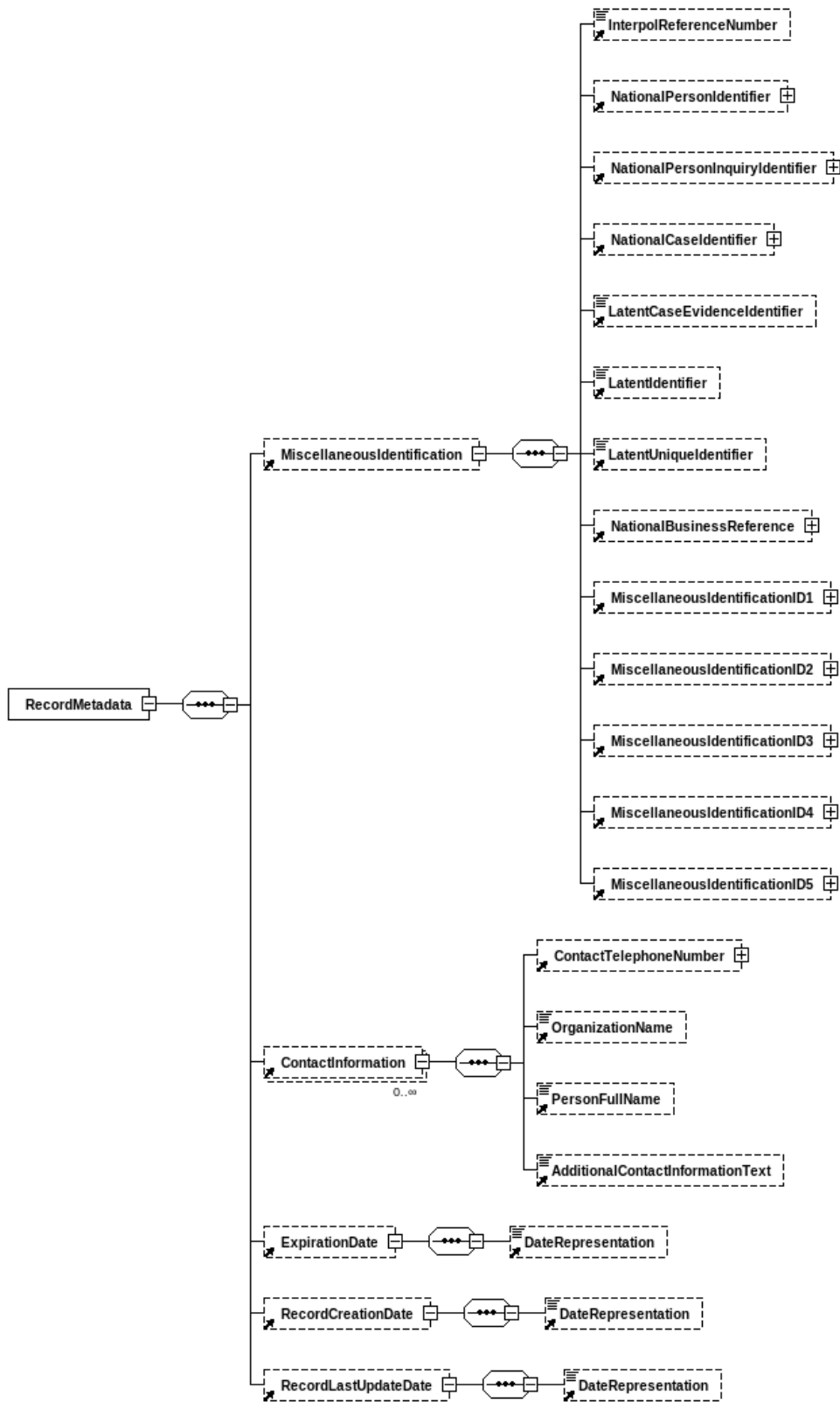

9.11. Transaction Response Data Fields

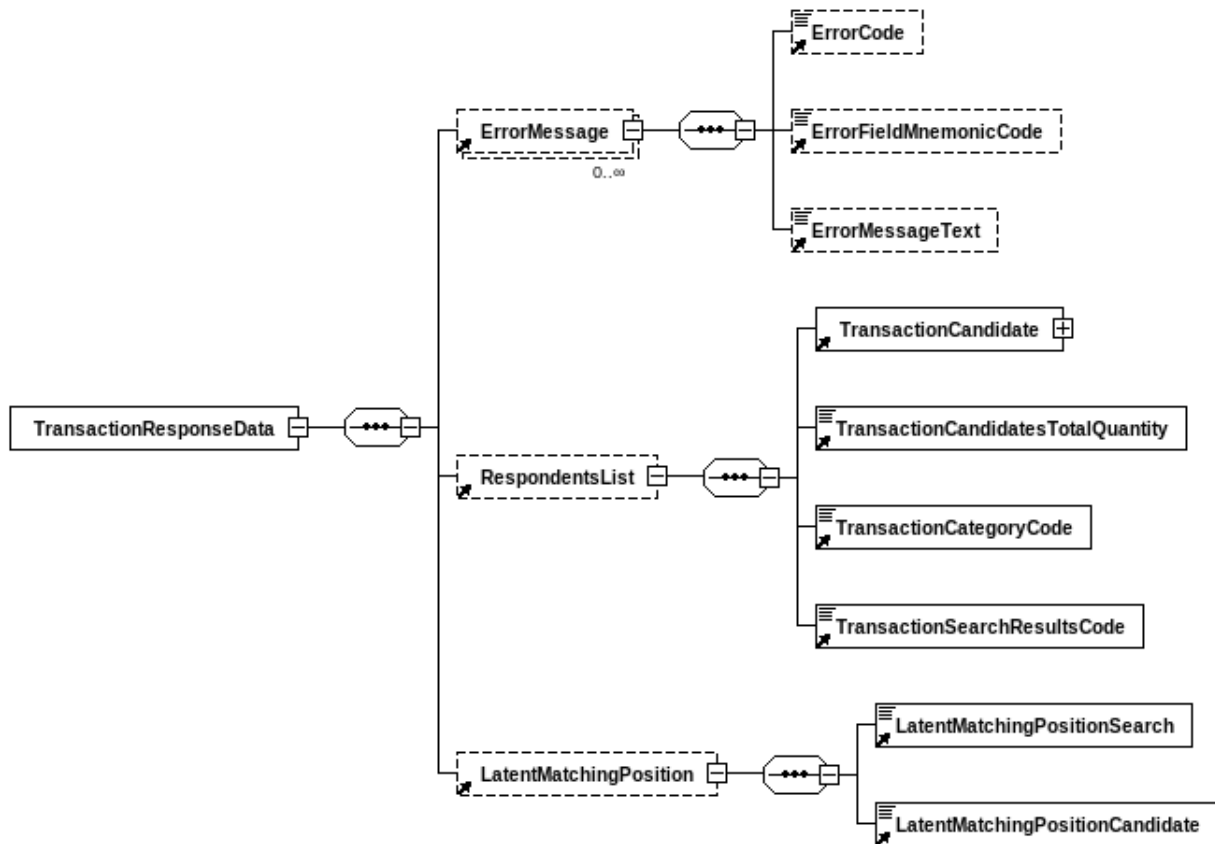

Field Reference: 2/UDF:X1/TRD
Content Type: Set_X
XML Tag Name: TransactionResponseData
Data Type:
Minimum Length:
Minimum Occurrences: 0
Value range: n/a
Code table: n/a
Base type: int-i:TransactionResponseDataType

Field ID: [02.003_02.999:X1-F]
Condition: Dependent (see table)
Defined in: xsd/int-i/1.0/int-i.xsd
Special Characters: n/a
Maximum Length:
Maximum Occurrences: 1
Regular Expression: n/a
Namespace: <http://interpol.int/int-i/1.0>

Dependency table

Type of dependency	Value
Mandatory on Value of other Field, optional otherwise.	[1/TOT]="SRE"

XPath

```

/itl:PackageDescriptiveTextRecord
├── /itl:UserDefinedDescriptiveDetail
│   └── /int-i:DomainDefinedDescriptiveDetail
│       └── /int-i:TransactionResponseData
    
```

Summary

Transaction Response Data groups all the elements related to a response: error, respondents, ...

9.12. Transaction Metadata Fields

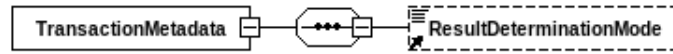

Field Reference: 2/UDF:X1/TMD
Content Type: Set_X
XML Tag Name: TransactionMetadata
Data Type:
Minimum Length:
Minimum Occurrences: 0
Value range: *n/a*
Code table: *n/a*
Base type: int-i:TransactionMetadataType

Field ID: [02.003_02.999:X1-G]
Condition: Optional
Defined in: xsd/int-i/1.0/int-i.xsd
Special Characters: *n/a*
Maximum Length:
Maximum Occurrences: 1
Regular Expression: *n/a*
Namespace: <http://interpol.int/int-i/1.0>

XPath

```

/itl:PackageDescriptiveTextRecord
  ↳/itl:UserDefinedDescriptiveDetail
    ↳/int-i:DomainDefinedDescriptiveDetail
      ↳/int-i:TransactionMetadata
    
```

Summary

Transaction Meta Data groups all the elements related to the processing of the transaction.

9.13. Custom Defined Fields

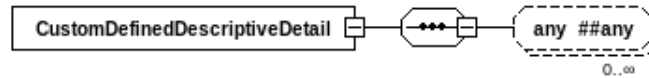

Field Reference: 2/UDF:X2
Content Type: Set_X
XML Tag Name: CustomDefinedDescriptiveDetail
Data Type:
Minimum Length:
Minimum Occurrences: 0
Value range: *n/a*
Code table: *n/a*
Base type: int-i:CustomDefinedDescriptiveDetailType

Field ID: [02.003_02.999:X2]
Condition: Optional
Defined in: xsd/int-i/1.0/int-i.xsd
Special Characters: *n/a*
Maximum Length:
Maximum Occurrences: *
Regular Expression: *n/a*
Namespace: <http://interpol.int/int-i/1.0>

Exceptions
 see Technical Notes below

XPath

```
/itl:PackageDescriptiveTextRecord
  ↳/itl:UserDefinedDescriptiveDetail
    ↳/int-i:CustomDefinedDescriptiveDetail
```

Summary

Custom Defined Domain is a placeholder where the implementer can put any custom field (not part of the INTERPOL implementation).

Technical Notes

Anything in this placeholder won't be validated against the xsd.

9.14. Date of Record - DAR

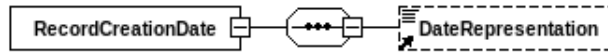

Field Reference: 2/DAR

Content Type: Data

XML Tag Name: RecordCreationDate

Data Type: ANS

Minimum Length: 10

Minimum Occurrences: 0

Value range: *n/a*

Code table: *n/a*

Base type: [niem-xsd:date](#) or [niem-xsd:dateTime](#)

Field ID: [02.004]

Condition: Optional

Defined in: [xsd/int-i/1.0/int-i.xsd](#)

Special Characters: [-:]

Maximum Length: 20

Maximum Occurrences: 1

Regular Expression: `\d{2}(T\d{2}:\d{2}:\d{2}(Z){0,1}){0,1}`

`\d{4}-\d{2}-`

Namespace: <http://interpol.int/int-i/1.0>

XPath

```

/itl:PackageDescriptiveTextRecord
  ↳/itl:UserDefinedDescriptiveDetail
    ↳/itl:DomainDefinedDescriptiveDetail
      ↳/int-i:RecordMetadata
        ↳/int-i:RecordCreationDate
          ↳/nc:DateTime
or
/itl:PackageDescriptiveTextRecord
  ↳/itl:UserDefinedDescriptiveDetail
    ↳/itl:DomainDefinedDescriptiveDetail
      ↳/int-i:RecordMetadata
        ↳/int-i:RecordCreationDate
          ↳/nc:Date

```

Summary

Date (and Time), in ISO 8601 format, on which the record was first created.

Notes

This date is the date when the record (the electronic file) was created by the system, be it a livescan or an AFIS, independently from the date when the fingerprints were actually captured.

Valid Examples

```

<int-i:RecordCreationDate>
  <nc:Date>2017-07-11</nc:Date>
</int-i:RecordCreationDate>
or
<int-i:RecordCreationDate>
  <nc:DateTime>2017-07-11T00:00:01Z</nc:DateTime>
</int-i:RecordLastUpdateDate>

```

9.15. Date of Last Update - DLU

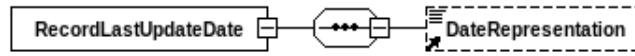

Field Reference: 2/DLU
Content Type: Data
XML Tag Name: RecordLastUpdateDate
Data Type: ANS
Minimum Length: 10
Minimum Occurrences: 0
Value range: *n/a*
Code table: *n/a*
Base type: `niem-xsd:date` or `niem-xsd:dateTime`

Field ID: [02.005]
Condition: Optional
Defined in: `xsd/int-i/1.0/int-i.xsd`
Special Characters: [-:]
Maximum Length: 20
Maximum Occurrences: 1
Regular Expression: `\d{4}-\d{2}-\d{2}(T\d{2}:\d{2}:\d{2}(Z){0,1}){0,1}`
Namespace: <http://interpol.int/int-i/1.0>

XPath

```

/itl:PackageDescriptiveTextRecord
  ↳/itl:UserDefinedDescriptiveDetail
    ↳/itl:DomainDefinedDescriptiveDetail
      ↳/int-i:RecordMetadata
        ↳/int-i:RecordLastUpdateDate
          ↳/nc:DateTime
or
/itl:PackageDescriptiveTextRecord
  ↳/itl:UserDefinedDescriptiveDetail
    ↳/itl:DomainDefinedDescriptiveDetail
      ↳/int-i:RecordMetadata
        ↳/int-i:RecordLastUpdateDate
          ↳/nc>Date
  
```

Summary

Date (and Time), in ISO 8601 format, on which the record was last updated.

Notes

This date is the date when the record (the electronic file) was last updated by the system. This can be used in particular to explicitate when a composite record was last recalculated in a multi-incident AFIS.

Valid Examples

```

<int-i:RecordLastUpdateDate>
  <nc>Date>2017-07-11</nc>Date>
</int-i:RecordLastUpdateDate>
or
<int-i:RecordLastUpdateDate>
  <nc:DateTime>2017-07-11T00:00:01</nc:DateTime>
</int-i:RecordLastUpdateDate>
  
```

9.16. Case Reference (XML) - CNO

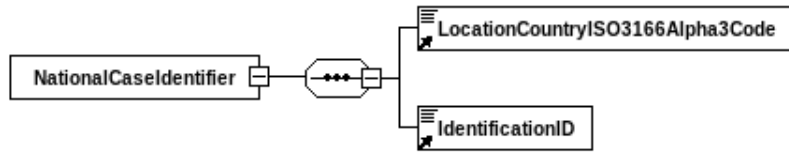

Field Reference: 2/CNO:X
Content Type: Set_X
XML Tag Name: NationalCaseIdentifier
Data Type:
Minimum Length:
Minimum Occurrences: 0
Value range: *n/a*
Code table: *n/a*
Base type: [int-i:NationalIdentifierType](#)

Field ID: [02.007-A_02.007-B]
Condition: Dependent (see table)
Defined in: [xsd/int-i/1.0/int-i.xsd](#)
Special Characters: *n/a*
Maximum Length:
Maximum Occurrences: 1
Regular Expression: *n/a*
Namespace: <http://interpol.int/int-i/1.0>

Dependency table

Type of dependency	Value
Mandatory on Value of other Field, optional otherwise.	[1/TOT]="MPS" [1/TOT]="SRE" and [2/RLS/SRC]="I" and [2/RLS/CAC]="CPS"

XPath

```

/itl:PackageDescriptiveTextRecord
  ↙/itl:UserDefinedDescriptiveDetail
    ↙/itl:DomainDefinedDescriptiveDetail
      ↙/int-i:RecordMetadata
        ↙/int-i:MiscellaneousIdentification
          ↙/int-i:NationalCaseIdentifier
    
```

Summary

The National Case Identifier (CNO) is a number assigned by the local fingerprint bureau to a collection of latents found at a crime scene.

It is made up of 2 subfields: a ISO3166 Alpha-3 country code identifying the country owning the case, and the case identifier itself

Valid Examples

```

<int-i:NationalCaseIdentifier>
  <int-i:LocationCountryISO3166Alpha3Code>DEU</int-i:LocationCountryISO3166Alpha3Code>
  <nc:IdentificationID>47110815</nc:IdentificationID>
</int-i:NationalCaseIdentifier>
    
```

9.17. Case Reference Country - CN1

LocationCountryISO3166Alpha3Code

Field Reference: 2/CNO:X/CN1

Content Type: Data_X

XML Tag Name: LocationCountryISO3166Alpha3Code

Data Type: A

Minimum Length: 3

Minimum Occurrences: 0

Value range: *n/a*

Code table: *n/a*

Base type: [int-i:ISO3166Alpha3CodeType](#)

Field ID: [02.007-A]

Condition: Mandatory within a field

Defined in: [xsd/int-i/1.0/int-i.xsd](#)

Special Characters: *n/a*

Maximum Length: 3

Maximum Occurrences: 1

Regular Expression: *n/a*

Namespace: <http://interpol.int/int-i/1.0>

XPath

```
/itl:PackageDescriptiveTextRecord
├── /itl:UserDefinedDescriptiveDetail
│   ├── /itl:DomainDefinedDescriptiveDetail
│   │   ├── /int-i:RecordMetadata
│   │   │   ├── /int-i:MiscellaneousIdentification
│   │   │   │   ├── /int-i:NationalCaseIdentifier
│   │   │   │   │   └── /int-i:LocationCountryISO3166Alpha3Code
```

Summary

The ISO3166 Alpha-3 country code of the country that assigned the Country Case Reference.

Valid Examples

```
<int-i:LocationCountryISO3166Alpha3Code>DEU</int-i:LocationCountryISO3166Alpha3Code>
```

9.18. Case Reference Identifier - CN2



Field Reference: 2/CNO:X/CN2
Content Type: Data_X
XML Tag Name: IdentificationID
Data Type: ANS
Minimum Length: 1
Minimum Occurrences: 1
Value range: *n/a*
Code table: *n/a*
Base type: niem-xsd:String

Field ID: [02.007-B]
Condition: Mandatory within a field
Defined in: xsd/niem/niem-core/2.0/niem-core.xsd
Special Characters: [/, -]
Maximum Length: 32
Maximum Occurrences: 1
Regular Expression: *n/a*

Namespace: <http://niem.gov/niem/niem-core/2.0>

XPath

```
/itl:PackageDescriptiveTextRecord  
  ↳/itl:UserDefinedDescriptiveDetail  
    ↳/itl:DomainDefinedDescriptiveDetail  
      ↳/int-i:RecordMetadata  
        ↳/int-i:MiscellaneousIdentification  
          ↳/int-i:NationalCaseIdentifier  
            ↳/nc:IdentificationID
```

Summary

The value of the Country Case Reference, according the local guidelines of the country.

Valid Examples

```
<nc:IdentificationID>47110815</nc:IdentificationID>
```

9.19. Evidence Identifier - SQN

LatentCaseEvidenceIdentifier

Field Reference: 2/SQN

Content Type: Data

XML Tag Name: LatentCaseEvidenceIdentifier

Data Type: AN

Minimum Length: 1

Minimum Occurrences: 0

Value range: *n/a*

Code table: *n/a*

Base type: nc:TextType

Field ID: [02.008]

Condition: Dependent (see table)

Defined in: xsd/int-i/1.0/int-i.xsd

Special Characters: *n/a*

Maximum Length: 32

Maximum Occurrences: 1

Regular Expression: *n/a*

Namespace: <http://interpol.int/int-i/1.0>

Dependency table

Type of dependency	Value
Mandatory on Value of other Field, optional otherwise.	[1/TOT]="MPS" [1/TOT]="SRE" and [2/RLS/SRC]="I" and [2/RLS/CAC]="CPS"

XPath

```
/itl:PackageDescriptiveTextRecord
└─/itl:UserDefinedDescriptiveDetail
  └─/itl:DomainDefinedDescriptiveDetail
    └─/int-i:RecordMetadata
      └─/int-i:LatentCaseEvidenceIdentifier
```

Summary

This specifies each evidence within a case.

A evidence is a latent or group of latents which are grouped together for the purposes of filing and/or searching. This definition implies that even single latents will still have to be assigned a evidence number.

In the case of search requests the field is included for identification purposes: if the remote system is an AFR system it can use the case number, evidence number and latent identifier to determine whether it already has an AFR encoding of the latent.

This field together with MID (Field 2.009) may be included to identify a particular latent within a evidence.

Valid Examples

```
<int-i:LatentCaseEvidenceIdentifier>>Evidence001</int-i:LatentCaseEvidenceIdentifier>
```

9.20. Latent Identifier - MID

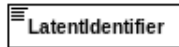

Field Reference: 2/MID

Content Type: Data

XML Tag Name: LatentIdentifier

Data Type: AN

Minimum Length: 1

Minimum Occurrences: 0

Value range: *n/a*

Code table: *n/a*

Base type: nc:TextType

Field ID: [02.009]

Condition: Dependent (see table)

Defined in: xsd/int-i/1.0/int-i.xsd

Special Characters: *n/a*

Maximum Length: 32

Maximum Occurrences: 1

Regular Expression: *n/a*

Namespace: <http://interpol.int/int-i/1.0>

Dependency table

Type of dependency	Value
Mandatory on Value of other Field, optional otherwise.	[1/TOT]="MPS" [1/TOT]="SRE" and [2/RLS/SRC]="I" and [2/RLS/CAC]="CPS"

XPath

```
/itl:PackageDescriptiveTextRecord
├─/itl:UserDefinedDescriptiveDetail
│   └─/itl:DomainDefinedDescriptiveDetail
│       └─/int-i:RecordMetadata
│           └─/int-i:LatentIdentifier
```

Summary

This specifies the individual latent within a evidence.

This field is used analog to the evidence identifier discussed in the description for SQN (Field 2.008).

Valid Examples

```
<int-i:LatentIdentifier>001</int-i:LatentIdentifier>
```

9.21. Criminal Reference Number (XML) - CRN

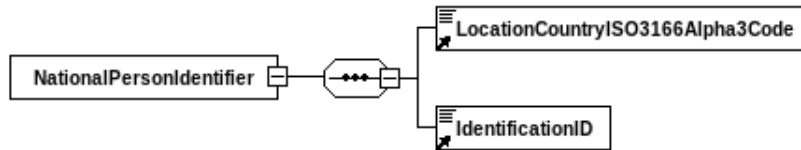

Field Reference: 2/CRN:X
Content Type: Set_X
XML Tag Name: NationalPersonIdentifier
Data Type:
Minimum Length:
Minimum Occurrences: 0
Value range: *n/a*
Code table: *n/a*
Base type: [int-i:NationalIdentifierType](#)

Field ID: [02.010-A_02.010-B]
Condition: Dependent (see table)
Defined in: [xsd/int-i/1.0/int-i.xsd](#)
Special Characters: *n/a*
Maximum Length:
Maximum Occurrences: 1
Regular Expression: *n/a*
Namespace: <http://interpol.int/int-i/1.0>

Dependency table

Type of dependency	Value
Mandatory on Absence of other Field	[2/ORN:X]
Mandatory on Value of other Field, optional otherwise.	[1/TOT]="CPS" [1/TOT]="NPS" [1/TOT]="ATP" [1/TOT]="SRE" and [2/RLS/SRC]="I" and [2/RLS/CAC]="CPS"

XPath

```

/itl:PackageDescriptiveTextRecord
├── /itl:UserDefinedDescriptiveDetail
│   ├── /itl:DomainDefinedDescriptiveDetail
│   │   ├── /int-i:RecordMetadata
│   │   │   ├── /int-i:MiscellaneousIdentification
│   │   │   └── /int-i:NationalPersonIdentifier
  
```

Summary

The Person Identifier (CRN) is a mandatory reference (if ORN is absent) and would be expected in any Person transaction. It should be unique within the country creating the reference and static (i.e. unchanging) for the person the biometrics relate to. It is traditionally an identity level reference rather than an event level reference and would be the primary key into all related information on the person within the country.

It is made up of 2 subfields: a ISO3166 Alpha-3 country code identifying the country owning the Person, and the reference number itself.

Valid Examples

```

<int-i:NationalPersonIdentifier>
  <int-i:LocationCountryISO3166Alpha3Code>DEU</int-i:LocationCountryISO3166Alpha3Code>
  <nc:IdentificationID>1234567890</nc:IdentificationID>
</int-i:NationalPersonIdentifier>
  
```

9.22. Country Code of the Criminal Reference Number - CR1

LocationCountryISO3166Alpha3Code

Field Reference: 2/CRN:X/CR1
Content Type: Data_X
XML Tag Name: LocationCountryISO3166Alpha3Code
Data Type: A
Minimum Length: 3
Minimum Occurrences: 0
Value range: *n/a*
Code table: *n/a*
Base type: [int-i:ISO3166Alpha3CodeType](#)

Field ID: [02.010-A]
Condition: Mandatory within a field
Defined in: xsd/int-i/1.0/int-i.xsd
Special Characters: *n/a*
Maximum Length: 3
Maximum Occurrences: 1
Regular Expression: *n/a*
Namespace: <http://interpol.int/int-i/1.0>

XPath

```
/itl:PackageDescriptiveTextRecord
├─ /itl:UserDefinedDescriptiveDetail
│   └─ /itl:DomainDefinedDescriptiveDetail
│       └─ /int-i:RecordMetadata
│           └─ /int-i:MiscellaneousIdentification
│               └─ /int-i:NationalPersonIdentifier
│                   └─ /int-i:LocationCountryISO3166Alpha3Code
```

Summary

The ISO3166 Alpha-3 country code of the country that owns the Person .

Valid Examples

```
<int-i:LocationCountryISO3166Alpha3Code>DEU</int-i:LocationCountryISO3166Alpha3Code>
```

9.23. Criminal Reference Number Value - CR2



Field Reference: 2/CRN:X/CR2
Content Type: Data_X
XML Tag Name: IdentificationID
Data Type: ANS
Minimum Length: 1
Minimum Occurrences: 1
Value range: *n/a*
Code table: *n/a*
Base type: niem-xsd:String

Field ID: [02.010-B]
Condition: Mandatory within a field
Defined in: xsd/niem/niem-core/2.0/niem-core.xsd
Special Characters: *n/a*
Maximum Length: 32
Maximum Occurrences: 1
Regular Expression: *n/a*
Namespace: <http://niem.gov/niem/niem-core/2.0>

XPath

```
/itl:PackageDescriptiveTextRecord  
  ↳/itl:UserDefinedDescriptiveDetail  
    ↳/itl:DomainDefinedDescriptiveDetail  
      ↳/int-i:RecordMetadata  
        ↳/int-i:MiscellaneousIdentification  
          ↳/int-i:NationalPersonIdentifier  
            ↳/nc:IdentificationID
```

Summary

The value of the Reference Number, according the local guidelines of the country.

Valid Examples

```
<nc:IdentificationID>1234567890</nc:IdentificationID>
```

9.24. Business Reference Number (XML) - ORN

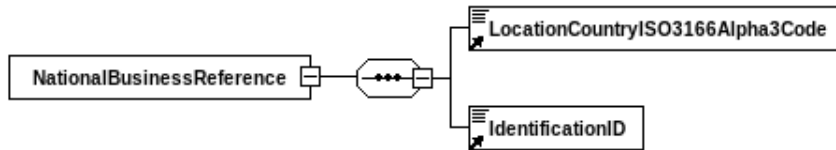

Field Reference: 2/ORN:X
Content Type: Set_X
XML Tag Name: NationalBusinessReference
Data Type:
Minimum Length:
Minimum Occurrences: 0
Value range: *n/a*
Code table: *n/a*
Base type: [int-i:NationalIdentifierType](#)

Field ID: [02.011-A_02.011-B]
Condition: Dependent (see table)
Defined in: [xsd/int-i/1.0/int-i.xsd](#)
Special Characters: *n/a*
Maximum Length:
Maximum Occurrences: 10
Regular Expression: *n/a*
Namespace: <http://interpol.int/int-i/1.0>

Dependency table

Type of dependency	Value
Mandatory on Absence of other Field	[2/CRN:X]
Mandatory on Value of other Field, optional otherwise.	[1/TOT]="CPS" [1/TOT]="NPS" [1/TOT]="ATP" [1/TOT]="SRE" and [2/RLS/SRC]="I" and [2/RLS/CAC]="CPS"

XPath

```

/itl:PackageDescriptiveTextRecord
  ↳/itl:UserDefinedDescriptiveDetail
    ↳/itl:DomainDefinedDescriptiveDetail
      ↳/int-i:RecordMetadata
        ↳/int-i:MiscellaneousIdentification
          ↳/int-i:NationalBusinessReference
    
```

Summary

The Business Reference Number (ORN) is an optional field. It would typically contain an event level reference from the country that purpose of biometrics where submitted for. It is anticipated as being unique with the country. Where submitted, it is intended that this would be shared back in any future interactions relating to the original biometric submission, allowing the submission party to more easily identify identify the context for initial response or future enquirers. It would allow the country to differentiate between biometric submission of the same person submitted on multiple occasions, over time. The source of the business reference is open for the individual country to decide; this could be an arrest event or warrant related reference. Whilst this could also be workflow event reference from the country's submission system, this reference is in addition to the mandated TCN and TCR elements.

It is made up of 2 subfields: a ISO3166 Alpha-3 country code identifying the country owning the Person, and the reference number itself.

Valid Examples

```
<int-i:NationalBusinessReference>  
  <int-i:LocationCountryISO3166Alpha3Code>DEU</int-i:LocationCountryISO3166Alpha3Code>  
  <nc:IdentificationID>1234567890</nc:IdentificationID>  
</int-i:NationalBusinessReference>
```

9.25. Country Code of the Business Reference Number - OR1

LocationCountryISO3166Alpha3Code

Field Reference: 2/ORN:X/OR1
Content Type: Data_X
XML Tag Name: LocationCountryISO3166Alpha3Code
Data Type: A
Minimum Length: 3
Minimum Occurrences: 0
Value range: *n/a*
Code table: *n/a*
Base type: [int-i:ISO3166Alpha3CodeType](#)

Field ID: [02.011-A]
Condition: Mandatory within a field
Defined in: [xsd/int-i/1.0/int-i.xsd](#)
Special Characters: *n/a*
Maximum Length: 3
Maximum Occurrences: 1
Regular Expression: *n/a*
Namespace: <http://interpol.int/int-i/1.0>

XPath

```
/itl:PackageDescriptiveTextRecord
├─ /itl:UserDefinedDescriptiveDetail
│   └─ /itl:DomainDefinedDescriptiveDetail
│       └─ /int-i:RecordMetadata
│           └─ /int-i:MiscellaneousIdentification
│               └─ /int-i:NationalBusinessReference
│                   └─ /int-i:LocationCountryISO3166Alpha3Code
```

Summary

The ISO3166 Alpha-3 country code of the country that gave the Business Reference .

Valid Examples

```
<int-i:LocationCountryISO3166Alpha3Code>DEU</int-i:LocationCountryISO3166Alpha3Code>
```

9.26. Business Reference Number Value - OR2



Field Reference: 2/ORN:X/OR2
Content Type: Data_X
XML Tag Name: IdentificationID
Data Type: ANS
Minimum Length: 1
Minimum Occurrences: 0
Value range: *n/a*
Code table: *n/a*
Base type: niem-xsd:String

Field ID: [02.011-B]
Condition: Mandatory within a field
Defined in: xsd/niem/niem-core/2.0/niem-core.xsd
Special Characters: *n/a*
Maximum Length: 32
Maximum Occurrences: 1
Regular Expression: *n/a*
Namespace: <http://niem.gov/niem/niem-core/2.0>

XPath

```
/itl:PackageDescriptiveTextRecord
├─ /itl:UserDefinedDescriptiveDetail
│   └─ /itl:DomainDefinedDescriptiveDetail
│       └─ /int-i:RecordMetadata
│           └─ /int-i:MiscellaneousIdentification
│               └─ /int-i:NationalBusinessReference
│                   └─ /nc:IdentificationID
```

Summary

The value of the Business Reference Number, according the local guidelines of the country.

Valid Examples

```
<nc:IdentificationID>1234567890</nc:IdentificationID>
```

9.27. Miscellaneous Identification Number 1 (XML) - MN1



Field Reference: 2/MN1:X
Content Type: Set_X
XML Tag Name: MiscellaneousIdentificationID1
Data Type:
Minimum Length:
Minimum Occurrences: 0
Value range: *n/a*
Code table: *n/a*
Base type: int-i:MiscellaneousIdentificationIDXType

Field ID: [02.012-A_02.012-B]
Condition: Optional
Defined in: xsd/int-i/1.0/int-i.xsd
Special Characters: *n/a*
Maximum Length:
Maximum Occurrences: 1
Regular Expression: *n/a*
Namespace: <http://interpol.int/int-i/1.0>

XPath

```

/itl:PackageDescriptiveTextRecord
├── /itl:UserDefinedDescriptiveDetail
│   ├── /itl:DomainDefinedDescriptiveDetail
│   │   ├── /int-i:RecordMetadata
│   │   │   ├── /int-i:MiscellaneousIdentification
│   │   │   │   └── /int-i:MiscellaneousIdentificationID1
    
```

Summary

Any miscellaneous reference number can be entered in this field.

Valid Examples

```

<int-i:MiscellaneousIdentificationID1>
  <int-i:MiscIDType>type of ID 1</int-i:MiscIDType>
  <nc:IdentificationID>MISC1</nc:IdentificationID>
</int-i:MiscellaneousIdentificationID1>
    
```

9.28. Miscellaneous Identification Number 1 (XML) – Type - MN1T

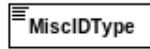

Field Reference: 2/MN1:X/MN1T
Content Type: Data_X
XML Tag Name: MiscIDType
Data Type: ANS
Minimum Length: 1
Minimum Occurrences: 0
Value range: *n/a*
Code table: *n/a*
Base type: nc:TextType

Field ID: [02.012-A]
Condition: Optional within a field
Defined in: xsd/int-i/1.0/int-i.xsd
Special Characters: *n/a*
Maximum Length: 32
Maximum Occurrences: 1
Regular Expression: *n/a*
Namespace: <http://interpol.int/int-i/1.0>

XPath

```
/itl:PackageDescriptiveTextRecord
├─ /itl:UserDefinedDescriptiveDetail
│   └─ /itl:DomainDefinedDescriptiveDetail
│       └─ /int-i:RecordMetadata
│           └─ /int-i:MiscellaneousIdentification
│               └─ /int-i:MiscellaneousIdentificationID1
│                   └─ /int-i:MiscIDType
```

Summary

Type of the miscellaneous identifier, for instance “Social Security Number” or “CNP”

Valid Examples

```
<int-i:MiscIDType>type of ID 1</int-i:MiscIDType>
```

9.29. Miscellaneous Identification Number 1 (XML) – Value - MN1V

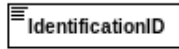

Field Reference: 2/MN1:X/MN1V
Content Type: Data_X
XML Tag Name: IdentificationID
Data Type: ANS
Minimum Length: 1
Minimum Occurrences: 1
Value range: *n/a*
Code table: *n/a*
Base type: niem-xsd:String

Field ID: [02.012-B]
Condition: Mandatory within a field
Defined in: xsd/niem/niem-core/2.0/niem-core.xsd
Special Characters: *n/a*
Maximum Length: 32
Maximum Occurrences: 1
Regular Expression: *n/a*
Namespace: <http://niem.gov/niem/niem-core/2.0>

XPath

```
/itl:PackageDescriptiveTextRecord
├── /itl:UserDefinedDescriptiveDetail
│   ├── /itl:DomainDefinedDescriptiveDetail
│   │   ├── /int-i:RecordMetadata
│   │   │   ├── /int-i:MiscellaneousIdentification
│   │   │   │   ├── /int-i:MiscellaneousIdentificationID1
│   │   │   │   │   └── /nc:IdentificationID
```

Summary

Value of the miscellaneous identifier

Valid Examples

```
<nc:IdentificationID>MISC1</nc:IdentificationID>
```

9.30. Miscellaneous Identification Number 2 (XML) - MN2



Field Reference: 2/MN2:X
Content Type: Set_X
XML Tag Name: MiscellaneousIdentificationID2
Data Type:
Minimum Length:
Minimum Occurrences: 0
Value range: *n/a*
Code table: *n/a*
Base type: int-i:MiscellaneousIdentificationIDType

Field ID: [02.013-A_02.013-B]
Condition: Optional
Defined in: xsd/int-i/1.0/int-i.xsd
Special Characters: *n/a*
Maximum Length:
Maximum Occurrences: 1
Regular Expression: *n/a*
Namespace: <http://interpol.int/int-i/1.0>

XPath

```

/itl:PackageDescriptiveTextRecord
├── /itl:UserDefinedDescriptiveDetail
│   ├── /itl:DomainDefinedDescriptiveDetail
│   │   ├── /int-i:RecordMetadata
│   │   │   ├── /int-i:MiscellaneousIdentification
│   │   │   │   └── /int-i:MiscellaneousIdentificationID2
    
```

Summary

Any miscellaneous reference number can be entered in this field.

Valid Examples

```

<int-i:MiscellaneousIdentificationID2>
  <int-i:MiscIDType>type of ID 2</int-i:MiscIDType>
  <nc:IdentificationID>MISC2</nc:IdentificationID>
</int-i:MiscellaneousIdentificationID2>
    
```

9.31. Miscellaneous Identification Number 2 (XML) – Type - MN2T

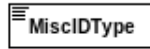

Field Reference: 2/MN2:X/MN2T
Content Type: Data_X
XML Tag Name: MiscIDType
Data Type: ANS
Minimum Length: 1
Minimum Occurrences: 0
Value range: *n/a*
Code table: *n/a*
Base type: nc:TextType

Field ID: [02.013-A]
Condition: Optional within a field
Defined in: xsd/int-i/1.0/int-i.xsd
Special Characters: *n/a*
Maximum Length: 32
Maximum Occurrences: 1
Regular Expression: *n/a*
Namespace: <http://interpol.int/int-i/1.0>

XPath

```
/itl:PackageDescriptiveTextRecord
├─ /itl:UserDefinedDescriptiveDetail
│   └─ /itl:DomainDefinedDescriptiveDetail
│       └─ /int-i:RecordMetadata
│           └─ /int-i:MiscellaneousIdentification
│               └─ /int-i:MiscellaneousIdentificationID2
│                   └─ /int-i:MiscIDType
```

Summary

Type of the miscellaneous identifier, for instance “Social Security Number” or “CNP”

Valid Examples

```
<int-i:MiscIDType>type of ID 2</int-i:MiscIDType>
```

9.32. Miscellaneous Identification Number 2 (XML) – Value - MN2V

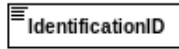

Field Reference: 2/MN2:X/MN2V
Content Type: Data_X
XML Tag Name: IdentificationID
Data Type: ANS
Minimum Length: 1
Minimum Occurrences: 1
Value range: *n/a*
Code table: *n/a*
Base type: niem-xsd:String

Field ID: [02.013-B]
Condition: Mandatory within a field
Defined in: xsd/niem/niem-core/2.0/niem-core.xsd
Special Characters: *n/a*
Maximum Length: 32
Maximum Occurrences: 1
Regular Expression: *n/a*
Namespace: <http://niem.gov/niem/niem-core/2.0>

XPath

```
/itl:PackageDescriptiveTextRecord
├─ /itl:UserDefinedDescriptiveDetail
│   └─ /itl:DomainDefinedDescriptiveDetail
│       └─ /int-i:RecordMetadata
│           └─ /int-i:MiscellaneousIdentification
│               └─ /int-i:MiscellaneousIdentificationID2
│                   └─ /nc:IdentificationID
```

Summary

Value of the miscellaneous identifier

Valid Examples

```
<nc:IdentificationID>MISC2</nc:IdentificationID>
```

9.33. Miscellaneous Identification Number 3 (XML) - MN3

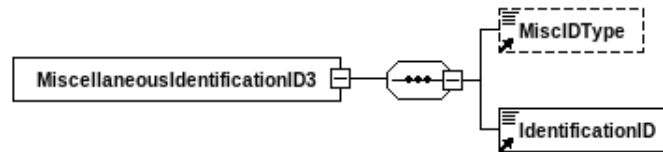

Field Reference: 2/MN3:X
Content Type: Set_X
XML Tag Name: MiscellaneousIdentificationID3
Data Type:
Minimum Length:
Minimum Occurrences: 0
Value range: *n/a*
Code table: *n/a*
Base type: int-i:MiscellaneousIdentificationID3Type

Field ID: [02.014-A_02.014-B]
Condition: Optional
Defined in: xsd/int-i/1.0/int-i.xsd
Special Characters: *n/a*
Maximum Length:
Maximum Occurrences: 1
Regular Expression: *n/a*
Namespace: <http://interpol.int/int-i/1.0>

XPath

```

/itl:PackageDescriptiveTextRecord
├── /itl:UserDefinedDescriptiveDetail
│   ├── /itl:DomainDefinedDescriptiveDetail
│   │   ├── /int-i:RecordMetadata
│   │   │   ├── /int-i:MiscellaneousIdentification
│   │   │   │   └── /int-i:MiscellaneousIdentificationID3
  
```

Summary

Any miscellaneous reference number can be entered in this field.

Valid Examples

```

<int-i:MiscellaneousIdentificationID3>
  <int-i:MiscIDType>type of ID 3</int-i:MiscIDType>
  <nc:IdentificationID>MISC3</nc:IdentificationID>
</int-i:MiscellaneousIdentificationID3>
  
```

9.34. Miscellaneous Identification Number 3 (XML) – Type - MN3T

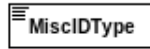

Field Reference: 2/MN3:X/MN3T
Content Type: Data_X
XML Tag Name: MiscIDType
Data Type: ANS
Minimum Length: 1
Minimum Occurrences: 0
Value range: *n/a*
Code table: *n/a*
Base type: nc:TextType

Field ID: [02.014-A]
Condition: Optional within a field
Defined in: xsd/int-i/1.0/int-i.xsd
Special Characters: *n/a*
Maximum Length: 32
Maximum Occurrences: 1
Regular Expression: *n/a*
Namespace: <http://interpol.int/int-i/1.0>

XPath

```
/itl:PackageDescriptiveTextRecord
├─ /itl:UserDefinedDescriptiveDetail
│   └─ /itl:DomainDefinedDescriptiveDetail
│       └─ /int-i:RecordMetadata
│           └─ /int-i:MiscellaneousIdentification
│               └─ /int-i:MiscellaneousIdentificationID3
│                   └─ /int-i:MiscIDType
```

Summary

Type of the miscellaneous identifier, for instance “Social Security Number” or “CNP”

Valid Examples

```
<int-i:MiscIDType>type of ID 3</int-i:MiscIDType>
```

9.35. Miscellaneous Identification Number 3 (XML) – Value - MN3V

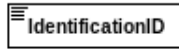

Field Reference: 2/MN3:X/MN3V
Content Type: Data_X
XML Tag Name: IdentificationID
Data Type: ANS
Minimum Length: 1
Minimum Occurrences: 1
Value range: *n/a*
Code table: *n/a*
Base type: niem-xsd:String

Field ID: [02.014-B]
Condition: Mandatory within a field
Defined in: xsd/niem/niem-core/2.0/niem-core.xsd
Special Characters: *n/a*
Maximum Length: 32
Maximum Occurrences: 1
Regular Expression: *n/a*
Namespace: <http://niem.gov/niem/niem-core/2.0>

XPath

```
/itl:PackageDescriptiveTextRecord  
  ↳/itl:UserDefinedDescriptiveDetail  
    ↳/itl:DomainDefinedDescriptiveDetail  
      ↳/int-i:RecordMetadata  
        ↳/int-i:MiscellaneousIdentification  
          ↳/int-i:MiscellaneousIdentificationID3  
            ↳/nc:IdentificationID
```

Summary

Value of the miscellaneous identifier

Valid Examples

```
<nc:IdentificationID>MISC3</nc:IdentificationID>
```

9.36. Miscellaneous Identification Number 4 (XML) - MN4



Field Reference: 2/MN4:X
Content Type: Set_X
XML Tag Name: MiscellaneousIdentificationID4
Data Type:
Minimum Length:
Minimum Occurrences: 0
Value range: *n/a*
Code table: *n/a*
Base type: int-i:MiscellaneousIdentificationIDType

Field ID: [02.015-A_02.015-B]
Condition: Optional
Defined in: xsd/int-i/1.0/int-i.xsd
Special Characters: *n/a*
Maximum Length:
Maximum Occurrences: 1
Regular Expression: *n/a*
Namespace: <http://interpol.int/int-i/1.0>

XPath

```

/itl:PackageDescriptiveTextRecord
├── /itl:UserDefinedDescriptiveDetail
│   ├── /itl:DomainDefinedDescriptiveDetail
│   │   ├── /int-i:RecordMetadata
│   │   │   ├── /int-i:MiscellaneousIdentification
│   │   │   │   └── /int-i:MiscellaneousIdentificationID4
    
```

Summary

Any miscellaneous reference number can be entered in this field.

Valid Examples

```

<int-i:MiscellaneousIdentificationID4>
  <int-i:MiscIDType>type of ID 4</int-i:MiscIDType>
  <nc:IdentificationID>MISC4</nc:IdentificationID>
</int-i:MiscellaneousIdentificationID4>
    
```

9.37. Miscellaneous Identification Number 4 (XML) - MN4T

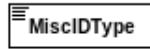

Field Reference: 2/MN4:X/MN4T
Content Type: Data_X
XML Tag Name: MiscIDType
Data Type: ANS
Minimum Length: 1
Minimum Occurrences: 0
Value range: *n/a*
Code table: *n/a*
Base type: nc:TextType

Field ID: [02.015-A]
Condition: Optional within a field
Defined in: xsd/int-i/1.0/int-i.xsd
Special Characters: *n/a*
Maximum Length: 32
Maximum Occurrences: 1
Regular Expression: *n/a*
Namespace: <http://interpol.int/int-i/1.0>

XPath

```
/itl:PackageDescriptiveTextRecord
├─ /itl:UserDefinedDescriptiveDetail
│   └─ /itl:DomainDefinedDescriptiveDetail
│       └─ /int-i:RecordMetadata
│           └─ /int-i:MiscellaneousIdentification
│               └─ /int-i:MiscellaneousIdentificationID4
│                   └─ /int-i:MiscIDType
```

Summary

Type of the miscellaneous identifier, for instance “Social Security Number” or “CNP”

Valid Examples

```
<int-i:MiscIDType>type of ID 4</int-i:MiscIDType>
```

9.38. Miscellaneous Identification Number 4 (XML) - MN4V

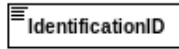

Field Reference: 2/MN4:X/MN4V
Content Type: Data_X
XML Tag Name: IdentificationID
Data Type: ANS
Minimum Length: 1
Minimum Occurrences: 1
Value range: *n/a*
Code table: *n/a*
Base type: niem-xsd:String

Field ID: [02.015-B]
Condition: Mandatory within a field
Defined in: xsd/niem/niem-core/2.0/niem-core.xsd
Special Characters: *n/a*
Maximum Length: 32
Maximum Occurrences: 1
Regular Expression: *n/a*
Namespace: <http://niem.gov/niem/niem-core/2.0>

XPath

```
/itl:PackageDescriptiveTextRecord  
  ↳/itl:UserDefinedDescriptiveDetail  
    ↳/itl:DomainDefinedDescriptiveDetail  
      ↳/int-i:RecordMetadata  
        ↳/int-i:MiscellaneousIdentification  
          ↳/int-i:MiscellaneousIdentificationID4  
            ↳/nc:IdentificationID
```

Summary

Value of the miscellaneous identifier

Valid Examples

```
<nc:IdentificationID>MISC4</nc:IdentificationID>
```

9.39. Miscellaneous Identification Number 5 (XML) - MN5

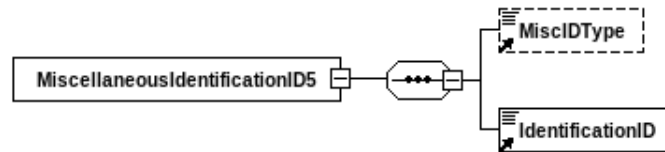

Field Reference: 2/MN5:X
Content Type: Set_X
XML Tag Name: MiscellaneousIdentificationID5
Data Type:
Minimum Length:
Minimum Occurrences: 0
Value range: *n/a*
Code table: *n/a*
Base type: int-i:MiscellaneousIdentificationID5Type

Field ID: [02.016-A_02.016-B]
Condition: Optional
Defined in: xsd/int-i/1.0/int-i.xsd
Special Characters: *n/a*
Maximum Length:
Maximum Occurrences: 1
Regular Expression: *n/a*
Namespace: <http://interpol.int/int-i/1.0>

XPath

```

/itl:PackageDescriptiveTextRecord
├── /itl:UserDefinedDescriptiveDetail
│   ├── /itl:DomainDefinedDescriptiveDetail
│   │   ├── /int-i:RecordMetadata
│   │   │   ├── /int-i:MiscellaneousIdentification
│   │   │   │   └── /int-i:MiscellaneousIdentificationID5
  
```

Summary

Any miscellaneous reference number can be entered in this field.

Valid Examples

```

<int-i:MiscellaneousIdentificationID5>
  <int-i:MiscIDType>type of ID 5</int-i:MiscIDType>
  <nc:IdentificationID>MISC5</nc:IdentificationID>
</int-i:MiscellaneousIdentificationID5>
  
```

9.40. Miscellaneous Identification Number 5 (XML) - MN5T

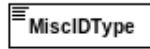

Field Reference: 2/MN5:X/MN5T
Content Type: Data_X
XML Tag Name: MiscIDType
Data Type: ANS
Minimum Length: 1
Minimum Occurrences: 0
Value range: *n/a*
Code table: *n/a*
Base type: nc:TextType

Field ID: [02.016-A]
Condition: Optional within a field
Defined in: xsd/int-i/1.0/int-i.xsd
Special Characters: *n/a*
Maximum Length: 32
Maximum Occurrences: 1
Regular Expression: *n/a*
Namespace: <http://interpol.int/int-i/1.0>

XPath

```
/itl:PackageDescriptiveTextRecord
├─ /itl:UserDefinedDescriptiveDetail
│   └─ /itl:DomainDefinedDescriptiveDetail
│       └─ /int-i:RecordMetadata
│           └─ /int-i:MiscellaneousIdentification
│               └─ /int-i:MiscellaneousIdentificationID5
│                   └─ /int-i:MiscIDType
```

Summary

Type of the miscellaneous identifier, for instance “Social Security Number” or “CNP”

Valid Examples

```
<int-i:MiscIDType>type of ID 5</int-i:MiscIDType>
```

9.41. Miscellaneous Identification Number 5 (XML) - MN5V

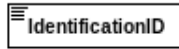

Field Reference: 2/MN5:X/MN5V
Content Type: Data_X
XML Tag Name: IdentificationID
Data Type: ANS
Minimum Length: 1
Minimum Occurrences: 1
Value range: *n/a*
Code table: *n/a*
Base type: niem-xsd:String

Field ID: [02.016-B]
Condition: Mandatory within a field
Defined in: xsd/niem/niem-core/2.0/niem-core.xsd
Special Characters: *n/a*
Maximum Length: 32
Maximum Occurrences: 1
Regular Expression: *n/a*
Namespace: <http://niem.gov/niem/niem-core/2.0>

XPath

```
/itl:PackageDescriptiveTextRecord
├── /itl:UserDefinedDescriptiveDetail
│   ├── /itl:DomainDefinedDescriptiveDetail
│   │   ├── /int-i:RecordMetadata
│   │   │   ├── /int-i:MiscellaneousIdentification
│   │   │   │   ├── /int-i:MiscellaneousIdentificationID5
│   │   │   │   └── /nc:IdentificationID
```

Summary

Value of the miscellaneous identifier

Valid Examples

```
<nc:IdentificationID>MISC5</nc:IdentificationID>
```

9.42. Date (and Time) Fingerprinted - DPR

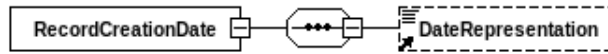

Field Reference: 2/DPR:X
Content Type: Data_X
XML Tag Name: RecordCreationDate
Data Type: ANS
Minimum Length: 10
Minimum Occurrences: 0
Value range: *n/a*
Code table: *n/a*
Base type: [niem-xsd:date](#) or [niem-xsd:dateTime](#)

Field ID: [02.019:X]
Condition: Optional
Defined in: [xsd/niem/biometrics/1.0/biometrics.xsd](#)
Special Characters: [-:]
Maximum Length: *
Maximum Occurrences: 1
Regular Expression: `\d{4}-\d{2}-\d{2}(T\d{2}:\d{2}:\d{2}(Z){0,1}){0,1}`
Namespace: <http://niem.gov/niem/biometrics/1.0>

XPath

```

/itl:PackageDescriptiveTextRecord
  ↳/itl:UserDefinedDescriptiveDetail
    ↳/itl:DomainDefinedDescriptiveDetail
      ↳/int-i:RecordActivity
        ↳/biom:RecordCreationDate
          ↳/nc:DateTime
or
/itl:PackageDescriptiveTextRecord
  ↳/itl:UserDefinedDescriptiveDetail
    ↳/itl:DomainDefinedDescriptiveDetail
      ↳/int-i:RecordActivity
        ↳/biom:RecordCreationDate
          ↳/nc:Date

```

Summary

Date (and Time), in ISO 8601 format, on which the images were acquired.

Notes

This is the date when the images have been acquired, independently from the date when the record has been created.

Note that it is now possible to put the date of the acquisition directly in the Type 14 and Type 15.

Valid Examples

```

<biom:RecordCreationDate>
  <nc:DateTime>2010-07-04T15:05:12Z</nc:DateTime>
</biom:RecordCreationDate>
or
<biom:RecordCreationDate>
  <nc:Date>2010-07-04</nc:Date>
</biom:RecordCreationDate>

```

9.43. Offence Description Code - RFP

 OffenceDescriptionCode
--

Field Reference: 2/RFP
Content Type: Data_X
XML Tag Name: OffenceDescriptionCode
Data Type: A
Minimum Length: 2
Minimum Occurrences: 0
Value range: *n/a*
Code table: see table [A.40](#)
Base type: int-i:OffenceDescriptionCodeType

Field ID: [02.021]
Condition: Optional
Defined in: xsd/int-i/1.0/int-i.xsd
Special Characters: *n/a*
Maximum Length: 3
Maximum Occurrences: 1
Regular Expression: *n/a*
Namespace: <http://interpol.int/int-i/1.0>

XPath

```
/itl:PackageDescriptiveTextRecord  
  ↳/itl:UserDefinedDescriptiveDetail  
    ↳/itl:DomainDefinedDescriptiveDetail  
      ↳/int-i:RecordOffence  
        ↳/int-i:OffenceDescriptionCode
```

Summary

Reason for acquiring the fingerprints (Criminal acquisition)

Valid Examples

<code><int-i:OffenceDescriptionCode>NLC</int-i:OffenceDescriptionCode></code>

9.44. Place Of Arrest - POA

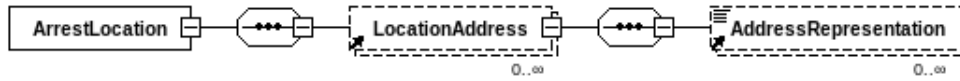

Field Reference: 2/POA:X

Content Type: Set_X

XML Tag Name: ArrestLocation

Data Type:

Minimum Length:

Minimum Occurrences: 0

Value range: *n/a*

Code table: *n/a*

Base type: nc:LocationType

Field ID: [02.022:X]

Condition: Optional

Defined in: xsd/int-i/1.0/int-i.xsd

Special Characters: *n/a*

Maximum Length:

Maximum Occurrences: 1

Regular Expression: *n/a*

Namespace: <http://interpol.int/int-i/1.0>

XPath

```

/itl:PackageDescriptiveTextRecord
  ↳/itl:UserDefinedDescriptiveDetail
    ↳/itl:DomainDefinedDescriptiveDetail
      ↳/int-i:RecordOffence
        ↳/int-i:ArrestLocation
  
```

Summary

Description of the place of arrest.

Valid Examples

```

<int-i:ArrestLocation>
  <nc:LocationAddress>
    <nc:StructuredAddress>
      <nc:LocationCityName>Wiesbaden</nc:LocationCityName>
      <nc:LocationCountyName>Hessen</nc:LocationCountyName>
      <nc:LocationCountryISO3166Alpha3Code>DEU</nc:LocationCountryISO3166Alpha3Code>
    </nc:StructuredAddress>
  </nc:LocationAddress>
</int-i:ArrestLocation>
or
<int-i:ArrestLocation>
  <nc:LocationAddress>
    <nc:AddressFullText>Wiesbaden</nc:AddressFullText>
  </nc:LocationAddress>
</int-i:ArrestLocation>
  
```

9.45. Place of Arrest (XML) – Free-text-form address - POA

AddressFullText

Field Reference: 2/POA/POA:X1
Content Type: Data_X
XML Tag Name: AddressFullText
Data Type: U
Minimum Length: 1
Minimum Occurrences: 0
Value range: *n/a*
Code table: *n/a*
Base type: nc:TextType

Field ID: [02.022:X1]
Condition: Dependent (see table)
Defined in: xsd/niem/niem-core/2.0/niem-core.xsd
Special Characters: [,-]
Maximum Length: *
Maximum Occurrences: 1
Regular Expression: *n/a*
Namespace: <http://niem.gov/niem/niem-core/2.0>

Dependency table

Type of dependency	Value
Mandatory on Absence of other Field	[2/POA/POA:X2]

XPath

```

/itl:PackageDescriptiveTextRecord
├── /itl:UserDefinedDescriptiveDetail
│   ├── /itl:DomainDefinedDescriptiveDetail
│   │   ├── /int-i:RecordOffence
│   │   │   ├── /int-i:ArrestLocation
│   │   │   │   ├── /nc:LocationAddress
│   │   │   │   │   └── /nc:AddressFullText
  
```

Summary

Place of arrest of the subject being fingerprinted, in free text format.

Valid Examples

```

<nc:AddressFullText>
  Thaerstrasse 11,
  Wiesbaden 65173
  Deutschland
</nc:AddressFullText>
  
```

9.46. Place of Arrest (XML) – Structured-form address - POA

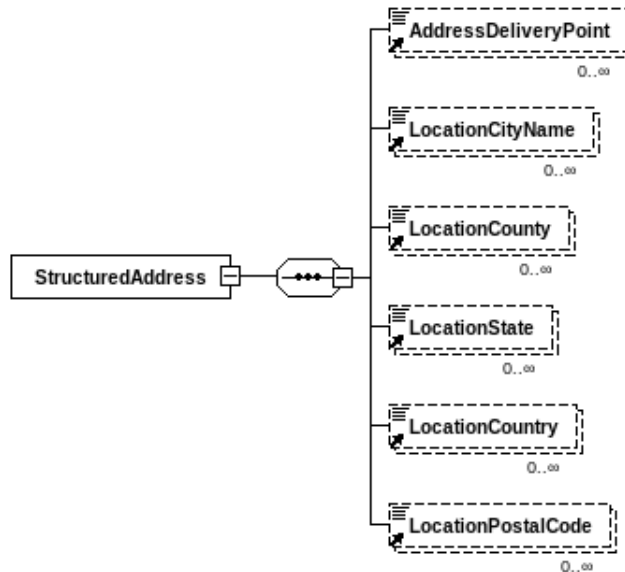

Field Reference: 2/POA/POA:X2
Content Type: Set_X
XML Tag Name: StructuredAddress
Data Type:
Minimum Length:
Minimum Occurrences: 0
Value range: *n/a*
Code table: *n/a*
Base type: nc:StructuredAddressType

Field ID: [02.022:X2-A_02.022:X2-G]
Condition: Dependent (see table)
Defined in: xsd/niem/niem-core/2.0/niem-core.xsd
Special Characters: *n/a*
Maximum Length:
Maximum Occurrences: 1
Regular Expression: *n/a*
Namespace: <http://niem.gov/niem/niem-core/2.0>

Dependency table

Type of dependency	Value
Mandatory on Absence of other Field	[2/POA/POA:X1]

XPath

```

/itl:PackageDescriptiveTextRecord
├── /itl:UserDefinedDescriptiveDetail
│   ├── /itl:DomainDefinedDescriptiveDetail
│   │   ├── /int-i:RecordOffence
│   │   │   ├── /int-i:ArrestLocation
│   │   │   │   ├── /nc:LocationAddress
│   │   │   │   └── /nc:StructuredAddress
    
```

Summary

Place of arrest of the subject being fingerprinted, in structured format.

Notes

When using a nc:StructuredAddress, at least the nc:LocationCountryISO3166Alpha3Code must be specified.

Valid Examples

```
<nc:StructuredAddress>
  <nc:LocationStreet>
    <nc:StreetNumberText>11</nc:StreetNumberText>
    <nc:StreetName>Thaerstrasse</nc:StreetName>
  </nc:LocationStreet>
  <nc:LocationCityName>Wiesbaden</nc:LocationCityName>
  <nc:LocationStateName>Hessen</nc:LocationStateName>
  <nc:LocationCountryISO3166Alpha3Code>DEU</nc:LocationCountryISO3166Alpha3Code>
  <nc:LocationPostalCode>65173</nc:LocationPostalCode>
</nc:StructuredAddress>
```

9.47. Place of Arrest (XML) – Street number - PA1

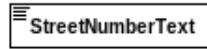

Field Reference: 2/POA/POA:X2/PB1
Content Type: Data_X
XML Tag Name: StreetNumberText
Data Type: AN
Minimum Length: 1
Minimum Occurrences: 0
Value range: *n/a*
Code table: *n/a*
Base type: nc:TextType

Field ID: [02.022:X2-A]
Condition: Optional within a field
Defined in: xsd/niem/niem-core/2.0/niem-core.xsd
Special Characters: *n/a*
Maximum Length: *
Maximum Occurrences: 1
Regular Expression: *n/a*
Namespace: <http://niem.gov/niem/niem-core/2.0>

XPath

```
/itl:PackageDescriptiveTextRecord
├── /itl:UserDefinedDescriptiveDetail
│   ├── /itl:DomainDefinedDescriptiveDetail
│   │   ├── /int-i:RecordOffence
│   │   │   ├── /int-i:ArrestLocation
│   │   │   │   ├── /nc:LocationAddress
│   │   │   │   │   ├── /nc:StructuredAddress
│   │   │   │   │   │   ├── /nc:LocationStreet
│   │   │   │   │   │   └── /nc:StreetNumberText
```

Summary

In structured format, street number of the place of arrest of the subject being fingerprinted.

9.48. Place of Arrest (XML) – Street name - PA2

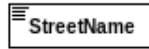
 StreetName

Field Reference: 2/POA/POA:X2/PB2
Content Type: Data_X
XML Tag Name: StreetName
Data Type: U
Minimum Length: 1
Minimum Occurrences: 0
Value range: *n/a*
Code table: *n/a*
Base type: nc:ProperNameTextType

Field ID: [02.022:X2-B]
Condition: Optional within a field
Defined in: xsd/niem/niem-core/2.0/niem-core.xsd
Special Characters: *n/a*
Maximum Length: *
Maximum Occurrences: 1
Regular Expression: *n/a*
Namespace: <http://niem.gov/niem/niem-core/2.0>

XPath

```
/itl:PackageDescriptiveTextRecord
├─ /itl:UserDefinedDescriptiveDetail
│   └─ /itl:DomainDefinedDescriptiveDetail
│       └─ /int-i:RecordOffence
│           └─ /int-i:ArrestLocation
│               └─ /nc:LocationAddress
│                   └─ /nc:StructuredAddress
│                       └─ /nc:LocationStreet
│                           └─ /nc:StreetName
```

Summary

In structured format, street name of the place of arrest of the subject being fingerprinted.

9.49. Place of Arrest (XML) – City name - PA3

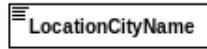

Field Reference: 2/POA/POA:X2/PB3
Content Type: Data_X
XML Tag Name: LocationCityName
Data Type: U
Minimum Length: 1
Minimum Occurrences: 0
Value range: *n/a*
Code table: *n/a*
Base type: nc:ProperNameTextType

Field ID: [02.022:X2-C]
Condition: Optional within a field
Defined in: xsd/niem/niem-core/2.0/niem-core.xsd
Special Characters: *n/a*
Maximum Length: *
Maximum Occurrences: 1
Regular Expression: *n/a*
Namespace: <http://niem.gov/niem/niem-core/2.0>

XPath

```
/itl:PackageDescriptiveTextRecord
├── /itl:UserDefinedDescriptiveDetail
│   ├── /itl:DomainDefinedDescriptiveDetail
│   │   ├── /int-i:RecordOffence
│   │   │   ├── /int-i:ArrestLocation
│   │   │   │   ├── /nc:LocationAddress
│   │   │   │   │   ├── /nc:StructuredAddress
│   │   │   │   │   └── /nc:LocationCityName
```

Summary

In structured format, city name of the place of arrest of the subject being fingerprinted.

9.50. Place of Arrest (XML) – County name - PA4

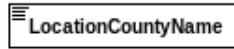

Field Reference: 2/POA/POA:X2/PB4
Content Type: Data_X
XML Tag Name: LocationCountyName
Data Type: U
Minimum Length: 1
Minimum Occurrences: 0
Value range: *n/a*
Code table: *n/a*
Base type: nc:ProperNameTextType

Field ID: [02.022:X2-D]
Condition: Optional within a field
Defined in: xsd/niem/niem-core/2.0/niem-core.xsd
Special Characters: *n/a*
Maximum Length: *
Maximum Occurrences: 1
Regular Expression: *n/a*
Namespace: <http://niem.gov/niem/niem-core/2.0>

XPath

```
/itl:PackageDescriptiveTextRecord  
  ↳/itl:UserDefinedDescriptiveDetail  
    ↳/itl:DomainDefinedDescriptiveDetail  
      ↳/int-i:RecordOffence  
        ↳/int-i:ArrestLocation  
          ↳/nc:LocationAddress  
            ↳/nc:StructuredAddress  
              ↳/nc:LocationCountyName
```

Summary

In structured format, county, parish, or vicarage name of the place of arrest of the subject being fingerprinted.

9.51. Place of Arrest (XML) – State name - PA5

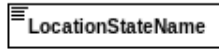

Field Reference: 2/POA/POA:X2/PB5
Content Type: Data_X
XML Tag Name: LocationStateName
Data Type: U
Minimum Length: 1
Minimum Occurrences: 0
Value range: *n/a*
Code table: *n/a*
Base type: nc:ProperNameTextType

Field ID: [02.022:X2-E]
Condition: Optional within a field
Defined in: xsd/niem/niem-core/2.0/niem-core.xsd
Special Characters: *n/a*
Maximum Length: *
Maximum Occurrences: 1
Regular Expression: *n/a*
Namespace: <http://niem.gov/niem/niem-core/2.0>

XPath

```
/itl:PackageDescriptiveTextRecord
├── /itl:UserDefinedDescriptiveDetail
│   ├── /itl:DomainDefinedDescriptiveDetail
│   │   ├── /int-i:RecordOffence
│   │   │   ├── /int-i:ArrestLocation
│   │   │   │   ├── /nc:LocationAddress
│   │   │   │   │   ├── /nc:StructuredAddress
│   │   │   │   │   └── /nc:LocationStateName
```

Summary

In structured format, state name of the place of arrest of the subject being fingerprinted.

9.52. Place of Arrest (XML) – Country code - PA6

LocationCountryISO3166Alpha3Code

Field Reference: 2/POA/POA:X2/PB6

Content Type: Data_X

XML Tag Name: LocationCountryISO3166Alpha3Code

Data Type: U

Minimum Length: 1

Minimum Occurrences: 1

Value range: *n/a*

Code table: *n/a*

Base type: [iso_3166:CountryAlpha3CodeType](#)

Field ID: [02.022:X2-F]

Condition: Mandatory within a field

Defined in: [xsd/niem/niem-core/2.0/niem-core.xsd](#)

Special Characters: *n/a*

Maximum Length: *

Maximum Occurrences: 1

Regular Expression: *n/a*

Namespace: <http://niem.gov/niem/niem-core/2.0>

XPath

```
/itl:PackageDescriptiveTextRecord
├── /itl:UserDefinedDescriptiveDetail
│   ├── /itl:DomainDefinedDescriptiveDetail
│   │   ├── /int-i:RecordOffence
│   │   │   ├── /int-i:ArrestLocation
│   │   │   │   ├── /nc:LocationAddress
│   │   │   │   │   ├── /nc:StructuredAddress
│   │   │   │   │   └── /nc:LocationCountryISO3166Alpha3Code
```

Summary

In structured format, country code in ISO3166 Alpha-3 format of the place of arrest of the subject being fingerprinted.

9.53. Place of Arrest (XML) – Postal code - PA7

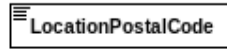

Field Reference: 2/POA/POA:X2/PB7
Content Type: Data_X
XML Tag Name: LocationPostalCode
Data Type: U
Minimum Length: 1
Minimum Occurrences: 0
Value range: *n/a*
Code table: *n/a*
Base type: niem-xsd:string

Field ID: [02.022:X2-G]
Condition: Optional within a field
Defined in: xsd/niem/niem-core/2.0/niem-core.xsd
Special Characters: *n/a*
Maximum Length: *
Maximum Occurrences: 1
Regular Expression: *n/a*
Namespace: <http://niem.gov/niem/niem-core/2.0>

XPath

```
/itl:PackageDescriptiveTextRecord
├── /itl:UserDefinedDescriptiveDetail
│   ├── /itl:DomainDefinedDescriptiveDetail
│   │   ├── /int-i:RecordOffence
│   │   │   ├── /int-i:ArrestLocation
│   │   │   │   ├── /nc:LocationAddress
│   │   │   │   │   ├── /nc:StructuredAddress
│   │   │   │   │   └── /nc:LocationPostalCode
```

Summary

In structured format, postal or ZIP code of the place of arrest of the subject being fingerprinted.

9.54. Capture Organization Information (XML) - OBU

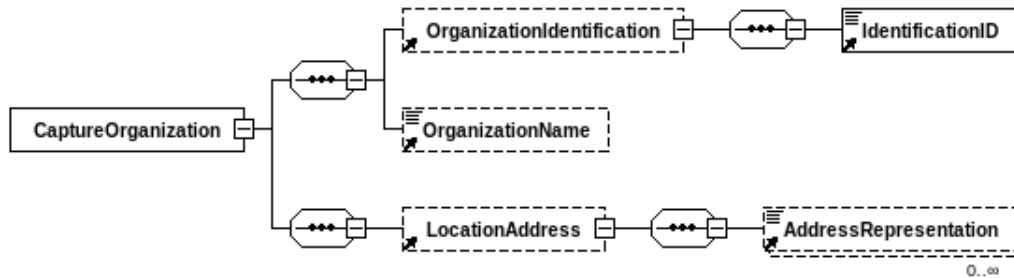

Field Reference: 2/OBU:X
Content Type: Set_X
XML Tag Name: CaptureOrganization
Data Type:
Minimum Length:
Minimum Occurrences: 0
Value range: *n/a*
Code table: *n/a*
Base type: int-i:CaptureOrganizationType

Field ID: [02.023:X]
Condition: Optional
Defined in: xsd/int-i/1.0/int-i.xsd
Special Characters: *n/a*
Maximum Length:
Maximum Occurrences: 1
Regular Expression: *n/a*
Namespace: <http://interpol.int/int-i/1.0>

XPath

```

/itl:PackageDescriptiveTextRecord
├─ /itl:UserDefinedDescriptiveDetail
│   └─ /itl:DomainDefinedDescriptiveDetail
│       └─ /int-i:RecordActivity
│           └─ /int-i:CaptureOrganization
  
```

Summary

Description of the agency that performed the fingerprint acquisition

Valid Examples

```

<int-i:CaptureOrganization>
  <nc:OrganizationName>BKA</nc:OrganizationName>
  <nc:LocationAddress>
    <nc:StructuredAddress>
      <nc:LocationStreet>
        <nc:StreetNumberText>11</nc:StreetNumberText>
        <nc:StreetName>Thaerstrasse</nc:StreetName>
      </nc:LocationStreet>
      <nc:LocationCityName>Wiesbaden</nc:LocationCityName>
      <nc:LocationCountryISO3166Alpha3Code>DEU</nc:LocationCountryISO3166Alpha3Code>
    </nc:StructuredAddress>
  </nc:LocationAddress>
</int-i:CaptureOrganization>
  
```

9.55. Capture Organization Information (XML) – Organization Identification - OB1

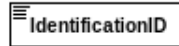

Field Reference: 2/OBU/OBU:X1
Content Type: Data_X
XML Tag Name: IdentificationID
Data Type: U
Minimum Length: 1
Minimum Occurrences: 0
Value range: *n/a*
Code table: *n/a*
Base type: niem-xsd:string

Field ID: [02.023:X1]
Condition: Optional within a field
Defined in: xsd/niem/niem-core/2.0/niem-core.xsd
Special Characters: *n/a*
Maximum Length: *
Maximum Occurrences: 1
Regular Expression: *n/a*
Namespace: <http://niem.gov/niem/niem-core/2.0>

XPath

```
/itl:PackageDescriptiveTextRecord  
  ↳/itl:UserDefinedDescriptiveDetail  
    ↳/itl:DomainDefinedDescriptiveDetail  
      ↳/int-i:RecordActivity  
        ↳/int-i:CaptureOrganization  
          ↳/nc:OrganizationIdentification  
            ↳/nc:IdentificationID
```

Summary

Organization ID of the agency that performed the fingerprint acquisition

Valid Examples

```
<nc:IdentificationID>BKA_TestSystem</nc:IdentificationID>
```

9.56. Capture Organization Information (XML) – Organization Name - OB2

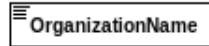

Field Reference: 2/OBU/OBU:X2
Content Type: Data_X
XML Tag Name: OrganizationName
Data Type: U
Minimum Length: 1
Minimum Occurrences: 0
Value range: *n/a*
Code table: *n/a*
Base type: nc:TextType

Field ID: [02.023:X2]
Condition: Optional within a field
Defined in: xsd/niem/niem-core/2.0/niem-core.xsd
Special Characters: [,-]
Maximum Length: *
Maximum Occurrences: 1
Regular Expression: *n/a*

Namespace: <http://niem.gov/niem/niem-core/2.0>

XPath

```
/itl:PackageDescriptiveTextRecord
  ↳/itl:UserDefinedDescriptiveDetail
    ↳/itl:DomainDefinedDescriptiveDetail
      ↳/int-i:RecordActivity
        ↳/int-i:CaptureOrganization
          ↳/nc:OrganizationName
```

Summary

Organization name of the agency that performed the fingerprint acquisition

Valid Examples

```
<nc:OrganizationName>BKA</nc:OrganizationName>
```

9.57. Capture Organization Information (XML) – Free-text-form address - OB3



Field Reference: 2/OBU/OBU:X3
Content Type: Data_X
XML Tag Name: AddressFullText
Data Type: U
Minimum Length: 1
Minimum Occurrences: 0
Value range: *n/a*
Code table: *n/a*
Base type: nc:TextType

Field ID: [02.023:X3]
Condition: Optional within a field
Defined in: xsd/niem/niem-core/2.0/niem-core.xsd
Special Characters: [,-]
Maximum Length: *
Maximum Occurrences: 1
Regular Expression: *n/a*
Namespace: <http://niem.gov/niem/niem-core/2.0>

XPath

```
/itl:PackageDescriptiveTextRecord  
  ↳/itl:UserDefinedDescriptiveDetail  
    ↳/itl:DomainDefinedDescriptiveDetail  
      ↳/int-i:RecordActivity  
        ↳/int-i:CaptureOrganization  
          ↳/nc:LocationAddress  
            ↳/nc:AddressFullText
```

Summary

Address, in free text format, of the agency that performed the fingerprint acquisition

Valid Examples

```
<nc:AddressFullText>Thaerstrasse 11, Wiesbaden, Deutschland</nc:AddressFullText>
```

9.58. Capture Organization Information (XML) – Structured-form address - OB4

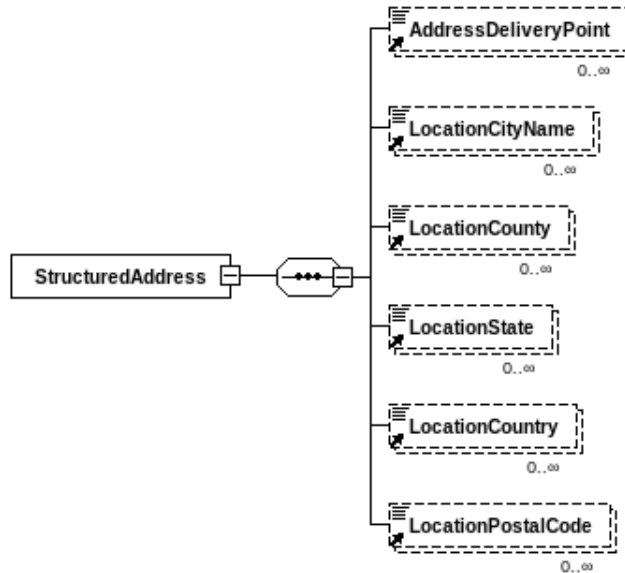

Field Reference: 2/OBU/OBU:X4
Content Type: Set_X
XML Tag Name: StructuredAddress
Data Type:
Minimum Length:
Minimum Occurrences: 0
Value range: *n/a*
Code table: *n/a*
Base type: nc:StructuredAddressType

Field ID: [02.023:X3-A_02.023:X3-G]
Condition: Optional within a field
Defined in: xsd/niem/niem-core/2.0/niem-core.xsd
Special Characters: *n/a*
Maximum Length:
Maximum Occurrences: 1
Regular Expression: *n/a*
Namespace: <http://niem.gov/niem/niem-core/2.0>

XPath

```

/itl:PackageDescriptiveTextRecord
  ↳/itl:UserDefinedDescriptiveDetail
    ↳/itl:DomainDefinedDescriptiveDetail
      ↳/int-i:RecordActivity
        ↳/int-i:CaptureOrganization
          ↳/nc:LocationAddress
            ↳/nc:StructuredAddress
    
```

Summary

Address, in structured format, of the agency that performed the fingerprint acquisition

9.59. Capture Organization Information (XML) – Street number - OB5

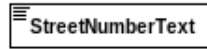

Field Reference: 2/OBU/OBU:X4/OB1
Content Type: Data_X
XML Tag Name: StreetNumberText
Data Type: AN
Minimum Length: 1
Minimum Occurrences: 0
Value range: *n/a*
Code table: *n/a*
Base type: nc:TextType

Field ID: [02.023:X3-A]
Condition: Optional within a field
Defined in: xsd/niem/niem-core/2.0/niem-core.xsd
Special Characters: *n/a*
Maximum Length: *
Maximum Occurrences: 1
Regular Expression: *n/a*
Namespace: <http://niem.gov/niem/niem-core/2.0>

XPath

```
/itl:PackageDescriptiveTextRecord
├── /itl:UserDefinedDescriptiveDetail
│   ├── /itl:DomainDefinedDescriptiveDetail
│   │   ├── /int-i:RecordActivity
│   │   │   ├── /int-i:CaptureOrganization
│   │   │   │   ├── /nc:LocationAddress
│   │   │   │   │   ├── /nc:StructuredAddress
│   │   │   │   │   │   ├── /nc:LocationStreet
│   │   │   │   │   │   │   └── /nc:StreetNumberText
```

Summary

In structured format, street number of the agency that performed the fingerprint acquisition.

9.60. Capture Organization Information (XML) – Street name - OB6

StreetName

Field Reference: 2/OBU/OBU:X4/OB2
Content Type: Data_X
XML Tag Name: StreetName
Data Type: U
Minimum Length: 1
Minimum Occurrences: 0
Value range: *n/a*
Code table: *n/a*
Base type: nc:ProperNameTextType

Field ID: [02.023:X3-B]
Condition: Optional within a field
Defined in: xsd/niem/niem-core/2.0/niem-core.xsd
Special Characters: *n/a*
Maximum Length: *
Maximum Occurrences: 1
Regular Expression: *n/a*
Namespace: <http://niem.gov/niem/niem-core/2.0>

XPath

```
/itl:PackageDescriptiveTextRecord
├── /itl:UserDefinedDescriptiveDetail
│   ├── /itl:DomainDefinedDescriptiveDetail
│   │   ├── /int-i:RecordActivity
│   │   │   ├── /int-i:CaptureOrganization
│   │   │   │   ├── /nc:LocationAddress
│   │   │   │   │   ├── /nc:StructuredAddress
│   │   │   │   │   │   ├── /nc:LocationStreet
│   │   │   │   │   │   │   └── /nc:StreetName
```

Summary

In structured format, street name of the agency that performed the fingerprint acquisition.

9.61. Capture Organization Information (XML) – City name - OB7

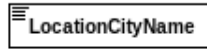

Field Reference: 2/OBU/OBU:X4/OB3
Content Type: Data_X
XML Tag Name: LocationCityName
Data Type: U
Minimum Length: 1
Minimum Occurrences: 0
Value range: *n/a*
Code table: *n/a*
Base type: nc:ProperNameTextType

Field ID: [02.023:X3-C]
Condition: Optional within a field
Defined in: xsd/niem/niem-core/2.0/niem-core.xsd
Special Characters: *n/a*
Maximum Length: *
Maximum Occurrences: 1
Regular Expression: *n/a*
Namespace: <http://niem.gov/niem/niem-core/2.0>

XPath

```
/itl:PackageDescriptiveTextRecord
├── /itl:UserDefinedDescriptiveDetail
│   ├── /itl:DomainDefinedDescriptiveDetail
│   │   ├── /int-i:RecordActivity
│   │   │   ├── /int-i:CaptureOrganization
│   │   │   │   ├── /nc:LocationAddress
│   │   │   │   │   ├── /nc:StructuredAddress
│   │   │   │   │   └── /nc:LocationCityName
```

Summary

In structured format, city name of the agency that performed the fingerprint acquisition.

9.62. Capture Organization Information (XML) – County name - OB8

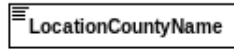

Field Reference: 2/OBU/OBU:X4/OB4
Content Type: Data_X
XML Tag Name: LocationCountyName
Data Type: U
Minimum Length: 1
Minimum Occurrences: 0
Value range: *n/a*
Code table: *n/a*
Base type: nc:ProperNameTextType

Field ID: [02.023:X3-D]
Condition: Optional within a field
Defined in: xsd/niem/niem-core/2.0/niem-core.xsd
Special Characters: *n/a*
Maximum Length: *
Maximum Occurrences: 1
Regular Expression: *n/a*
Namespace: <http://niem.gov/niem/niem-core/2.0>

XPath

```
/itl:PackageDescriptiveTextRecord
├── /itl:UserDefinedDescriptiveDetail
│   ├── /itl:DomainDefinedDescriptiveDetail
│   │   ├── /int-i:RecordActivity
│   │   │   ├── /int-i:CaptureOrganization
│   │   │   │   ├── /nc:LocationAddress
│   │   │   │   │   ├── /nc:StructuredAddress
│   │   │   │   │   └── /nc:LocationCountyName
```

Summary

In structured format, county, parish, or vicarage name of the agency that performed the fingerprint acquisition.

9.63. Capture Organization Information (XML) – State name - OB9

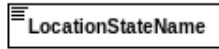

Field Reference: 2/OBU/OBU:X4/OB5
Content Type: Data_X
XML Tag Name: LocationStateName
Data Type: U
Minimum Length: 1
Minimum Occurrences: 0
Value range: *n/a*
Code table: *n/a*
Base type: nc:ProperNameTextType

Field ID: [02.023:X3-E]
Condition: Optional within a field
Defined in: xsd/niem/niem-core/2.0/niem-core.xsd
Special Characters: *n/a*
Maximum Length: *
Maximum Occurrences: 1
Regular Expression: *n/a*
Namespace: <http://niem.gov/niem/niem-core/2.0>

XPath

```
/itl:PackageDescriptiveTextRecord
├── /itl:UserDefinedDescriptiveDetail
│   ├── /itl:DomainDefinedDescriptiveDetail
│   │   ├── /int-i:RecordActivity
│   │   │   ├── /int-i:CaptureOrganization
│   │   │   │   ├── /nc:LocationAddress
│   │   │   │   │   ├── /nc:StructuredAddress
│   │   │   │   │   └── /nc:LocationStateName
```

Summary

In structured format, state name of the agency that performed the fingerprint acquisition.

9.64. Capture Organization Information (XML) – Country code - OB10

LocationCountryISO3166Alpha3Code

Field Reference: 2/OBU/OBU:X4/OB6

Content Type: Data_X

XML Tag Name: LocationCountryISO3166Alpha3Code

Data Type: U

Minimum Length: 1

Minimum Occurrences: 0

Value range: *n/a*

Code table: *n/a*

Base type: [iso_3166:CountryAlpha3CodeType](#)

Field ID: [02.023:X3-F]

Condition: Optional within a field

Defined in: [xsd/niem/niem-core/2.0/niem-core.xsd](#)

Special Characters: *n/a*

Maximum Length: *

Maximum Occurrences: 1

Regular Expression: *n/a*

Namespace: <http://niem.gov/niem/niem-core/2.0>

XPath

```
/itl:PackageDescriptiveTextRecord
├── /itl:UserDefinedDescriptiveDetail
│   ├── /itl:DomainDefinedDescriptiveDetail
│   │   ├── /int-i:RecordActivity
│   │   │   ├── /int-i:CaptureOrganization
│   │   │   │   ├── /nc:LocationAddress
│   │   │   │   │   ├── /nc:StructuredAddress
│   │   │   │   │   └── /nc:LocationCountryISO3166Alpha3Code
```

Summary

In structured format, country code in ISO3166 Alpha-3 format of the agency that performed the fingerprint acquisition.

9.65. Capture Organization Information (XML) – Postal code - OB11

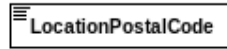

Field Reference: 2/OBU/OBU:X4/OB7
Content Type: Data_X
XML Tag Name: LocationPostalCode
Data Type: U
Minimum Length: 1
Minimum Occurrences: 0
Value range: *n/a*
Code table: *n/a*
Base type: niem-xsd:string

Field ID: [02.023:X3-G]
Condition: Optional within a field
Defined in: xsd/niem/niem-core/2.0/niem-core.xsd
Special Characters: *n/a*
Maximum Length: *
Maximum Occurrences: 1
Regular Expression: *n/a*
Namespace: <http://niem.gov/niem/niem-core/2.0>

XPath

```
/itl:PackageDescriptiveTextRecord
├── /itl:UserDefinedDescriptiveDetail
│   ├── /itl:DomainDefinedDescriptiveDetail
│   │   ├── /int-i:RecordActivity
│   │   │   ├── /int-i:CaptureOrganization
│   │   │   │   ├── /nc:LocationAddress
│   │   │   │   │   ├── /nc:StructuredAddress
│   │   │   │   │   └── /nc:LocationPostalCode
```

Summary

In structured format, postal or ZIP code of the agency that performed the fingerprint acquisition.

9.66. Name - NAM

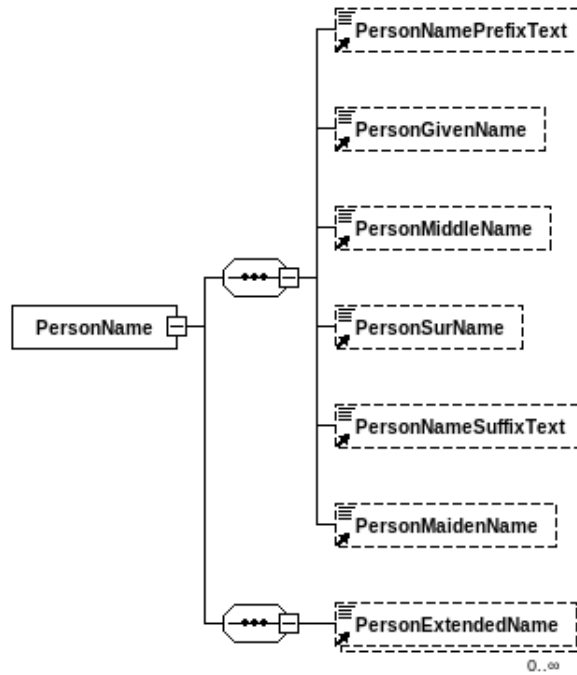

Field Reference: 2/NAM:X
Content Type: Set_X
XML Tag Name: PersonName
Data Type:
Minimum Length:
Minimum Occurrences: 0
Value range: *n/a*
Code table: *n/a*
Base type: int-i:PersonNameType

Field ID: [02.030]
Condition: Dependent (see table)
Defined in: xsd/int-i/1.0/int-i.xsd
Special Characters: *n/a*
Maximum Length:
Maximum Occurrences: 1
Regular Expression: *n/a*
Namespace: <http://interpol.int/int-i/1.0>

Dependency table

Type of dependency	Value
Mandatory on Value of other Field, optional otherwise.	[1/TOT]="ATP"

XPath

```

/itl:PackageDescriptiveTextRecord
├── /itl:UserDefinedDescriptiveDetail
│   ├── /itl:DomainDefinedDescriptiveDetail
│   │   ├── /int-i:RecordSubject
│   │   └── /int-i:PersonName
    
```

Summary

Name of the subject being fingerprinted

Valid Examples

```
<int-i:PersonName>  
  <nc:PersonNamePrefixText>Dr</nc:PersonNamePrefixText>  
  <nc:PersonGivenName>Renate</nc:PersonGivenName>  
  <nc:PersonMiddleName>Erika</nc:PersonMiddleName>  
  <nc:PersonSurName>Mustermann</nc:PersonSurName>  
  <nc:PersonNameSuffixText>Jr</nc:PersonNameSuffixText>  
  <nc:PersonMaidenName>Schmidt</nc:PersonMaidenName>  
  <int-i:PersonExtendedName>Dr. Renate Erika Mustermann</int-i:PersonExtendedName>  
</int-i:PersonName>
```

9.67. Person Prefix Name - NM1

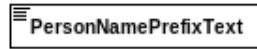

Field Reference: 2/NAM/NAM:X1
Content Type: Data_X
XML Tag Name: PersonNamePrefixText
Data Type: U
Minimum Length: 1
Minimum Occurrences: 0
Value range: *n/a*
Code table: *n/a*
Base type: nc:TextType

Field ID: [02.030:X1]
Condition: Optional within a field
Defined in: xsd/niem/niem-core/2.0/niem-core.xsd
Special Characters: *n/a*
Maximum Length: *
Maximum Occurrences: 1
Regular Expression: *n/a*

Namespace: <http://niem.gov/niem/niem-core/2.0>

XPath

```
/it1:PackageDescriptiveTextRecord  
  ↳/it1:UserDefinedDescriptiveDetail  
    ↳/it1:DomainDefinedDescriptiveDetail  
      ↳/int-i:RecordSubject  
        ↳/int-i:PersonName  
          ↳/nc:PersonNamePrefixText
```

Summary

Title or honorific of the subject being fingerprinted, for instance Dr.

Notes

Even though multiple nc:PersonNamePrefixText are allowed by the xsd, INTERPOL's implementation expects only one.

Valid Examples

```
<nc:PersonNamePrefixText>Dr</nc:PersonNamePrefixText>
```

9.68. Person Given Name - NM2

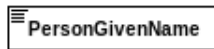

Field Reference: 2/NAM/NAM:X2
Content Type: Data_X
XML Tag Name: PersonGivenName
Data Type: U
Minimum Length: 1
Minimum Occurrences: 0
Value range: *n/a*
Code table: *n/a*
Base type: nc:PersonNameTextType

Field ID: [02.030:X2]
Condition: Dependent (see table)
Defined in: xsd/niem/niem-core/2.0/niem-core.xsd
Special Characters: *n/a*
Maximum Length: *
Maximum Occurrences: 1
Regular Expression: *n/a*
Namespace: <http://niem.gov/niem/niem-core/2.0>

Dependency table

Type of dependency	Value
Mandatory on Absence of other Field	[2/NAM/NAM:X7]

XPath

```

/itl:PackageDescriptiveTextRecord
  ↳/itl:UserDefinedDescriptiveDetail
    ↳/itl:DomainDefinedDescriptiveDetail
      ↳/int-i:RecordSubject
        ↳/int-i:PersonName
          ↳/nc:PersonGivenName
  
```

Summary

Given name of the subject being fingerprinted

Notes

Even though multiple nc:PersonGivenName are allowed by the xsd, INTERPOL's implementation expects only one.

Valid Examples

```
<nc:PersonGivenName>Renate</nc:PersonGivenName>
```

9.69. Person Middle Name - NM3



Field Reference: 2/NAM/NAM:X3
Content Type: Data_X
XML Tag Name: PersonMiddleName
Data Type: U
Minimum Length: 1
Minimum Occurrences: 0
Value range: *n/a*
Code table: *n/a*
Base type: nc:PersonNameTextType

Field ID: [02.030:X3]
Condition: Optional within a field
Defined in: xsd/niem/niem-core/2.0/niem-core.xsd
Special Characters: *n/a*
Maximum Length: *
Maximum Occurrences: 1
Regular Expression: *n/a*
Namespace: <http://niem.gov/niem/niem-core/2.0>

XPath

```
/it1:PackageDescriptiveTextRecord  
  ↳/it1:UserDefinedDescriptiveDetail  
    ↳/it1:DomainDefinedDescriptiveDetail  
      ↳/int-i:RecordSubject  
        ↳/int-i:PersonName  
          ↳/nc:PersonMiddleName
```

Summary

Middle name of the subject being fingerprinted

Notes

Even though multiple nc:PersonMiddleName are allowed by the xsd, INTERPOL's implementation expects only one.

Valid Examples

```
<nc:PersonMiddleName>Erika</nc:PersonMiddleName>
```

9.70. Person Surname - NM4

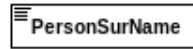

Field Reference: 2/NAM/NAM:X4
Content Type: Data_X
XML Tag Name: PersonSurName
Data Type: U
Minimum Length: 1
Minimum Occurrences: 0
Value range: *n/a*
Code table: *n/a*
Base type: nc:PersonNameTextType

Field ID: [02.030:X4]
Condition: Dependent (see table)
Defined in: xsd/niem/niem-core/2.0/niem-core.xsd
Special Characters: *n/a*
Maximum Length: *
Maximum Occurrences: 1
Regular Expression: *n/a*
Namespace: <http://niem.gov/niem/niem-core/2.0>

Dependency table

Type of dependency	Value
Mandatory on Absence of other Field	[2/NAM/NAM:X7]

XPath

```

/itl:PackageDescriptiveTextRecord
  ↳/itl:UserDefinedDescriptiveDetail
    ↳/itl:DomainDefinedDescriptiveDetail
      ↳/int-i:RecordSubject
        ↳/int-i:PersonName
          ↳/nc:PersonSurName
  
```

Summary

Surname of the subject being fingerprinted.

Notes

Even though multiple nc:PersonSurName are allowed by the xsd, INTERPOL's implementation expects only one.

Valid Examples

```
>nc:PersonSurName>Mustermann</nc:PersonSurName>
```

9.71. Person Suffix Name - NM5

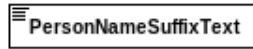

Field Reference: 2/NAM/NAM:X5
Content Type: Data_X
XML Tag Name: PersonNameSuffixText
Data Type: U
Minimum Length: 1
Minimum Occurrences: 0
Value range: *n/a*
Code table: *n/a*
Base type: nc:TextType

Field ID: [02.030:X5]
Condition: Optional within a field
Defined in: xsd/niem/niem-core/2.0/niem-core.xsd
Special Characters: *n/a*
Maximum Length: *
Maximum Occurrences: 1
Regular Expression: *n/a*

Namespace: <http://niem.gov/niem/niem-core/2.0>

XPath

```
/itl:PackageDescriptiveTextRecord  
  ↳/itl:UserDefinedDescriptiveDetail  
    ↳/itl:DomainDefinedDescriptiveDetail  
      ↳/int-i:RecordSubject  
        ↳/int-i:PersonName  
          ↳/nc:PersonNameSuffixText
```

Summary

Suffix of the subject being fingerprinted.

Notes

Even though multiple nc:PersonNameSuffixText are allowed by the xsd, INTERPOL's implementation expects only one.

Valid Examples

```
<nc:PersonNameSuffixText>Jr.</nc:PersonNameSuffixText>
```

9.72. Person Maiden Name - NM6



Field Reference: 2/NAM/NAM:X6
Content Type: Data_X
XML Tag Name: PersonMaidenName
Data Type: U
Minimum Length: 1
Minimum Occurrences: 0
Value range: *n/a*
Code table: *n/a*
Base type: nc:PersonNameTextType

Field ID: [02.030:X6]
Condition: Optional within a field
Defined in: xsd/niem/niem-core/2.0/niem-core.xsd
Special Characters: *n/a*
Maximum Length: *
Maximum Occurrences: 1
Regular Expression: *n/a*
Namespace: <http://niem.gov/niem/niem-core/2.0>

XPath

```
/itl:PackageDescriptiveTextRecord  
  ↳/itl:UserDefinedDescriptiveDetail  
    ↳/itl:DomainDefinedDescriptiveDetail  
      ↳/int-i:RecordSubject  
        ↳/int-i:PersonName  
          ↳/nc:PersonMaidenName
```

Summary

Maiden name of the subject being fingerprinted.

Notes

Even though multiple nc:PersonMaidenName are allowed by the xsd, INTERPOL's implementation expects only one.

Valid Examples

```
<nc:PersonMaidenName>Schmidt</nc:PersonMaidenName>
```

9.73. Person Extended Name - NM7

PersonExtendedName

Field Reference: 2/NAM/NAM:X7
Content Type: Data_X
XML Tag Name: PersonExtendedName
Data Type: U
Minimum Length: 1
Minimum Occurrences: 0
Value range: *n/a*
Code table: *n/a*
Base type: nc:TextType

Field ID: [02.030:X7]
Condition: Dependent (see table)
Defined in: xsd/int-i/1.0/int-i.xsd
Special Characters: *n/a*
Maximum Length: *
Maximum Occurrences: 1
Regular Expression: *n/a*

Namespace: <http://interpol.int/int-i/1.0>

Dependency table

Type of dependency	Value
Mandatory on Absence of other Field	[2/NAM/NAM:X2],[2/NAM/NAM:X4]

XPath

```

/itl:PackageDescriptiveTextRecord
├─ /itl:UserDefinedDescriptiveDetail
│   └─ /itl:DomainDefinedDescriptiveDetail
│       └─ /int-i:RecordSubject
│           └─ /int-i:PersonName
│               └─ /int-i:PersonExtendedName
  
```

Summary

Extended name of the subject being fingerprinted.

Notes

Even though multiple int-i:PersonExtendedName are allowed by the xsd, INTERPOL's implementation expects only one.

The extended name is used for two different cases:

- when the local culture does not follow the first/middle/last naming convention;
- in case of record conversion, when it would be difficult to convert the full name from a single string to the XML structure.

Valid Examples

```
<int-i:PersonExtendedName>Dr. Renate Erika Mustermann</int-i:PersonExtendedName>
```

9.74. Aliases - AKA

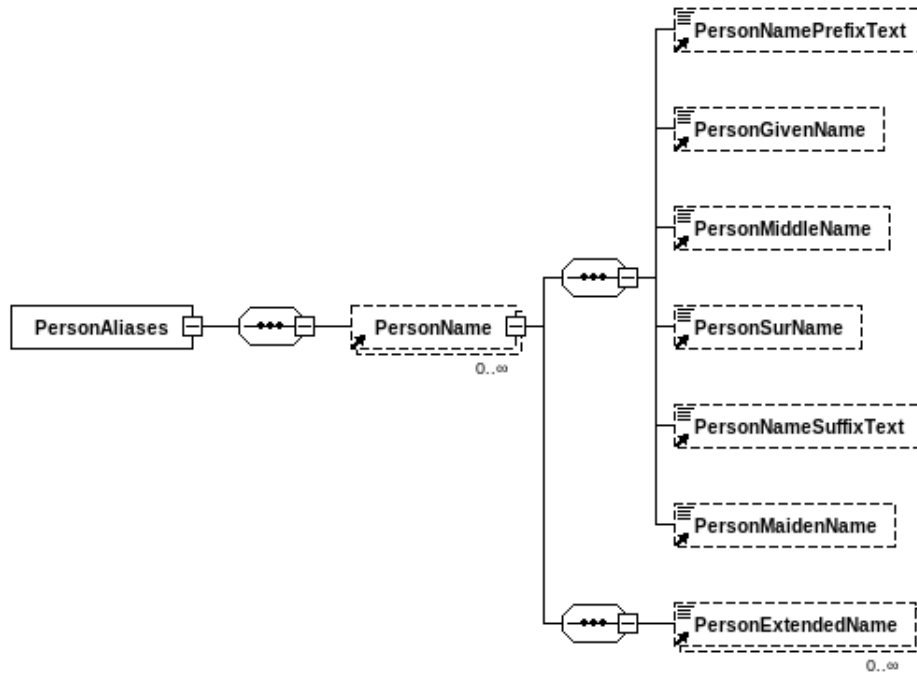

Field Reference: 2/AKA
Content Type: Set_X
XML Tag Name: PersonAliases
Data Type:
Minimum Length:
Minimum Occurrences:
Value range: *n/a*
Code table: *n/a*
Base type: int-i:PersonAliasesType

Field ID: [02.034]
Condition: Optional
Defined in: xsd/int-i/1.0/int-i.xsd
Special Characters: *n/a*
Maximum Length:
Maximum Occurrences:
Regular Expression: *n/a*
Namespace: <http://interpol.int/int-i/1.0>

XPath

```

/itl:PackageDescriptiveTextRecord
  ↳ /itl:UserDefinedDescriptiveDetail
    ↳ /itl:DomainDefinedDescriptiveDetail
      ↳ /int-i:RecordSubject
        ↳ /int-i:PersonAliases
    
```

Summary

The aliases of the subject being fingerprinted.

Notes

Each alias as the same format as the name field (9.66) with up to 7 subfields.

Valid Examples

```
<int-i:PersonAliases>  
  <int-i:PersonName>  
    <nc:PersonGivenName>Heike</nc:PersonGivenName>  
    <nc:PersonSurName>Schneider</nc:PersonSurName>  
  </int-i:PersonName>  
</int-i:PersonAliases>
```

9.75. Date of Birth (XML) - DOB



Field Reference: 2/DOB:X

Content Type: Data_X

XML Tag Name: PersonBirthDate

Data Type: NS

Minimum Length: 10

Minimum Occurrences: 0

Value range: *n/a*

Code table: *n/a*

Base type: [niem-xsd:date](#)

Field ID: [02.035:X]

Condition: Optional

Defined in: [xsd/niem/niem-core/2.0/niem-core.xsd](#)

Special Characters: [-]

Maximum Length: 10

Maximum Occurrences: 1

Regular Expression: `\d{4}-\d{2}-\d{2}`

Namespace: <http://niem.gov/niem/niem-core/2.0>

XPath

```
/itl:PackageDescriptiveTextRecord
├─ /itl:UserDefinedDescriptiveDetail
│   └─ /itl:DomainDefinedDescriptiveDetail
│       └─ /int-i:RecordSubject
│           └─ /nc:PersonBirthDate
│               └─ /nc:Date
```

Summary

Date of birth of the subject being fingerprinted.

Notes

The date format should follow the ISO 8601 standard.

Valid Examples

```
<nc:PersonBirthDate><nc:Date>1950-12-01</nc:Date></nc:PersonBirthDate>
```

9.76. Date of Birth Range (XML) - DBR

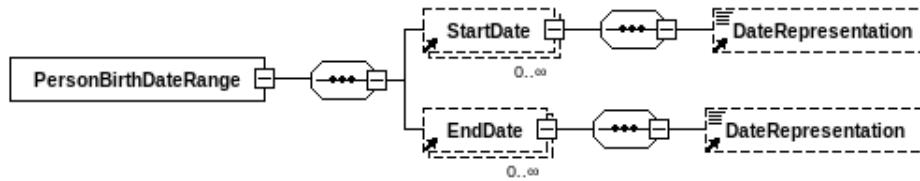

Field Reference: 2/DBR:X
Content Type: Set_X
XML Tag Name: PersonBirthDateRange
Data Type:
Minimum Length:
Minimum Occurrences: 0
Value range: *n/a*
Code table: *n/a*
Base type: nc:DateRangeType

Field ID: [02.036-A_02.036-B]
Condition: Optional
Defined in: xsd/int-i/1.0/int-i.xsd
Special Characters: *n/a*
Maximum Length:
Maximum Occurrences: 1
Regular Expression: *n/a*
Namespace: <http://interpol.int/int-i/1.0>

Dependency table

Type of dependency	Value
Mandatory on Absence of other Field	[2/DOB:X]

XPath

```

/itl:PackageDescriptiveTextRecord
├── /itl:UserDefinedDescriptiveDetail
│   ├── /itl:DomainDefinedDescriptiveDetail
│   │   ├── /int-i:RecordSubject
│   │   └── /int-i:PersonBirthDateRange
    
```

Summary

Date of birth of the subject being fingerprinted, expressed as range of date.

Notes

Either the date (DOB/2.036) or the date of birth range can be used, but not both at the same time.

Valid Examples

```

<int-i:PersonBirthDateRange>
  <nc:StartDate>
    <nc:Date>1948-01-01</nc:Date>
  </nc:StartDate>
  <nc:EndDate>
    <nc:Date>1960-12-31</nc:Date>
  </nc:EndDate>
</int-i:PersonBirthDateRange>
    
```

9.77. Date of Birth Range (XML) - Min Date - SDA

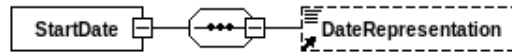

Field Reference: 2/DBR/SDA
Content Type: Data_X
XML Tag Name: StartDate
Data Type: NS
Minimum Length: 10
Minimum Occurrences: 0
Value range: *n/a*
Code table: *n/a*
Base type: [nc:DateType](#)

Field ID: [02.036-A]
Condition: Mandatory within a field
Defined in: [xsd/niem/niem-core/2.0/niem-core.xsd](#)
Special Characters: [-]
Maximum Length: 10
Maximum Occurrences: 1
Regular Expression: \d{4}-\d{2}-\d{2}
Namespace: <http://niem.gov/niem/niem-core/2.0>

XPath

```

/itl:PackageDescriptiveTextRecord
├── /itl:UserDefinedDescriptiveDetail
│   ├── /itl:DomainDefinedDescriptiveDetail
│   │   ├── /int-i:RecordSubject
│   │   │   ├── /int-i:PersonBirthDateRange
│   │   │   │   └── /nc:StartDate
    
```

Summary

Start of the date of birth range of the subject being fingerprinted.

Notes

The date format should follow the ISO 8601 standard.

Valid Examples

```

<nc:StartDate>
    <nc>Date>1948-01-01</nc>Date>
</nc:StartDate>
    
```

9.78. Date of Birth Range (XML) - Max Date - EDA

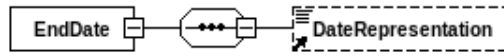

Field Reference: 2/DBR/EDA
Content Type: Data_X
XML Tag Name: EndDate
Data Type: NS
Minimum Length: 10
Minimum Occurrences: 0
Value range: *n/a*
Code table: *n/a*
Base type: [nc:DateType](#)

Field ID: [02.036-B]
Condition: Mandatory within a field
Defined in: [xsd/niem/niem-core/2.0/niem-core.xsd](#)
Special Characters: [-]
Maximum Length: 10
Maximum Occurrences: 1
Regular Expression: \d{4}-\d{2}-\d{2}
Namespace: <http://niem.gov/niem/niem-core/2.0>

XPath

```

/itl:PackageDescriptiveTextRecord
├─ /itl:UserDefinedDescriptiveDetail
│   └─ /itl:DomainDefinedDescriptiveDetail
│       └─ /int-i:RecordSubject
│           └─ /int-i:PersonBirthDateRange
│               └─ /nc:EndDate
  
```

Summary

End of the date of birth range of the subject being fingerprinted.

Notes

The date format should follow the ISO 8601 standard.

Valid Examples

```

<nc:EndDate>
    <nc:Date>1960-12-31</nc:Date>
</nc:EndDate>
  
```

9.79. Place of Birth (XML) - POB

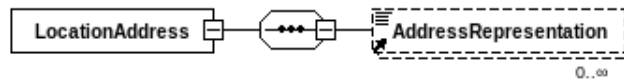

Field Reference: 2/POB:X

Content Type: Set_X

XML Tag Name: LocationAddress

Data Type:

Minimum Length:

Minimum Occurrences: 0

Value range: *n/a*

Code table: *n/a*

Base type: nc:AddressType

Field ID: [02.037:X]

Condition: Optional

Defined in: xsd/niem/niem-core/2.0/niem-core.xsd

Special Characters: *n/a*

Maximum Length:

Maximum Occurrences: 1

Regular Expression: *n/a*

Namespace: <http://niem.gov/niem/niem-core/2.0>

XPath

```
/itl:PackageDescriptiveTextRecord
  ↳/itl:UserDefinedDescriptiveDetail
    ↳/itl:DomainDefinedDescriptiveDetail
      ↳/int-i:RecordSubject
        ↳/nc:PersonBirthLocation
          ↳/nc:LocationAddress
```

Summary

Place of birth of the subject being fingerprinted. The field contains the address in a structured format or free text format.

Notes

Even though multiple location addresses can be specified according to the xsd, INTERPOL's implementation expect only one: either a StructuredAddress, or an AddressFullText, but not both.

Valid Examples

```
<nc:LocationAddress>
  <nc:StructuredAddress>
    <nc:LocationStreet>
      <nc:StreetNumberText>11</nc:StreetNumberText>
      <nc:StreetName>Thaerstrasse</nc:StreetName>
    </nc:LocationStreet>
    <nc:LocationCityName>Wiesbaden</nc:LocationCityName>
    <nc:LocationStateName>Hessen</nc:LocationStateName>
    <nc:LocationCountryISO3166Alpha3Code>DEU</nc:LocationCountryISO3166Alpha3Code>
    <nc:LocationPostalCode>65173</nc:LocationPostalCode>
  </nc:StructuredAddress>
</nc:LocationAddress>
or
<nc:LocationAddress>
  <nc:AddressFullText>
    Thaerstrasse 11,
    Wiesbaden 65173
    Deutschland
  </nc:AddressFullText>
</nc:LocationAddress>
```

Invalid Examples

```
<nc:LocationAddress>
  <nc:StructuredAddress>
    <nc:LocationStreet>
      <nc:StreetNumberText>11</nc:StreetNumberText>
      <nc:StreetName>Thaerstrasse</nc:StreetName>
    </nc:LocationStreet>
    <nc:LocationCityName>Wiesbaden</nc:LocationCityName>
    <nc:LocationStateName>Hessen</nc:LocationStateName>
    <nc:LocationCountryISO3166Alpha3Code>DEU</nc:LocationCountryISO3166Alpha3Code>
    <nc:LocationPostalCode>65173</nc:LocationPostalCode>
  </nc:StructuredAddress>
  <nc:AddressFullText>
    Thaerstrasse 11,
    Wiesbaden 65173
    Deutschland
  </nc:AddressFullText>
</nc:LocationAddress>
```

9.80. Place of Birth (XML) – Free text form - POB

AddressFullText

Field Reference: 2/POB/POB:X1
Content Type: Data_X
XML Tag Name: AddressFullText
Data Type: U
Minimum Length: 1
Minimum Occurrences: 0
Value range: *n/a*
Code table: *n/a*
Base type: nc:TextType

Field ID: [02.037:X1]
Condition: Dependent (see table)
Defined in: xsd/niem/niem-core/2.0/niem-core.xsd
Special Characters: [,-]
Maximum Length: *
Maximum Occurrences: 1
Regular Expression: *n/a*
Namespace: <http://niem.gov/niem/niem-core/2.0>

Dependency table

Type of dependency	Value
Mandatory on Absence of other Field	[2/POB/POB:X2]

XPath

```
/itl:PackageDescriptiveTextRecord
├─ /itl:UserDefinedDescriptiveDetail
│   └─ /itl:DomainDefinedDescriptiveDetail
│       └─ /int-i:RecordSubject
│           └─ /nc:PersonBirthLocation
│               └─ /nc:LocationAddress
│                   └─ /nc:AddressFullText
```

Summary

Place of birth of the subject being fingerprinted, in free text format.

Valid Examples

```
<nc:AddressFullText>
  Thaerstrasse 11,
  Wiesbaden 65173
  Deutschland
</nc:AddressFullText>
```

9.81. Place of Birth (XML) – Structured address form - POB

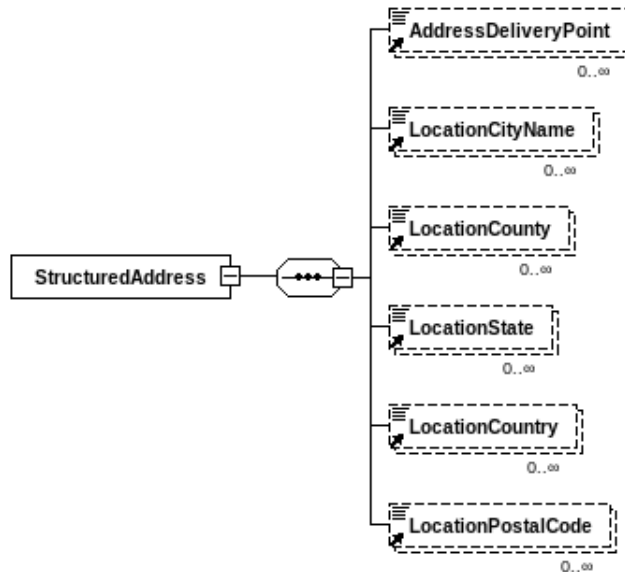

Field Reference: 2/POB/POB:X2
Content Type: Set_X
XML Tag Name: StructuredAddress
Data Type:
Minimum Length:
Minimum Occurrences: 0
Value range: *n/a*
Code table: *n/a*
Base type: nc:StructuredAddressType

Field ID: [02.037:X2-A_02.037:X2-G]
Condition: Dependent (see table)
Defined in: xsd/niem/niem-core/2.0/niem-core.xsd
Special Characters: *n/a*
Maximum Length:
Maximum Occurrences: 1
Regular Expression: *n/a*
Namespace: <http://niem.gov/niem/niem-core/2.0>

Dependency table

Type of dependency	Value
Mandatory on Absence of other Field	[2/POB/POB:X1]

XPath

```

/itl:PackageDescriptiveTextRecord
├── /itl:UserDefinedDescriptiveDetail
│   ├── /itl:DomainDefinedDescriptiveDetail
│   │   ├── /int-i:RecordSubject
│   │   │   ├── /nc:PersonBirthLocation
│   │   │   │   ├── /nc:LocationAddress
│   │   │   │   └── /nc:StructuredAddress
    
```

Summary

Place of birth of the subject being fingerprinted, in structured format.

Notes

When using a nc:StructuredAddress, at least the nc:LocationCountryISO3166Alpha3Code must be specified.

Valid Examples

```
<nc:StructuredAddress>
  <nc:LocationStreet>
    <nc:StreetNumberText>11</nc:StreetNumberText>
    <nc:StreetName>Thaerstrasse</nc:StreetName>
  </nc:LocationStreet>
  <nc:LocationCityName>Wiesbaden</nc:LocationCityName>
  <nc:LocationStateName>Hessen</nc:LocationStateName>
  <nc:LocationCountryISO3166Alpha3Code>DEU</nc:LocationCountryISO3166Alpha3Code>
  <nc:LocationPostalCode>65173</nc:LocationPostalCode>
</nc:StructuredAddress>
```

9.82. Place of Birth (XML) – Street number - PB1

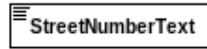

Field Reference: 2/POB/POB:X2/PB1
Content Type: Data_X
XML Tag Name: StreetNumberText
Data Type: AN
Minimum Length: 1
Minimum Occurrences: 0
Value range: *n/a*
Code table: *n/a*
Base type: nc:TextType

Field ID: [02.037:X2-A]
Condition: Optional within a field
Defined in: xsd/niem/niem-core/2.0/niem-core.xsd
Special Characters: *n/a*
Maximum Length: *
Maximum Occurrences: 1
Regular Expression: *n/a*
Namespace: <http://niem.gov/niem/niem-core/2.0>

XPath

```
/itl:PackageDescriptiveTextRecord
├── /itl:UserDefinedDescriptiveDetail
│   ├── /itl:DomainDefinedDescriptiveDetail
│   │   ├── /int-i:RecordSubject
│   │   │   ├── /nc:PersonBirthLocation
│   │   │   │   ├── /nc:LocationAddress
│   │   │   │   │   ├── /nc:StructuredAddress
│   │   │   │   │   │   ├── /nc:LocationStreet
│   │   │   │   │   │   │   └── /nc:StreetNumberText
```

Summary

In structured format, street number of the place of birth of the subject being fingerprinted.

9.83. Place of Birth (XML) – Street name - PB2

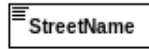

Field Reference: 2/POB/POB:X2/PB2
Content Type: Data_X
XML Tag Name: StreetName
Data Type: U
Minimum Length: 1
Minimum Occurrences: 0
Value range: *n/a*
Code table: *n/a*
Base type: nc:ProperNameTextType

Field ID: [02.037:X2-B]
Condition: Optional within a field
Defined in: xsd/niem/niem-core/2.0/niem-core.xsd
Special Characters: *n/a*
Maximum Length: *
Maximum Occurrences: 1
Regular Expression: *n/a*
Namespace: <http://niem.gov/niem/niem-core/2.0>

XPath

```
/itl:PackageDescriptiveTextRecord
├── /itl:UserDefinedDescriptiveDetail
│   ├── /itl:DomainDefinedDescriptiveDetail
│   │   ├── /int-i:RecordSubject
│   │   │   ├── /nc:PersonBirthLocation
│   │   │   │   ├── /nc:LocationAddress
│   │   │   │   │   ├── /nc:StructuredAddress
│   │   │   │   │   │   ├── /nc:LocationStreet
│   │   │   │   │   │   │   └── /nc:StreetName
```

Summary

In structured format, street name of the place of birth of the subject being fingerprinted.

9.84. Place of Birth (XML) – City name - PB3

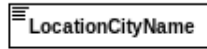

Field Reference: 2/POB/POB:X2/PB3
Content Type: Data_X
XML Tag Name: LocationCityName
Data Type: U
Minimum Length: 1
Minimum Occurrences: 0
Value range: *n/a*
Code table: *n/a*
Base type: nc:ProperNameTextType

Field ID: [02.037:X2-C]
Condition: Optional within a field
Defined in: xsd/niem/niem-core/2.0/niem-core.xsd
Special Characters: *n/a*
Maximum Length: *
Maximum Occurrences: 1
Regular Expression: *n/a*
Namespace: <http://niem.gov/niem/niem-core/2.0>

XPath

```
/itl:PackageDescriptiveTextRecord
├── /itl:UserDefinedDescriptiveDetail
│   ├── /itl:DomainDefinedDescriptiveDetail
│   │   ├── /int-i:RecordSubject
│   │   │   ├── /nc:PersonBirthLocation
│   │   │   │   ├── /nc:LocationAddress
│   │   │   │   │   ├── /nc:StructuredAddress
│   │   │   │   │   │   └── /nc:LocationCityName
```

Summary

In structured format, city name of the place of birth of the subject being fingerprinted.

9.85. Place of Birth (XML) – County name - PB4

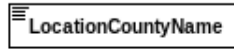

Field Reference: 2/POB/POB:X2/PB4
Content Type: Data_X
XML Tag Name: LocationCountyName
Data Type: U
Minimum Length: 1
Minimum Occurrences: 0
Value range: *n/a*
Code table: *n/a*
Base type: nc:ProperNameTextType

Field ID: [02.037:X2-D]
Condition: Optional within a field
Defined in: xsd/niem/niem-core/2.0/niem-core.xsd
Special Characters: *n/a*
Maximum Length: *
Maximum Occurrences: 1
Regular Expression: *n/a*
Namespace: <http://niem.gov/niem/niem-core/2.0>

XPath

```
/itl:PackageDescriptiveTextRecord
├── /itl:UserDefinedDescriptiveDetail
│   ├── /itl:DomainDefinedDescriptiveDetail
│   │   ├── /int-i:RecordSubject
│   │   │   ├── /nc:PersonBirthLocation
│   │   │   │   ├── /nc:LocationAddress
│   │   │   │   │   ├── /nc:StructuredAddress
│   │   │   │   │   └── /nc:LocationCountyName
```

Summary

In structured format, county, parish, or vicarage name of the place of birth of the subject being fingerprinted.

9.86. Place of Birth (XML) – State name - PB5

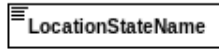

Field Reference: 2/POB/POB:X2/PB5
Content Type: Data_X
XML Tag Name: LocationStateName
Data Type: U
Minimum Length: 1
Minimum Occurrences: 0
Value range: *n/a*
Code table: *n/a*
Base type: nc:ProperNameTextType

Field ID: [02.037:X2-E]
Condition: Optional within a field
Defined in: xsd/niem/niem-core/2.0/niem-core.xsd
Special Characters: *n/a*
Maximum Length: *
Maximum Occurrences: 1
Regular Expression: *n/a*
Namespace: <http://niem.gov/niem/niem-core/2.0>

XPath

```
/itl:PackageDescriptiveTextRecord
├── /itl:UserDefinedDescriptiveDetail
│   ├── /itl:DomainDefinedDescriptiveDetail
│   │   ├── /int-i:RecordSubject
│   │   │   ├── /nc:PersonBirthLocation
│   │   │   │   ├── /nc:LocationAddress
│   │   │   │   │   ├── /nc:StructuredAddress
│   │   │   │   │   │   └── /nc:LocationStateName
```

Summary

In structured format, state name of the place of birth of the subject being fingerprinted.

9.87. Place of Birth (XML) – Country code - PB6

LocationCountryISO3166Alpha3Code

Field Reference: 2/POB/POB:X2/PB6

Content Type: Data_X

XML Tag Name: LocationCountryISO3166Alpha3Code

Data Type: U

Minimum Length: 1

Minimum Occurrences: 1

Value range: *n/a*

Code table: *n/a*

Base type: [iso_3166:CountryAlpha3CodeType](#)

Field ID: [02.037:X2-F]

Condition: Mandatory within a field

Defined in: [xsd/niem/niem-core/2.0/niem-core.xsd](#)

Special Characters: *n/a*

Maximum Length: *

Maximum Occurrences: 1

Regular Expression: *n/a*

Namespace: <http://niem.gov/niem/niem-core/2.0>

XPath

```
/itl:PackageDescriptiveTextRecord
├── /itl:UserDefinedDescriptiveDetail
│   ├── /itl:DomainDefinedDescriptiveDetail
│   │   ├── /int-i:RecordSubject
│   │   │   ├── /nc:PersonBirthLocation
│   │   │   │   ├── /nc:LocationAddress
│   │   │   │   │   ├── /nc:StructuredAddress
│   │   │   │   │   │   └── /nc:LocationCountryISO3166Alpha3Code
```

Summary

In structured format, country code in ISO3166 Alpha-3 format of the place of birth of the subject being fingerprinted.

9.88. Place of Birth (XML) – Postal code - PB7

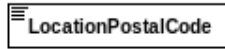

Field Reference: 2/POB/POB:X2/PB7
Content Type: Data_X
XML Tag Name: LocationPostalCode
Data Type: U
Minimum Length: 1
Minimum Occurrences: 0
Value range: *n/a*
Code table: *n/a*
Base type: niem-xsd:string

Field ID: [02.037:X2-G]
Condition: Optional within a field
Defined in: xsd/niem/niem-core/2.0/niem-core.xsd
Special Characters: *n/a*
Maximum Length: *
Maximum Occurrences: 1
Regular Expression: *n/a*
Namespace: <http://niem.gov/niem/niem-core/2.0>

XPath

```
/itl:PackageDescriptiveTextRecord
├── /itl:UserDefinedDescriptiveDetail
│   ├── /itl:DomainDefinedDescriptiveDetail
│   │   ├── /int-i:RecordSubject
│   │   │   ├── /nc:PersonBirthLocation
│   │   │   │   ├── /nc:LocationAddress
│   │   │   │   │   ├── /nc:StructuredAddress
│   │   │   │   │   └── /nc:LocationPostalCode
```

Summary

In structured format, postal or ZIP code of the place of birth of the subject being fingerprinted.

9.89. Nationality - NAT

 PersonCitizenshipISO3166Alpha3Code

Field Reference: 2/NAT
Content Type: Data
XML Tag Name: PersonCitizenshipISO3166Alpha3Code
Data Type: A
Minimum Length: 3
Minimum Occurrences: 0
Value range: *n/a*
Code table: *n/a*
Base type: [iso_3166:CountryAlpha3CodeType](#)

Field ID: [02.038]
Condition: Dependent (see table)
Defined in: xsd/niem/niem-core/2.0/niem-core.xsd
Special Characters: *n/a*
Maximum Length: 3
Maximum Occurrences: 1
Regular Expression: *n/a*

Namespace: <http://niem.gov/niem/niem-core/2.0>

Dependency table

Type of dependency	Value
Mandatory on Value of other Field, optional otherwise.	[1/TOT]="ATP"

XPath

```

/itl:PackageDescriptiveTextRecord
├── /itl:UserDefinedDescriptiveDetail
│   ├── /itl:DomainDefinedDescriptiveDetail
│   │   ├── /int-i:RecordSubject
│   │   │   └── /nc:PersonCitizenshipISO3166Alpha3Code
    
```

Summary

The ISO3166 Alpha3 code of the nationality of the subject being fingerprinted.

Valid Examples

<pre><nc:PersonCitizenshipISO3166Alpha3Code>DEU</nc:PersonCitizenshipISO3166Alpha3Code></pre>

9.90. Sex - SEX

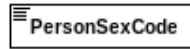

Field Reference: 2/SEX

Content Type: Data

XML Tag Name: PersonSexCode

Data Type: A

Minimum Length: 1

Minimum Occurrences: 0

Value range: {"M","F","U"}

Code table: see table [A.58](#)

Base type: int-i:PersonSexCodeType

Field ID: [02.039]

Condition: Optional

Defined in: xsd/int-i/1.0/int-i.xsd

Special Characters: *n/a*

Maximum Length: 1

Maximum Occurrences: 1

Regular Expression: *n/a*

Namespace: <http://interpol.int/int-i/1.0>

Dependency table

Type of dependency	Value
Mandatory on Value of other Field, optional otherwise.	[1/TOT]="ATP" [1/TOT]="CPS"

XPath

```
/itl:PackageDescriptiveTextRecord
└─/itl:UserDefinedDescriptiveDetail
  └─/itl:DomainDefinedDescriptiveDetail
    └─/int-i:RecordSubject
      └─/int-i:PersonSexCode
```

Summary

Sex of the subject being fingerprinted.

Valid Examples

```
<int-i:PersonSexCode>M</int-i:PersonSexCode>
```

9.91. Offence Description Text - OTY

OffenceDescriptionText

Field Reference: 2/OTY:X
Content Type: Data_X
XML Tag Name: OffenceDescriptionText
Data Type: U
Minimum Length: 1
Minimum Occurrences: 0
Value range: *n/a*
Code table: *n/a*
Base type: nc:TextType

Field ID: [02.054:X]
Condition: Dependent (see table)
Defined in: xsd/int-i/1.0/int-i.xsd
Special Characters: ALL
Maximum Length: *
Maximum Occurrences: 1
Regular Expression: *n/a*

Namespace: <http://interpol.int/int-i/1.0>

Dependency table

Type of dependency	Value
Mandatory on Value of other Field, optional otherwise.	[2/RFP]="NLC"

XPath

```

/itl:PackageDescriptiveTextRecord
├─ /itl:UserDefinedDescriptiveDetail
│   └─ /itl:DomainDefinedDescriptiveDetail
│       └─ /int-i:RecordOffence
│           └─ /int-i:OffenceDescriptionText
    
```

Summary

Description of the crime committed.

Valid Examples

```
<int-i:OffenceDescriptionText>Kidnapped Perry the platypus</int-i:OffenceDescriptionText>
```

9.92. Date (and Time) of Offence (XML) - DOO

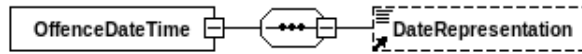

Field Reference: 2/DOO:X
Content Type: Data_X
XML Tag Name: OffenceDateTime
Data Type: ANS
Minimum Length: 10
Minimum Occurrences: 0
Value range: *n/a*
Code table: *n/a*
Base type: [niem-xsd:date](#) or [niem-xsd:dateTime](#)

Field ID: [02.055:X]
Condition: Dependent (see table)
Defined in: [xsd/int-i/1.0/int-i.xsd](#)
Special Characters: [-]
Maximum Length: 19
Maximum Occurrences: 1
Regular Expression: *n/a*
Namespace: <http://interpol.int/int-i/1.0>

Dependency table

Type of dependency	Value
Mandatory on Absence of other Field	[2/DOR:X]
Mandatory on Value of other Field, optional otherwise.	[1/TOT]="MPS"

XPath

```

/itl:PackageDescriptiveTextRecord
  ↳/itl:UserDefinedDescriptiveDetail
    ↳/itl:DomainDefinedDescriptiveDetail
      ↳/int-i:RecordOffence
        ↳/int-i:OffenceDateTime
          ↳/nc:DateTime
or
/itl:PackageDescriptiveTextRecord
  ↳/itl:UserDefinedDescriptiveDetail
    ↳/itl:DomainDefinedDescriptiveDetail
      ↳/int-i:RecordOffence
        ↳/int-i:OffenceDateTime
          ↳/nc:Date
    
```

Summary

Date (and possibly time) on which the Offence was committed.

Notes

Either the date of offence (DOO/2.055) or the date of offence range (DOR/2.056) can be used, but not both at the same time.

Valid Examples

```

<int-i:OffenceDateTime>
  <nc:DateTime>2016-12-17T15:00:00</nc:DateTime>
<int-i:OffenceDateTime>
or
<int-i:OffenceDateTime>
  <nc:Date>2016-12-17</nc:Date>
<int-i:OffenceDateTime>
    
```

9.93. Date of Offence Range (XML) - DOR

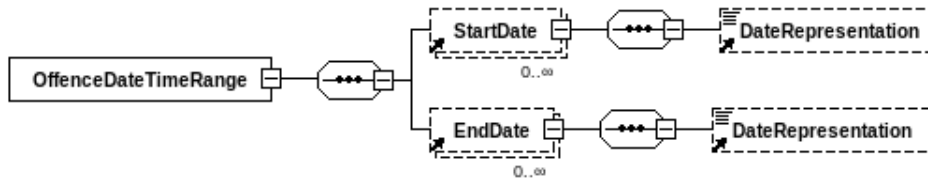

Field Reference: 2/DOR:X
Content Type: Set_X
XML Tag Name: OffenceDateTimeRange
Data Type:
Minimum Length:
Minimum Occurrences: 0
Value range: n/a
Code table: n/a
Base type: nc:DateRangeType

Field ID: [02.056-A_02.056-B]]
Condition: Dependent (see table)
Defined in: xsd/int-i/1.0/int-i.xsd
Special Characters: n/a
Maximum Length:
Maximum Occurrences: 1
Regular Expression: n/a
Namespace: <http://interpol.int/int-i/1.0>

Dependency table

Type of dependency	Value
Mandatory on Absence of other Field	[2/DOO:X]
Mandatory on Value of other Field, optional otherwise.	[1/TOT]="MPS"

XPath

```

/itl:PackageDescriptiveTextRecord
├─ /itl:UserDefinedDescriptiveDetail
│   └─ /itl:DomainDefinedDescriptiveDetail
│       └─ /int-i:RecordOffence
│           └─ /int-i:OffenceDateTimeRange
    
```

Summary

Date (and possible time) range during which the offence was committed.

Notes

Either the date of offence (DOO/2.055) or the date of offence range (DOR/2.056) can be used, but not both at the same time.

Valid Examples

```

<int-i:OffenceDateTimeRange>
  <nc:StartDate>
    <nc:DateTime>2016-12-17T17:00:00</nc:DateTime>
  </nc:StartDate>
  <nc:EndDate>
    <nc:Date>2016-12-18</nc:Date>
  </nc:EndDate>
</int-i:OffenceDateTimeRange>
    
```

9.94. Date (and Time) of Offence Range (XML) - Min Date - SDA

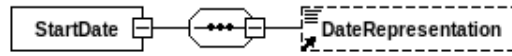

Field Reference: 2/DOR/SDA

Content Type: Data_X

XML Tag Name: StartDate

Data Type: ANS

Minimum Length: 10

Minimum Occurrences: 0

Value range: *n/a*

Code table: *n/a*

Base type: [niem-xsd:date](#) or [niem-xsd:dateTime](#)

Field ID: [02.056-A]

Condition: Mandatory within a field

Defined in: [xsd/niem/niem-core/2.0/niem-core.xsd](#)

Special Characters: [-:]

Maximum Length: 19

Maximum Occurrences: 1

Regular Expression: `\d{4}-\d{2}-\d{2}(T\d{2}:\d{2}:\d{2}(Z){0,1}){0,1}`

Namespace: <http://niem.gov/niem/niem-core/2.0>

XPath

```

/itl:PackageDescriptiveTextRecord
  ↳/itl:UserDefinedDescriptiveDetail
    ↳/itl:DomainDefinedDescriptiveDetail
      ↳/int-i:RecordOffence
        ↳/int-i:OffenceDateTimeRange
          ↳/nc:StartDate
            ↳/nc:DateTime
  
```

or

```

/itl:PackageDescriptiveTextRecord
  ↳/itl:UserDefinedDescriptiveDetail
    ↳/itl:DomainDefinedDescriptiveDetail
      ↳/int-i:RecordOffence
        ↳/int-i:OffenceDateTimeRange
          ↳/nc:StartDate
            ↳/nc>Date
  
```

Summary

Start of the date (and time) of offence range of the subject being fingerprinted.

Valid Examples

```

<nc:StartDate><nc>Date>2016-12-17</nc>Date></nc:StartDate>
or
<nc:StartDate><nc:DateTime>2016-12-17T11:00:00</nc:DateTime></nc:StartDate>
  
```

9.95. Date (and Time) of Offence Range (XML) - Max Date - EDA

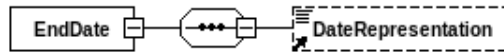

Field Reference: 2/DOR/EDA

Content Type: Data_X

XML Tag Name: EndDate

Data Type: ANS

Minimum Length: 10

Minimum Occurrences: 0

Value range: *n/a*

Code table: *n/a*

Base type: [niem-xsd:date](#) or [niem-xsd:dateTime](#)

Field ID: [02.056-B]

Condition: Mandatory within a field

Defined in: [xsd/niem/niem-core/2.0/niem-core.xsd](#)

Special Characters: [-]

Maximum Length: 19

Maximum Occurrences: 1

Regular Expression: `\d{4}-\d{2}-\d{2}(T\d{2}:\d{2}:\d{2}(Z){0,1}){0,1}`

Namespace: <http://niem.gov/niem/niem-core/2.0>

XPath

```

/itl:PackageDescriptiveTextRecord
  ↳/itl:UserDefinedDescriptiveDetail
    ↳/itl:DomainDefinedDescriptiveDetail
      ↳/int-i:RecordOffence
        ↳/int-i:OffenceDateTimeRange
          ↳/nc:EndDate
          ↳/nc:DateTime
  or

```

```

/itl:PackageDescriptiveTextRecord
  ↳/itl:UserDefinedDescriptiveDetail
    ↳/itl:DomainDefinedDescriptiveDetail
      ↳/int-i:RecordOffence
        ↳/int-i:OffenceDateTimeRange
          ↳/nc:EndDate
          ↳/nc>Date

```

Summary

End of the date (and time) of offence range of the subject being fingerprinted.

Valid Examples

```

<nc:EndDate><nc>Date>2016-12-18</nc>Date></nc:EndDate>
or
<nc:EndDate><nc:DateTime>2016-12-18T10:00:00</nc:DateTime></nc:EndDate>

```

9.96. Additional Contact Information - INF

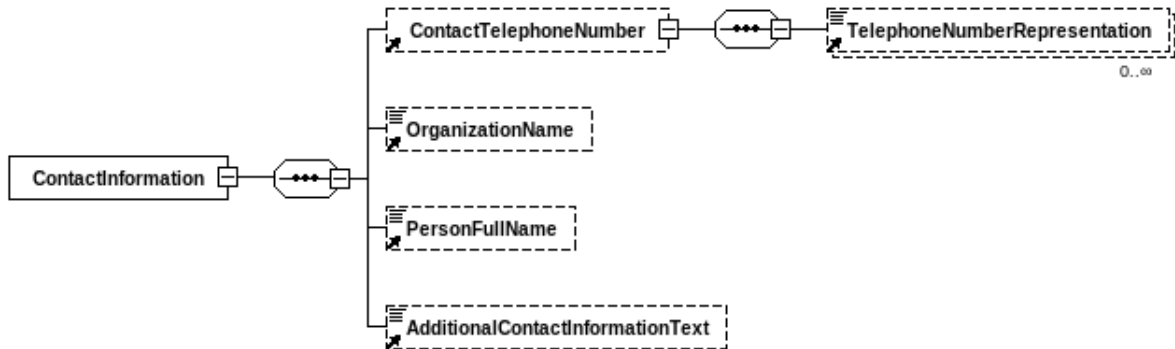

Field Reference: 2/INF:X
Content Type: Set_X
XML Tag Name: ContactInformation
Data Type: U
Minimum Length:
Minimum Occurrences: 0
Value range: *n/a*
Code table: *n/a*
Base type: int-i:ContactInformationType

Field ID: [02.063-A_02.063-D]
Condition: Optional
Defined in: xsd/int-i/1.0/int-i.xsd
Special Characters: *n/a*
Maximum Length:
Maximum Occurrences: 1
Regular Expression: *n/a*
Namespace: <http://interpol.int/int-i/1.0>

XPath

```

/itl:PackageDescriptiveTextRecord
├─ /itl:UserDefinedDescriptiveDetail
│   └─ /itl:DomainDefinedDescriptiveDetail
│       └─ /int-i:RecordMetadata
│           └─ /int-i:ContactInformation
  
```

Summary

Additional contact point to get further information about the request

Valid Examples

```

<int-i:ContactInformation>
  <nc:ContactTelephoneNumber>
    <nc:FullTelephoneNumber>
      <nc:TelephoneNumberFullID>447700954321</nc:TelephoneNumberFullID>
    </nc:FullTelephoneNumber>
  </nc:ContactTelephoneNumber>
  <nc:OrganizationName>Interpol</nc:OrganizationName>
  <nc:PersonFullName>Helock Sholmes</nc:PersonFullName>
  <int-i:AdditionalContactInformationText>Contact Immediately. Terrorist.</int-i:
  AdditionalContactInformationText>
</int-i:ContactInformation>
  
```

9.97. Telephone number for the additional contact information - IN1

 TelephoneNumberFullID

Field Reference: 2/INF/TEL
Content Type: Data_X
XML Tag Name: TelephoneNumberFullID
Data Type: N
Minimum Length: 0
Minimum Occurrences: 0
Value range: *n/a*
Code table: *n/a*
Base type: niem-xsd:string

Field ID: [02.063-A]
Condition: Optional within a field
Defined in: xsd/niem/niem-core/2.0/niem-core.xsd
Special Characters: *n/a*
Maximum Length: 64
Maximum Occurrences: 1
Regular Expression: *n/a*

Namespace: <http://niem.gov/niem/niem-core/2.0>

XPath

```
/itl:PackageDescriptiveTextRecord
├─ /itl:UserDefinedDescriptiveDetail
│   └─ /itl:DomainDefinedDescriptiveDetail
│       └─ /int-i:RecordMetadata
│           └─ /int-i:ContactInformation
│               └─ /nc:ContactTelephoneNumber
│                   └─ /nc:FullTelephoneNumber
│                       └─ /nc:TelephoneNumberFullID
```

Summary

Telephone number of the additional contact point

Notes

INTERPOL implementation does not allow to use the nc:TelephoneSuffixID element along with the nc:TelephoneNumberFullID.

Valid Examples

```
<nc:TelephoneNumberFullID>447700954321</nc:TelephoneNumberFullID>
```

9.98. Organization name for the additional contact information - IN2

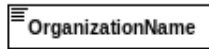

Field Reference: 2/INF/ONM
Content Type: Data_X
XML Tag Name: OrganizationName
Data Type: ANS
Minimum Length: 0
Minimum Occurrences: 0
Value range: *n/a*
Code table: *n/a*
Base type: nc:TextType

Field ID: [02.063-B]
Condition: Optional within a field
Defined in: xsd/niem/niem-core/2.0/niem-core.xsd
Special Characters: *n/a*
Maximum Length: 64
Maximum Occurrences: 1
Regular Expression: *n/a*

Namespace: <http://niem.gov/niem/niem-core/2.0>

XPath

```
/itl:PackageDescriptiveTextRecord  
  ↳/itl:UserDefinedDescriptiveDetail  
    ↳/itl:DomainDefinedDescriptiveDetail  
      ↳/int-i:RecordMetadata  
        ↳/int-i:ContactInformation  
          ↳/nc:OrganizationName
```

Summary

Name of the organization the additional contact point belong to

Valid Examples

```
<nc:OrganizationName>INTERPOL</nc:OrganizationName>
```

9.99. Person full name for the additional contact information - IN3

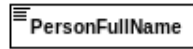

Field Reference: 2/INF/PFN
Content Type: Data_X
XML Tag Name: PersonFullName
Data Type: ANS
Minimum Length: 0
Minimum Occurrences: 0
Value range: *n/a*
Code table: *n/a*
Base type: nc:PersonNameTextType

Field ID: [02.063-C]
Condition: Optional within a field
Defined in: xsd/niem/niem-core/2.0/niem-core.xsd
Special Characters: *n/a*
Maximum Length: 64
Maximum Occurrences: 1
Regular Expression: *n/a*

Namespace: <http://niem.gov/niem/niem-core/2.0>

XPath

```
/itl:PackageDescriptiveTextRecord
├─ /itl:UserDefinedDescriptiveDetail
│   └─ /itl:DomainDefinedDescriptiveDetail
│       └─ /int-i:RecordMetadata
│           └─ /int-i:ContactInformation
│               └─ /nc:PersonFullName
```

Summary

Person full name of the additional contact point

Valid Examples

```
<nc:PersonFullName>Herlock Sholmes</nc:PersonFullName>
```

9.100. Additional information for the additional contact information - IN4

 AdditionalContactInformationText

Field Reference: 2/INF/ACI
Content Type: Data_X
XML Tag Name: AdditionalContactInformationText
Data Type: ANS
Minimum Length: 0
Minimum Occurrences: 0
Value range: *n/a*
Code table: *n/a*
Base type: nc:TextType

Field ID: [02.063-D]
Condition: Optional within a field
Defined in: xsd/int-i/1.0/int-i.xsd
Special Characters: *n/a*
Maximum Length: 64
Maximum Occurrences: 1
Regular Expression: *n/a*
Namespace: <http://interpol.int/int-i/1.0>

XPath

```
/itl:PackageDescriptiveTextRecord  
  ↳/itl:UserDefinedDescriptiveDetail  
    ↳/itl:DomainDefinedDescriptiveDetail  
      ↳/int-i:RecordMetadata  
        ↳/int-i:ContactInformation  
          ↳/int-i:AdditionalContactInformationText
```

Summary

Additional comment

Valid Examples

```
<int-i:AdditionalContactInformationText>Contact Immediately. Terrorist.</int-i:AdditionalContactInformationText>
```

9.101. Respondent List (XML) - RLS

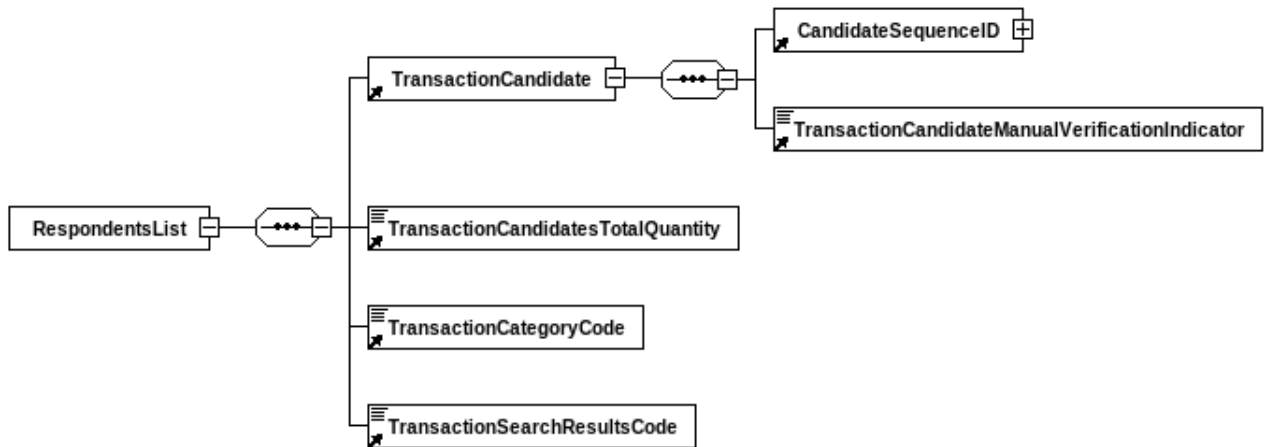

Field Reference: 2/RLS:X
Content Type: Set_X
XML Tag Name: RespondentsList
Data Type:
Minimum Length:
Minimum Occurrences: 0
Value range: n/a
Code table: n/a
Base type: int-i:RespondentsListType

Field ID: [02.064-A_02064-E]
Condition: Dependent (see table)
Defined in: xsd/int-i/1.0/int-i.xsd
Special Characters: n/a
Maximum Length:
Maximum Occurrences: 1
Regular Expression: n/a
Namespace: <http://interpol.int/int-i/1.0>

Dependency table

Type of dependency	Value
Mandatory on Value of other Field, optional otherwise.	[1/TOT]="SRE"

XPath

```

/itl:PackageDescriptiveTextRecord
  ↳/itl:UserDefinedDescriptiveDetail
    ↳/itl:DomainDefinedDescriptiveDetail
      ↳/int-i:TransactionResponseData
        ↳/int-i:RespondentsList
  
```

Summary

Result for a search request.

This field contains 3 subfields in case of a no-hit and 5 in case of a hit. Each search response message can convey at most one candidate. In case of multiple hits, multiple SRE must be sent to the requester.

The identifiers of the candidates are not transmitted in this structure, but rather in the standard identifier fields of the Type 2.

Valid Examples

```
<int-i:RespondentsList>
  <int-i:TransactionCandidate>
    <int-i:CandidateSequenceID>
      <nc:IdentificationID>1</nc:IdentificationID>
    </int-i:CandidateSequenceID>
    <int-i:TransactionCandidateManualVerificationIndicator>true</int-i:TransactionCandidateManualVerificationIndicator>
  </int-i:TransactionCandidate>
  <int-i:TransactionCandidatesTotalQuantity>3</int-i:TransactionCandidatesTotalQuantity>
  <int-i:TransactionCategoryCode>CPS</int-i:TransactionCategoryCode>
  <int-i:TransactionSearchResultsCode>I</int-i:TransactionSearchResultsCode>
</int-i:RespondentsList>
```

9.102. Candidate Sequence ID - CSI

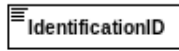

Field Reference: 2/RLS/CSI
Content Type: Data_X
XML Tag Name: IdentificationID
Data Type: N
Minimum Length: 1
Minimum Occurrences: 1
Value range: \d{1,2}
Code table: n/a
Base type: niem-xsd:string

Field ID: [02.064-A]
Condition: Dependent (see table)
Defined in: xsd/niem/niem-core/2.0/niem-core.xsd
Special Characters: n/a
Maximum Length: 2
Maximum Occurrences: 1
Regular Expression: n/a

Namespace: <http://niem.gov/niem/niem-core/2.0>

Dependency table

Type of dependency	Value
Mandatory on Value of other Field, optional otherwise.	[2/RLS/SRC]="I"

XPath

```

/itl:PackageDescriptiveTextRecord
  ↳/itl:UserDefinedDescriptiveDetail
    ↳/itl:DomainDefinedDescriptiveDetail
      ↳/int-i:TransactionResponseData
        ↳/int-i:RespondentsList
          ↳/int-i:TransactionCandidate
            ↳/int-i:CandidateSequenceID
              ↳/nc:IdentificationID
    
```

Summary

In case of a hit, this field represents the number of the candidate transmitted in the current message (out of the total number of candidates)

Valid Examples

```
<nc:IdentificationID>1</nc:IdentificationID>
```

9.103. Candidate Manual Verification Indicator - MVI

TransactionCandidateManualVerificationIndicator

Field Reference: 2/RLS/MVI

Content Type: Data_X

XML Tag Name: TransactionCandidateManualVerificationIndicator

Data Type: A

Minimum Length:

Minimum Occurrences: 1

Value range: {"true", "false"}

Code table: *n/a*

Base type: niem-xsd:boolean

Field ID: [02.064-B]

Condition: Dependent (see table)

Defined in: xsd/int-i/1.0/int-i.xsd

Special Characters: *n/a*

Maximum Length:

Maximum Occurrences: 1

Regular Expression: *n/a*

Namespace: <http://interpol.int/int-i/1.0>

Dependency table

Type of dependency	Value
Mandatory on Value of other Field, optional otherwise.	[2/RLS/SRC]="I"

XPath

```

/itl:PackageDescriptiveTextRecord
  ↳/itl:UserDefinedDescriptiveDetail
    ↳/itl:DomainDefinedDescriptiveDetail
      ↳/int-i:TransactionResponseData
        ↳/int-i:RespondentsList
          ↳/int-i:TransactionCandidate
            ↳/int-i:TransactionCandidateManualVerificationIndicator
  
```

Summary

In case of a hit, this field indicates whether the candidate has been manually verified or not.

Valid Examples

```
<int-i:TransactionCandidateManualVerificationIndicator>true</int-i:TransactionCandidateManualVerificationIndicator>
```

9.104. Candidates Total Quantity - CTQ

TransactionCandidatesTotalQuantity

<p>Field Reference: 2/RLS/CTQ Content Type: Data_X XML Tag Name: TransactionCandidatesTotalQuantity Data Type: N Minimum Length: 1 Minimum Occurrences: 1 Value range: \d{1,2} Code table: n/a Base type: niem-xsd:nonNegativeInteger</p>	<p>Field ID: [02.064-C] Condition: Dependent (see table) Defined in: xsd/int-i/1.0/int-i.xsd Special Characters: n/a Maximum Length: 2 Maximum Occurrences: 1 Regular Expression: n/a Namespace: http://interpol.int/int-i/1.0</p>
--	---

Type of dependency	Value
Mandatory on Value of other Field, optional otherwise.	[2/RLS/SRC]="I"

XPath

```

/itl:PackageDescriptiveTextRecord
├─ /itl:UserDefinedDescriptiveDetail
│   └─ /itl:DomainDefinedDescriptiveDetail
│       └─ /int-i:TransactionResponseData
│           └─ /int-i:RespondentsList
│               └─ /int-i:TransactionCandidatesTotalQuantity
    
```

Summary

In case of a hit, this field indicates the total number of candidates that the search yielded. As many SRE messages as candidates will be sent back to the requester.

Valid Examples

```
<int-i:TransactionCandidatesTotalQuantity>3</int-i:TransactionCandidatesTotalQuantity>
```

9.105. Transaction Category Code - CAC

 TransactionCategoryCode

Field Reference: 2/RLS/CAC
Content Type: Data_X
XML Tag Name: TransactionCategoryCode
Data Type: AS
Minimum Length: 3
Minimum Occurrences: 1
Value range: *n/a*
Code table: see table [A.60](#)
Base type: int-i:TransactionCategoryCodeType

Field ID: [02.064-D]
Condition: Mandatory within a field
Defined in: xsd/int-i/1.0/int-i.xsd
Special Characters: *n/a*
Maximum Length: 3
Maximum Occurrences: 1
Regular Expression: *n/a*
Namespace: <http://interpol.int/int-i/1.0>

XPath

```
/itl:PackageDescriptiveTextRecord  
  ↳/itl:UserDefinedDescriptiveDetail  
    ↳/itl:DomainDefinedDescriptiveDetail  
      ↳/int-i:TransactionResponseData  
        ↳/int-i:RespondentsList  
          ↳/int-i:TransactionCategoryCode
```

Summary

This field contains the mnemonic of the type of search that has been carried out.

Valid Examples

<code><int-i:TransactionCategoryCode>CPS</int-i:TransactionCategoryCode></code>

9.106. Transaction Search Results Code - SRC

 TransactionSearchResultsCode

Field Reference: 2/RLS/SRC
Content Type: Data_X
XML Tag Name: TransactionSearchResultsCode
Data Type: A
Minimum Length: 1
Minimum Occurrences: 1
Value range: {"I","N"}
Code table: *n/a*
Base type: int-i:TransactionSearchResultsCodeType

Field ID: [02.064-E]
Condition: Mandatory within a field
Defined in: xsd/int-i/1.0/int-i.xsd
Special Characters: *n/a*
Maximum Length: 1
Maximum Occurrences: 1
Regular Expression: *n/a*
Namespace: <http://interpol.int/int-i/1.0>

XPath

```
/itl:PackageDescriptiveTextRecord
└─/itl:UserDefinedDescriptiveDetail
  └─/itl:DomainDefinedDescriptiveDetail
    └─/int-i:TransactionResponseData
      └─/int-i:RespondentsList
        └─/int-i:TransactionSearchResultsCode
```

Summary

This field contains a single character that gives the outcome of the search: I if candidates were found, N if not.

Valid Examples

```
<int-i:TransactionSearchResultsCode>I</int-i:TransactionSearchResultsCode>
```

9.107. Error Message (XML) - ERM

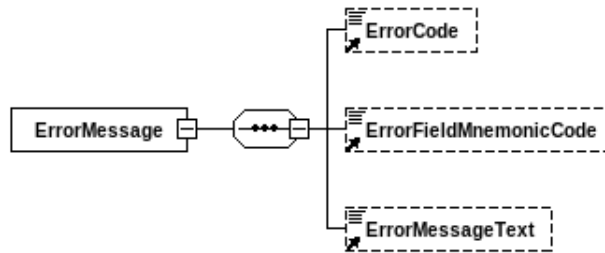

Field Reference: 2/ERM:X
Content Type: Set_X
XML Tag Name: ErrorMessage
Data Type:
Minimum Length:
Minimum Occurrences: 0
Value range: *n/a*
Code table: *n/a*
Base type: int-i:ErrorMessageType

Field ID: [02.074-A_02.074-C]
Condition: Dependent (see table)
Defined in: xsd/int-i/1.0/int-i.xsd
Special Characters: *n/a*
Maximum Length:
Maximum Occurrences: 1
Regular Expression: *n/a*
Namespace: <http://interpol.int/int-i/1.0>

Dependency table

Type of dependency	Value
Mandatory on Value of other Field, optional otherwise.	[1/TOT]="ERR"

XPath

```

/itl:PackageDescriptiveTextRecord
├─ /itl:UserDefinedDescriptiveDetail
│   └─ /itl:DomainDefinedDescriptiveDetail
│       └─ /int-i:TransactionResponseData
│           └─ /int-i:ErrorMessage
    
```

Summary

This field is a structure that contains the error message resulting from a transaction which will be sent back to the requester.

Valid Examples

```

<int-i:ErrorMessage>
  <int-i:ErrorCode>101</int-i:ErrorCode>
  <int-i:ErrorFieldMnemonicCode>NAM</int-i:ErrorFieldMnemonicCode>
  <int-i:ErrorMessageText>MANDATORY FIELD MISSING</int-i:ErrorMessageText>
</int-i:ErrorMessage>
    
```

9.108. Error code - ECO

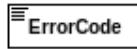

Field Reference: 2/ERM/ECO
Content Type: Data_X
XML Tag Name: ErrorCode
Data Type: N
Minimum Length: 3
Minimum Occurrences: 0
Value range: *n/a*
Code table: see table [A.22](#)
Base type: int-i:ErrorCodeType

Field ID: [02.074-A]
Condition: Mandatory within a field
Defined in: xsd/int-i/1.0/int-i.xsd
Special Characters: *n/a*
Maximum Length: 3
Maximum Occurrences: 1
Regular Expression: *n/a*
Namespace: <http://interpol.int/int-i/1.0>

XPath

```

/itl:PackageDescriptiveTextRecord
  ↳/itl:UserDefinedDescriptiveDetail
    ↳/itl:DomainDefinedDescriptiveDetail
      ↳/int-i:TransactionResponseData
        ↳/int-i:ErrorMessage
          ↳/int-i:ErrorCode
  
```

Summary

This field contains the numeric error code.

Notes

The error codes and the corresponding messages are given in table [A.22](#) in annex [A](#).

Valid Examples

```
<int-i:ErrorCode>101</int-i:ErrorCode>
```

9.109. Error Field Mnemonic Code - EFM

 ErrorFieldMnemonicCode

Field Reference: 2/ERM/EFM
Content Type: Data_X
XML Tag Name: ErrorFieldMnemonicCode
Data Type: A
Minimum Length: 3
Minimum Occurrences: 0
Value range: *n/a*
Code table: *n/a*
Base type: nc:TextType

Field ID: [02.074-B]
Condition: Mandatory within a field
Defined in: xsd/int-i/1.0/int-i.xsd
Special Characters: *n/a*
Maximum Length: 3
Maximum Occurrences: 1
Regular Expression: *n/a*
Namespace: <http://interpol.int/int-i/1.0>

XPath

```
/itl:PackageDescriptiveTextRecord  
  ↳/itl:UserDefinedDescriptiveDetail  
    ↳/itl:DomainDefinedDescriptiveDetail  
      ↳/int-i:TransactionResponseData  
        ↳/int-i:ErrorMessage  
          ↳/int-i:ErrorFieldMnemonicCode
```

Summary

This field contains the 3-letter mnemonic of the field that caused the error.

Valid Examples

```
<int-i:ErrorFieldMnemonicCode>NAM</int-i:ErrorFieldMnemonicCode>
```

9.110. Error Message Text - EMT



Field Reference: 2/ERM/EMT
Content Type: Data_X
XML Tag Name: ErrorMessageText
Data Type: ANS
Minimum Length: 0
Minimum Occurrences: 0
Value range: *n/a*
Code table: see table [A.22](#)
Base type: nc:TextType

Field ID: [02.074-C]
Condition: Mandatory within a field
Defined in: xsd/int-i/1.0/int-i.xsd
Special Characters: *n/a*
Maximum Length: 128
Maximum Occurrences: 1
Regular Expression: *n/a*

Namespace: <http://interpol.int/int-i/1.0>

XPath

```

/itl:PackageDescriptiveTextRecord
├─ /itl:UserDefinedDescriptiveDetail
│   └─ /itl:DomainDefinedDescriptiveDetail
│       └─ /int-i:TransactionResponseData
│           └─ /int-i:ErrorMessage
│               └─ /int-i:ErrorMessageText
  
```

Summary

This field contains the error message text corresponding to the numeric error code of the previous field.

Notes

The error codes and the corresponding messages are given in table [A.22](#) in annex [A](#).

Valid Examples

```
<int-i:ErrorMessageText>MANDATORY FIELD MISSING</int-i:ErrorMessageText>
```

9.111. Father's name - FFN

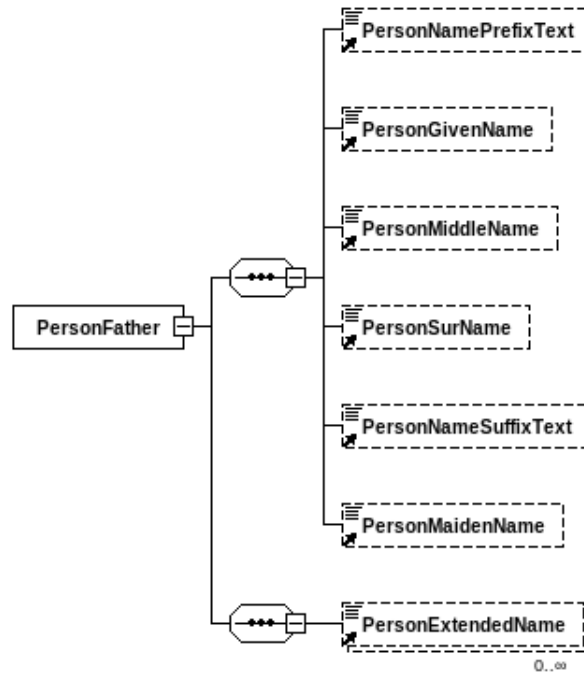

Field Reference: 2/FFN
Content Type: Set_X
XML Tag Name: PersonFather
Data Type:
Minimum Length:
Minimum Occurrences: 0
Value range: *n/a*
Code table: *n/a*
Base type: int-i:PersonNameType

Field ID: [02.075:X]
Condition: Optional
Defined in: xsd/int-i/1.0/int-i.xsd
Special Characters: *n/a*
Maximum Length:
Maximum Occurrences: 1
Regular Expression: *n/a*
Namespace: <http://interpol.int/int-i/1.0>

XPath

```

    /itl:PackageDescriptiveTextRecord
      ↙/itl:UserDefinedDescriptiveDetail
        ↙/itl:DomainDefinedDescriptiveDetail
          ↙/int-i:RecordSubject
            ↙/int-i:PersonFather
  
```

Summary

This field specifies the identity of the father of the person being fingerprinted, in particular his family name.

It has the same structure as the field 2.030/NAM, but most likely you would only specify the nc:PersonSurName

Valid Examples

```
<int-i:PersonFather>  
  <nc:PersonGivenName>Max</nc:PersonGivenName>  
  <nc:PersonSurName>Schneider</nc:PersonSurName>  
</int-i:PersonFather>
```

9.112. Mother's family name - MMN

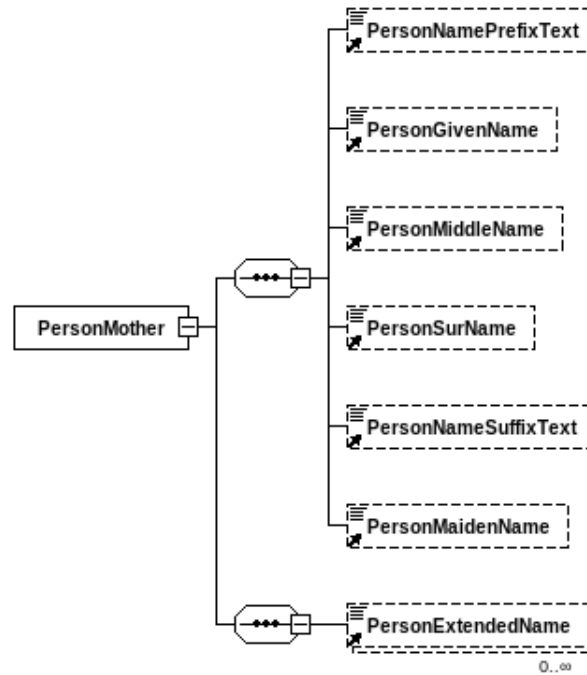

Field Reference: 2/MMN
Content Type: Set_X
XML Tag Name: PersonMother
Data Type:
Minimum Length:
Minimum Occurrences: 0
Value range: *n/a*
Code table: *n/a*
Base type: int-i:PersonNameType

Field ID: [02.076:X]
Condition: Optional
Defined in: xsd/int-i/1.0/int-i.xsd
Special Characters: *n/a*
Maximum Length:
Maximum Occurrences: 1
Regular Expression: *n/a*
Namespace: <http://interpol.int/int-i/1.0>

XPath

```

/itl:PackageDescriptiveTextRecord
├── /itl:UserDefinedDescriptiveDetail
│   ├── /itl:DomainDefinedDescriptiveDetail
│   │   ├── /int-i:RecordSubject
│   │   └── /int-i:PersonMother
    
```

Summary

This field specifies the identity of the mother of the person being fingerprinted, in particular her maiden name.

It has the same structure as the field 2.030/NAM, but most likely you would only specify the nc:PersonMaidenName

Valid Examples

```
<int-i:PersonMother>  
  <nc:PersonGivenName>Sabine</nc:PersonGivenName>  
  <nc:PersonMaidenName>Meyer</nc:PersonMaidenName>  
</int-i:PersonMother>
```

9.113. Latent Matching Position - LMP

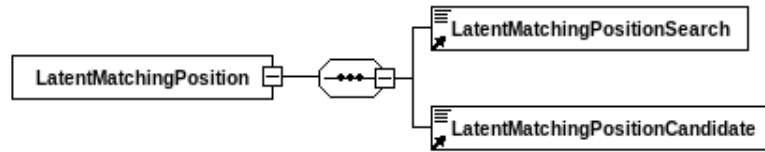

Field Reference: 2/LMP
Content Type: Set_X
XML Tag Name: LatentMatchingPosition
Data Type:
Minimum Length:
Minimum Occurrences: 0
Value range: *n/a*
Code table: *n/a*
Base type: int-i:LatentMatchingPositionType

Field ID: [02.077-A_02.077-B]
Condition: Optional
Defined in: xsd/int-i/1.0/int-i.xsd
Special Characters: *n/a*
Maximum Length:
Maximum Occurrences: 1
Regular Expression: *n/a*
Namespace: <http://interpol.int/int-i/1.0>

XPath

```

/itl:PackageDescriptiveTextRecord
├─ /itl:UserDefinedDescriptiveDetail
│   └─ /itl:DomainDefinedDescriptiveDetail
│       └─ /int-i:TransactionResponseData
│           └─ /int-i:LatentMatchingPosition
  
```

Summary

In case of an SRE transaction this optional field contains 2 subfields: the FGP Code of the matched finger, palm or latent and the FGP of the finger, palm or latent which caused the possible HIT.

Valid Examples

```

<int-i:LatentMatchingPosition>
  <int-i:LatentMatchingPositionSearch>11</int-i:LatentMatchingPositionSearch>
  <int-i:LatentMatchingPositionCandidate>13</int-i:LatentMatchingPositionCandidate>
</int-i:LatentMatchingPosition>
  
```

9.114. Latent Matching Position – Search - LMS

 LatentMatchingPositionSearch

Field Reference: 2/LMP/LMS
Content Type: Data_X
XML Tag Name: LatentMatchingPositionSearch
Data Type: N
Minimum Length: 1
Minimum Occurrences: 1
Value range: *n/a*
Code table: see table [A.25](#)
Base type: int-i:LatentMatchingPositionSimpleType

Field ID: [02.077-A]
Condition: Optional within a field
Defined in: xsd/int-i/1.0/int-i.xsd
Special Characters: *n/a*
Maximum Length: 2
Maximum Occurrences: 1
Regular Expression: \d{1,2}
Namespace: <http://interpol.int/int-i/1.0>

XPath

```
/itl:PackageDescriptiveTextRecord  
  ↙/itl:UserDefinedDescriptiveDetail  
    ↙/itl:DomainDefinedDescriptiveDetail  
      ↙/int-i:TransactionResponseData  
        ↙/int-i:LatentMatchingPosition  
          ↙/int-i:LatentMatchingPositionSearch
```

Summary

FGP of the matched finger, palm or latent

Notes

The position codes are given in table [A.25](#) in annex [A](#).

Valid Examples

```
<int-i:LatentMatchingPositionSearch>11</int-i:LatentMatchingPositionSearch>
```

9.115. Latent Matching Position – Candidate - LMC

 LatentMatchingPositionCandidate

Field Reference: 2/LMP/LMS-1
Content Type: Data_X
XML Tag Name: LatentMatchingPositionCandidate
Data Type: N
Minimum Length: 1
Minimum Occurrences: 1
Value range: *n/a*
Code table: see table [A.25](#)
Base type: int-i:LatentMatchingPositionSimpleType

Field ID: [02.077-A]
Condition: Optional within a field
Defined in: xsd/int-i/1.0/int-i.xsd
Special Characters: *n/a*
Maximum Length: 2
Maximum Occurrences: 1
Regular Expression: \d{1,2}
Namespace: <http://interpol.int/int-i/1.0>

XPath

```
/itl:PackageDescriptiveTextRecord  
  ↙/itl:UserDefinedDescriptiveDetail  
    ↙/itl:DomainDefinedDescriptiveDetail  
      ↙/int-i:TransactionResponseData  
        ↙/int-i:LatentMatchingPosition  
          ↙/int-i:LatentMatchingPositionCandidate
```

Summary

FGP of the finger, palm or latent that created the hit

Notes

The position codes are given in table [A.25](#) in annex [A](#).

Valid Examples

```
<int-i:LatentMatchingPositionCandidate>13</int-i:LatentMatchingPositionCandidate>
```

9.116. INTERPOL Reference Number - IRN

 InterpolReferenceNumber

Field Reference: 2/IRN
Content Type: Data_X
XML Tag Name: InterpolReferenceNumber
Data Type: ANS
Minimum Length: 1
Minimum Occurrences: 1
Value range: *n/a*
Code table: *n/a*
Base type: nc:TextType

Field ID: [02.090:X]
Condition: Optional
Defined in: xsd/int-i/1.0/int-i.xsd
Special Characters: *n/a*
Maximum Length: 32
Maximum Occurrences: 1
Regular Expression: *n/a*
Namespace: <http://interpol.int/int-i/1.0>

XPath

```
/itl:PackageDescriptiveTextRecord
├─ /itl:UserDefinedDescriptiveDetail
│   └─ /itl:DomainDefinedDescriptiveDetail
│       └─ /int-i:RecordMetadata
│           └─ /int-i:MiscellaneousIdentification
│               └─ /int-i:InterpolReferenceNumber
```

Summary

This field allows to transmit the INTERPOL reference number for the Person or the Latent.

Valid Examples

```
<int-i:InterpolReferenceNumber>01234567890A</int-i:InterpolReferenceNumber>
```

9.117. National Person Inquiry Identifier - NPI

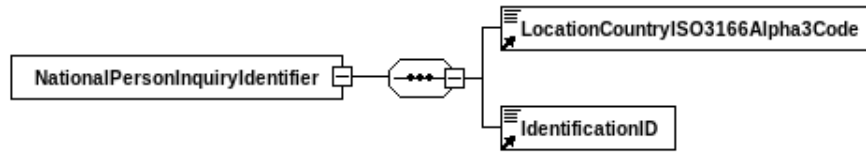

Field Reference: 2/NPI
Content Type: Set_X
XML Tag Name: NationalPersonInquiryIdentifier
Data Type:
Minimum Length:
Minimum Occurrences: 0
Value range: *n/a*
Code table: *n/a*
Base type: [int-i:NationalIdentifierType](#)

Field ID: [02.091:X]
Condition: Optional
Defined in: [xsd/int-i/1.0/int-i.xsd](#)
Special Characters: *n/a*
Maximum Length:
Maximum Occurrences: 1
Regular Expression: *n/a*
Namespace: <http://interpol.int/int-i/1.0>

XPath

```

/itl:PackageDescriptiveTextRecord
├── /itl:UserDefinedDescriptiveDetail
│   ├── /itl:DomainDefinedDescriptiveDetail
│   │   ├── /int-i:RecordMetadata
│   │   │   ├── /int-i:MiscellaneousIdentification
│   │   │   └── /int-i:NationalPersonInquiryIdentifier
  
```

Summary

This field allows to transmit the a temporary person reference number for the inquiry.

It has the same format as 2.010 (CRN) field, namely 2 subfields: a ISO3166 Alpha-3 country code identifying the country owning the Person, and the reference number itself.

Valid Examples

```

<int-i:NationalPersonInquiryIdentifier>
  <int-i:LocationCountryISO3166Alpha3Code>DEU</int-i:LocationCountryISO3166Alpha3Code>
  <nc:IdentificationID>0987654321</nc:IdentificationID>
</int-i:NationalPersonInquiryIdentifier>
  
```

9.118. Record Expiration Date - EXP

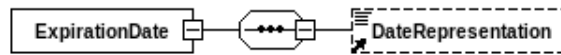

Field Reference: 2/EXP
Content Type: Data_X
XML Tag Name: ExpirationDate
Data Type: NS
Minimum Length: 10
Minimum Occurrences: 0
Value range: *n/a*
Code table: *n/a*
Base type: [niem-xsd:date](#)

Field ID: [02.092:X]
Condition: Optional
Defined in: [xsd/niem/niem-core/2.0/niem-core.xsd](#)
Special Characters: [-]
Maximum Length: 10
Maximum Occurrences: 1
Regular Expression: \d{4}-\d{2}-\d{2}
Namespace: <http://niem.gov/niem/niem-core/2.0>

XPath

```

/itl:PackageDescriptiveTextRecord
  ↙/itl:UserDefinedDescriptiveDetail
    ↙/itl:DomainDefinedDescriptiveDetail
      ↙/int-i:RecordMetadata
        ↙/nc:ExpirationDate
          ↙/nc:Date

```

Summary

If there is a known expiration date, this field gives the latest date when the record has to be deleted.

Notes

Even though the XSD would allow a `nc:DateTime` object in this field, the INTERPOL implementation only allows the use of a `nc:Date` element.

Valid Examples

```

<nc:ExpirationDate>
  <nc:Date>2027-07-11</nc:Date>
</nc:ExpirationDate>

```

Invalid Examples

```

<nc:ExpirationDate>
  <nc:DateTime>2027-07-11T12:00:00</nc:DateTime>
</nc:ExpirationDate>

```

9.119. Latent Unique Identifier - LID



Field Reference: 2/LID
Content Type: Data_X
XML Tag Name: LatentUniqueIdentifier
Data Type: ANS
Minimum Length: 1
Minimum Occurrences: 0
Value range: *n/a*
Code table: *n/a*
Base type: nc:TextType

Field ID: [02.093:X]
Condition: Optional
Defined in: xsd/int-i/1.0/int-i.xsd
Special Characters: [/.-]
Maximum Length: 128
Maximum Occurrences: 1
Regular Expression: *n/a*
Namespace: <http://interpol.int/int-i/1.0>

XPath

```
/itl:PackageDescriptiveTextRecord  
  ↳/itl:UserDefinedDescriptiveDetail  
    ↳/itl:DomainDefinedDescriptiveDetail  
      ↳/int-i:RecordMetadata  
        ↳/int-i:LatentUniqueIdentifier
```

Summary

This field is an optional unique reference identifier for the latent. It can be the concatenation of the case reference, evidence identifier and latent identifier, or any other identifier decided by the implementing country.

If specified in the request, it should be included in the response.

Valid Examples

```
<int-i:LatentUniqueIdentifier>001</int-i:LatentUniqueIdentifier>
```

9.120. Result Determination Mode - RDM

 **ResultDeterminationMode**

<p>Field Reference: 2/RDM Content Type: Data_X XML Tag Name: ResultDeterminationMode Data Type: A Minimum Length: 2 Minimum Occurrences: 0 Value range: <i>n/a</i> Code table: see table A.51 Base type: int-i:ResultDeterminationModeSimpleType</p>	<p>Field ID: [02.094:X] Condition: Optional Defined in: xsd/int-i/1.0/int-i.xsd Special Characters: <i>n/a</i> Maximum Length: 2 Maximum Occurrences: 1 Regular Expression: <i>n/a</i> Namespace: http://interpol.int/int-i/1.0</p>
---	--

XPath

```

/itl:PackageDescriptiveTextRecord
├─ /itl:UserDefinedDescriptiveDetail
│   └─ /itl:DomainDefinedDescriptiveDetail
│       └─ /int-i:TransactionMetadata
│           └─ /int-i:ResultDeterminationMode

```

Summary

As part of inquiry, indicates the type of processing and verification request; in a response indicates the processing and verification of any results.

Notes

If an inquiry has this element populated, any subsequent response should also include this element. Not all systems will include all modes; supported modes should be agreed between parties. Where only one mode or a default mode is agreed, this element can be omitted.

Valid Examples

```
<int-i:ResultDeterminationMode>C0</int-i:ResultDeterminationMode>
```

9.121. Civil Description Code - CRF

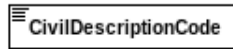

Field Reference: 2/CRF
Content Type: Data_X
XML Tag Name: CivilDescriptionCode
Data Type: A
Minimum Length: 2
Minimum Occurrences: 0
Value range: *n/a*
Code table: see table [A.7](#)
Base type: int-i:CivilDescriptionCodeType

Field ID: [02.095:X]
Condition: Optional
Defined in: xsd/int-i/1.0/int-i.xsd
Special Characters: *n/a*
Maximum Length: 3
Maximum Occurrences: 1
Regular Expression: *n/a*
Namespace: <http://interpol.int/int-i/1.0>

XPath

```
/itl:PackageDescriptiveTextRecord  
  ↳/itl:UserDefinedDescriptiveDetail  
    ↳/itl:DomainDefinedDescriptiveDetail  
      ↳/int-i:RecordCivil  
        ↳/int-i:CivilDescriptionCode
```

Summary

Reason for acquiring the fingerprints (Non-criminal acquisition)

Valid Examples

```
<int-i:CivilDescriptionCode>OTH</int-i:CivilDescriptionCode>
```

9.122. Civil Description Text - COT

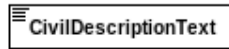

Field Reference: 2/COT
Content Type: Data_X
XML Tag Name: CivilDescriptionText
Data Type: U
Minimum Length: 1
Minimum Occurrences: 0
Value range: *n/a*
Code table: *n/a*
Base type: nc:TextType

Field ID: [02.096:X]
Condition: Dependent (see table)
Defined in: xsd/int-i/1.0/int-i.xsd
Special Characters: ALL
Maximum Length: *
Maximum Occurrences: 1
Regular Expression: *n/a*

Namespace: <http://interpol.int/int-i/1.0>

Dependency table	
Type of dependency	Value
Mandatory on Value of other Field, optional otherwise.	[2/RFP]="OTH"

XPath

```

/itl:PackageDescriptiveTextRecord
├─ /itl:UserDefinedDescriptiveDetail
│   └─ /itl:DomainDefinedDescriptiveDetail
│       └─ /int-i:RecordCivil
│           └─ /int-i:CivilDescriptionText
    
```

Summary

Description of the reason to acquire the fingerprint (Non-criminal acquisition)

Valid Examples

```
<int-i:CivilDescriptionText>VISA extension</int-i:CivilDescriptionText>
```

9.123. Field Mandatoriness in User-defined Descriptive Text Record

Depending on the context (especially on the type of transaction), the structure of the User-defined Descriptive Text will vary. The following table shows field by field, which ones are optional and which ones are mandatory, depending on the context.

Note that this table is just an overview: to know the exact conditions when each field is mandatory, optional, dependent... please refer to the field description page.

Table 9.1.: Field Summary for Type 2 Records

Field Ref	Description	ATP	CPS	NPS	MPS	SRE	ERR
2	Package Descriptive Text Record (XML)	O	O	O	O	O	O
2/XRCC:X	XML Record Category Code	M	M	M	M	M	M
2/IDC	Information Designation Character	M	M	M	M	M	M
2/UDF	User-Defined Fields	M	M	M	M	M	M
2/UDF:X1	Domain-Defined Fields	M	M	M	M	M	M
2/UDF:X1/RAC	Record Activity Fields	O	O	O	O	O	O
2/UDF:X1/RSU	Record Subject Fields	O	O	O	O	O	O
2/UDF:X1/ROF	Record Offence Fields	O	O		O		
2/UDF:X1/RCI	Record Civil Fields			O			
2/UDF:X1/RME	Record Metadata Fields	M	M	M	M	M	M
2/UDF:X1/TRD	Transaction Response Data Fields	O	O	O	O	M	O
2/UDF:X1/TMD	Transaction Metadata Fields	O	O	O	O	O	O
2/UDF:X2	Custom Defined Fields	O	O	O	O	O	O
2/DAR	Date of Record	O	O	O	O	O	O
2/DLU	Date of Last Update	O	O	O	O	O	O
2/CNO:X	Case Reference (XML)	O	O	O	O	M	O
2/CNO:X/CN1	Case Reference Country	M [^]	M [^]	M [^]	M [^]	M [^]	M [^]
2/CNO:X/CN2	Case Reference Identifier	M [^]	M [^]	M [^]	M [^]	M [^]	M [^]
2/SQN	Evidence Identifier	O	O	O	O	M	O
2/MID	Latent Identifier	O	O	O	O	M	O
2/CRN:X	Criminal Reference Number (XML)	O	O	O	O	M	O
2/CRN:X/CR1	Country Code of the Criminal Reference Number	M [^]	M [^]	M [^]	M [^]	M [^]	M [^]
2/CRN:X/CR2	Criminal Reference Number Value	M [^]	M [^]	M [^]	M [^]	M [^]	M [^]
2/ORN:X	Business Reference Number (XML)	O	O	O	O	M	O
2/ORN:X/OR1	Country Code of the Business Reference Number	M [^]	M [^]	M [^]	M [^]	M [^]	M [^]
2/ORN:X/OR2	Business Reference Number Value	M [^]	M [^]	M [^]	M [^]	M [^]	M [^]
2/MN1:X	Miscellaneous Identification Number 1 (XML)	O	O	O	O	O	O
2/MN1:X/MN1T	Miscellaneous Identification Number 1 (XML) – Type	O [^]	O [^]	O [^]	O [^]	O [^]	O [^]
2/MN1:X/MN1V	Miscellaneous Identification Number 1 (XML) – Value	M [^]	M [^]	M [^]	M [^]	M [^]	M [^]
2/MN2:X	Miscellaneous Identification Number 2 (XML)	O	O	O	O	O	O
2/MN2:X/MN2T	Miscellaneous Identification Number 2 (XML) – Type	O [^]	O [^]	O [^]	O [^]	O [^]	O [^]
2/MN2:X/MN2V	Miscellaneous Identification Number 2 (XML) – Value	M [^]	M [^]	M [^]	M [^]	M [^]	M [^]
2/MN3:X	Miscellaneous Identification Number 3 (XML)	O	O	O	O	O	O
2/MN3:X/MN3T	Miscellaneous Identification Number 3 (XML) – Type	O [^]	O [^]	O [^]	O [^]	O [^]	O [^]
2/MN3:X/MN3V	Miscellaneous Identification Number 3 (XML) – Value	M [^]	M [^]	M [^]	M [^]	M [^]	M [^]
2/MN4:X	Miscellaneous Identification Number 4 (XML)	O	O	O	O	O	O
2/MN4:X/MN4T	Miscellaneous Identification Number 4 (XML) – Type	O [^]	O [^]	O [^]	O [^]	O [^]	O [^]
2/MN4:X/MN4V	Miscellaneous Identification Number 4 (XML) – Value	M [^]	M [^]	M [^]	M [^]	M [^]	M [^]
2/MN5:X	Miscellaneous Identification Number 5 (XML)	O	O	O	O	O	O
2/MN5:X/MN5T	Miscellaneous Identification Number 5 (XML) – Type	O [^]	O [^]	O [^]	O [^]	O [^]	O [^]
2/MN5:X/MN5V	Miscellaneous Identification Number 5 (XML) – Value	M [^]	M [^]	M [^]	M [^]	M [^]	M [^]

M=Mandatory, O=Optional, M[^]=Mandatory Info Item within a Field, O[^]=Optional Info Item within a Field, Dmp=Mandatory if another field is present (not permitted otherwise), Dop=Optional and only permitted if another field is present, Doa=Optional and only permitted if another field is absent, Dmv=Mandatory (and not permitted otherwise) if another field has a given value, Ds=Special condition

9. User-defined Descriptive Text Record (aka Type 2)

Table 9.1.: Field Summary for Type 2 Records

Field Ref	Description	ATP	CPS	NPS	MPS	SRE	ERR
2/DPR:X	Date (and Time) Fingerprinted	O	O	O	O	O	O
2/RFP	Offence Description Code	O	O	O	O	O	O
2/POA:X	Place Of Arrest	O	O	O	O	O	O
2/POA/POA:X1	Place of Arrest (XML) – Free-text-form address	Doa	Doa	Doa	Doa	Doa	Doa
2/POA/POA:X2	Place of Arrest (XML) – Structured-form address	Doa	Doa	Doa	Doa	Doa	Doa
2/POA/POA:X2/PB1	Place of Arrest (XML) – Street number	O [^]	O [^]	O [^]	O [^]	O [^]	O [^]
2/POA/POA:X2/PB2	Place of Arrest (XML) – Street name	O [^]	O [^]	O [^]	O [^]	O [^]	O [^]
2/POA/POA:X2/PB3	Place of Arrest (XML) – City name	O [^]	O [^]	O [^]	O [^]	O [^]	O [^]
2/POA/POA:X2/PB4	Place of Arrest (XML) – County name	O [^]	O [^]	O [^]	O [^]	O [^]	O [^]
2/POA/POA:X2/PB5	Place of Arrest (XML) – State name	O [^]	O [^]	O [^]	O [^]	O [^]	O [^]
2/POA/POA:X2/PB6	Place of Arrest (XML) – Country code	M [^]	M [^]	M [^]	M [^]	M [^]	M [^]
2/POA/POA:X2/PB7	Place of Arrest (XML) – Postal code	O [^]	O [^]	O [^]	O [^]	O [^]	O [^]
2/OBU:X	Capture Organization Information (XML)	O	O	O	O	O	O
2/OBU/OBU:X1	Capture Organization Information (XML) – Organization Identification	O [^]	O [^]	O [^]	O [^]	O [^]	O [^]
2/OBU/OBU:X2	Capture Organization Information (XML) – Organization Name	O [^]	O [^]	O [^]	O [^]	O [^]	O [^]
2/OBU/OBU:X3	Capture Organization Information (XML) – Free-text-form address	O [^]	O [^]	O [^]	O [^]	O [^]	O [^]
2/OBU/OBU:X4	Capture Organization Information (XML) – Structured-form address	O [^]	O [^]	O [^]	O [^]	O [^]	O [^]
2/OBU/OBU:X4/OB1	Capture Organization Information (XML) – Street number	O [^]	O [^]	O [^]	O [^]	O [^]	O [^]
2/OBU/OBU:X4/OB2	Capture Organization Information (XML) – Street name	O [^]	O [^]	O [^]	O [^]	O [^]	O [^]
2/OBU/OBU:X4/OB3	Capture Organization Information (XML) – City name	O [^]	O [^]	O [^]	O [^]	O [^]	O [^]
2/OBU/OBU:X4/OB4	Capture Organization Information (XML) – County name	O [^]	O [^]	O [^]	O [^]	O [^]	O [^]
2/OBU/OBU:X4/OB5	Capture Organization Information (XML) – State name	O [^]	O [^]	O [^]	O [^]	O [^]	O [^]
2/OBU/OBU:X4/OB6	Capture Organization Information (XML) – Country code	O [^]	O [^]	O [^]	O [^]	O [^]	O [^]
2/OBU/OBU:X4/OB7	Capture Organization Information (XML) – Postal code	O [^]	O [^]	O [^]	O [^]	O [^]	O [^]
2/NAM:X	Name	M	O	O	O	O	O
2/NAM/NAM:X1	Person Prefix Name	O [^]	O [^]	O [^]	O [^]	O [^]	O [^]
2/NAM/NAM:X2	Person Given Name	Doa	Doa	Doa	Doa	Doa	Doa
2/NAM/NAM:X3	Person Middle Name	O [^]	O [^]	O [^]	O [^]	O [^]	O [^]
2/NAM/NAM:X4	Person Surname	Doa	Doa	Doa	Doa	Doa	Doa
2/NAM/NAM:X5	Person Suffix Name	O [^]	O [^]	O [^]	O [^]	O [^]	O [^]
2/NAM/NAM:X6	Person Maiden Name	O [^]	O [^]	O [^]	O [^]	O [^]	O [^]
2/NAM/NAM:X7	Person Extended Name	Doa	Doa	Doa	Doa	Doa	Doa
2/AKA	Aliases	O	O	O	O	O	O
2/DOB:X	Date of Birth (XML)	O	O	O	O	O	O
2/DBR:X	Date of Birth Range (XML)	O	O	O	O	O	O
2/DBR/SDA	Date of Birth Range (XML) - Min Date	M [^]	M [^]	M [^]	M [^]	M [^]	M [^]
2/DBR/EDA	Date of Birth Range (XML) - Max Date	M [^]	M [^]	M [^]	M [^]	M [^]	M [^]
2/POB:X	Place of Birth (XML)	O	O	O	O	O	O
2/POB/POB:X1	Place of Birth (XML) – Free text form	Doa	Doa	Doa	Doa	Doa	Doa
2/POB/POB:X2	Place of Birth (XML) – Structured address form	Doa	Doa	Doa	Doa	Doa	Doa
2/POB/POB:X2/PB1	Place of Birth (XML) – Street number	O [^]	O [^]	O [^]	O [^]	O [^]	O [^]
2/POB/POB:X2/PB2	Place of Birth (XML) – Street name	O [^]	O [^]	O [^]	O [^]	O [^]	O [^]
2/POB/POB:X2/PB3	Place of Birth (XML) – City name	O [^]	O [^]	O [^]	O [^]	O [^]	O [^]
2/POB/POB:X2/PB4	Place of Birth (XML) – County name	O [^]	O [^]	O [^]	O [^]	O [^]	O [^]
2/POB/POB:X2/PB5	Place of Birth (XML) – State name	O [^]	O [^]	O [^]	O [^]	O [^]	O [^]
2/POB/POB:X2/PB6	Place of Birth (XML) – Country code	M [^]	M [^]	M [^]	M [^]	M [^]	M [^]
2/POB/POB:X2/PB7	Place of Birth (XML) – Postal code	O [^]	O [^]	O [^]	O [^]	O [^]	O [^]
2/NAT	Nationality	M	O	O	O	O	O
2/SEX	Sex	O	O	O	O	O	O

M=Mandatory, O=Optional, M[^]=Mandatory Info Item within a Field, O[^]=Optional Info Item within a Field, Dmp=Mandatory if another field is present (not permitted otherwise), Dop=Optional and only permitted if another field is present, Doa=Optional and only permitted if another field is absent, Dmv=Mandatory (and not permitted otherwise) if another field has a given value, Ds=Special condition

9. User-defined Descriptive Text Record (aka Type 2)

Table 9.1.: Field Summary for Type 2 Records

Field Ref	Description	ATP	CPS	NPS	MPS	SRE	ERR
2/OTY:X	Offence Description Text	Dmv	Dmv	Dmv	Dmv	Dmv	Dmv
2/DOO:X	Date (and Time) of Offence (XML)	O	O	O	M	O	O
2/DOR:X	Date of Offence Range (XML)	O	O	O	M	O	O
2/DOR/SDA	Date (and Time) of Offence Range (XML) - Min Date	M [^]	M [^]	M [^]	M [^]	M [^]	M [^]
2/DOR/EDA	Date (and Time) of Offence Range (XML) - Max Date	M [^]	M [^]	M [^]	M [^]	M [^]	M [^]
2/INF:X	Additional Contact Information	O	O	O	O	O	O
2/INF/TEL	Telephone number for the additional contact information	O [^]	O [^]	O [^]	O [^]	O [^]	O [^]
2/INF/ONM	Organization name for the additional contact information	O [^]	O [^]	O [^]	O [^]	O [^]	O [^]
2/INF/PFN	Person full name for the additional contact information	O [^]	O [^]	O [^]	O [^]	O [^]	O [^]
2/INF/ACI	Additional information for the additional contact information	O [^]	O [^]	O [^]	O [^]	O [^]	O [^]
2/RLS:X	Respondent List (XML)	O	O	O	O	M	O
2/RLS/CSI	Candidate Sequence ID	Dmv	Dmv	Dmv	Dmv	Dmv	Dmv
2/RLS/MVI	Candidate Manual Verification Indicator	Dmv	Dmv	Dmv	Dmv	Dmv	Dmv
2/RLS/CTQ	Candidates Total Quantity	Dmv	Dmv	Dmv	Dmv	Dmv	Dmv
2/RLS/CAC	Transaction Category Code	M [^]	M [^]	M [^]	M [^]	M [^]	M [^]
2/RLS/SRC	Transaction Search Results Code	M [^]	M [^]	M [^]	M [^]	M [^]	M [^]
2/ERM:X	Error Message (XML)	O	O	O	O	O	M
2/ERM/ECO	Error code	M [^]	M [^]	M [^]	M [^]	M [^]	M [^]
2/ERM/EFM	Error Field Mnemonic Code	M [^]	M [^]	M [^]	M [^]	M [^]	M [^]
2/ERM/EMT	Error Message Text	M [^]	M [^]	M [^]	M [^]	M [^]	M [^]
2/FFN	Father's name	O	O	O	O	O	O
2/MMN	Mother's family name	O	O	O	O	O	O
2/LMP	Latent Matching Position	O	O	O	O	O	O
2/LMP/LMS	Latent Matching Position – Search	O [^]	O [^]	O [^]	O [^]	O [^]	O [^]
2/LMP/LMS	Latent Matching Position – Candidate	O [^]	O [^]	O [^]	O [^]	O [^]	O [^]
2/IRN	INTERPOL Reference Number	O	O	O	O	O	O
2/NPI	National Person Inquiry Identifier	O	O	O	O	O	O
2/EXP	Record Expiration Date	O	O	O	O	O	O
2/LID	Latent Unique Identifier	O	O	O	O	O	O
2/RDM	Result Determination Mode	O	O	O	O	O	O
2/CRF	Civil Description Code	O	O	O	O	O	O
2/COT	Civil Description Text	Dmv	Dmv	Dmv	Dmv	Dmv	Dmv

M=Mandatory, O=Optional, M[^]=Mandatory Info Item within a Field, O[^]=Optional Info Item within a Field, Dmp=Mandatory if another field is present (not permitted otherwise), Dop=Optional and only permitted if another field is present, Doa=Optional and only permitted if another field is absent, Dmv=Mandatory (and not permitted otherwise) if another field has a given value, Ds=Special condition

10. Minutiae Data Record (aka Type 9)

This chapter describes all the fields that are used in the Minutiae Data Record.

10.1. Package Minutiae Record (XML)

Field Reference: 9
Content Type: Set_X
XML Tag Name: PackageMinutiaeRecord
Data Type:
Minimum Length:
Minimum Occurrences: 0
Value range: *n/a*
Code table: *n/a*
Base type: itl:PackageMinutiaeRecordType

Field ID: [09]
Condition: Optional
Defined in: xsd/itl/2011/ITL-2007f-Package.xsd
Special Characters: *n/a*
Maximum Length:
Maximum Occurrences: *
Regular Expression: *n/a*
Namespace: <http://biometrics.nist.gov/standard/2011>

XPath

/itl:PackageMinutiaeRecord

Summary

Minutiae and related information encoded from a finger, palm, or plantar image.

10. Minutiae Data Record (aka Type 9)

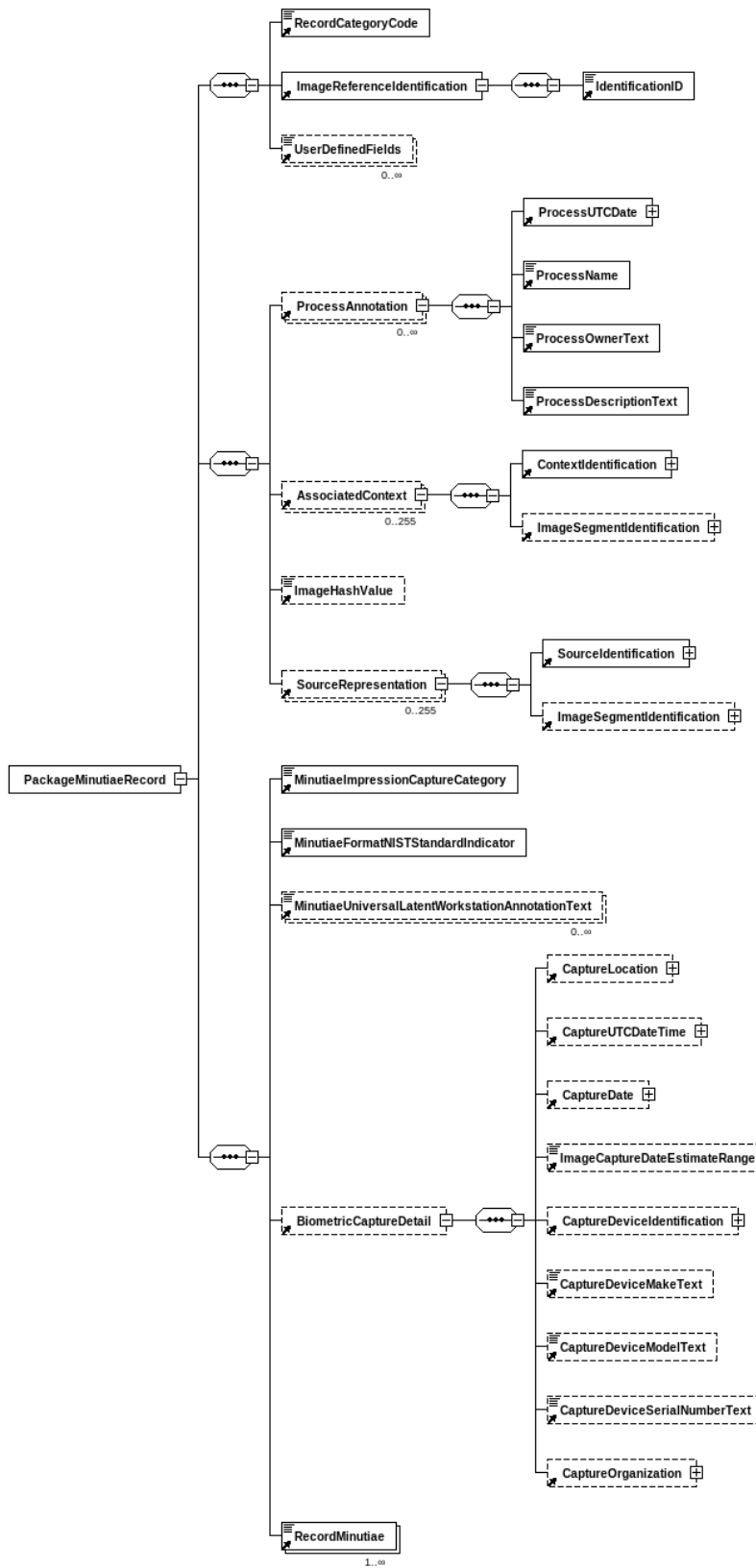

10.2. XML Record Category Code - XRCC

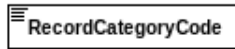

Field Reference: 9/XRCC:X
Content Type: Data_X
XML Tag Name: RecordCategoryCode
Data Type: N
Minimum Length: 1
Minimum Occurrences: 1
Value range: {9}
Code table: *n/a*
Base type: biom:RecordCategoryCodeType

Field ID: [09.001:X]
Condition: Mandatory
Defined in: xsd/niem/biometrics/1.0/biometrics.xsd
Special Characters: *n/a*
Maximum Length: 2
Maximum Occurrences: 1
Regular Expression: *n/a*
Namespace: <http://niem.gov/niem/biometrics/1.0>

XPath

```
/it1:PackageMinutiaeRecord  
  ↙/biom:RecordCategoryCode
```

Summary

Numeric representation of Record Type.

Valid Examples

```
<biom:RecordCategoryCode>9</biom:RecordCategoryCode>
```

10.3. Information Designation Character - IDC

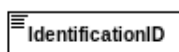

Field Reference: 9/IDC

Content Type: Data

XML Tag Name: IdentificationID

Data Type: N

Minimum Length: 1

Minimum Occurrences: 1

Value range: {0..99}

Code table: *n/a*

Base type: niem-xsd:string

Field ID: [09.002]

Condition: Mandatory

Defined in: xsd/niem/niem-core/2.0/niem-core.xsd

Special Characters: *n/a*

Maximum Length: 2

Maximum Occurrences: 1

Regular Expression: *n/a*

Namespace: <http://niem.gov/niem/niem-core/2.0>

XPath

```
/itl:PackageMinutiaeRecord
  ↙/biom:ImageReferenceIdentification
    ↙/nc:IdentificationID
```

Summary

IDC assigned in 1.003-D to this Type-9 record.

Valid Examples

```
<biom:ImageReferenceIdentification><nc:IdentificationID>3</nc:IdentificationID></biom:ImageReferenceIdentification>
```

10.4. Impression Type - IMP

 MinutiaeImpressionCaptureCategoryCode

Field Reference: 9/IMP	Field ID: [09.003]
Content Type: Data	Condition: Mandatory
XML Tag Name: MinutiaeImpressionCaptureCategoryCode	Defined in: xsd/niem/biometrics/1.0/biometrics.xsd
Data Type: N	Special Characters: <i>n/a</i>
Minimum Length: 1	Maximum Length: 2
Minimum Occurrences: 1	Maximum Occurrences: 1
Value range: <i>n/a</i>	Regular Expression: <i>n/a</i>
Code table: see table A.31	
Base type: biom:ImpressionCaptureCategoryCodeType	Namespace: http://niem.gov/niem/biometrics/1.0

XPath

```
/it1:PackageMinutiaeRecord  
  ↙/biom:MinutiaeImpressionCaptureCategoryCode
```

Summary

Manner by which friction ridge was obtained.

Valid Examples

<code><biom:MinutiaeImpressionCaptureCategoryCode>10</biom:MinutiaeImpressionCaptureCategoryCode></code>
--

10.5. Minutia Format (XML) - FMT

 MinutiaeFormatNISTStandardIndicator
--

Field Reference: 9/FMT:X

Content Type: Data_X

XML Tag Name: MinutiaeFormatNISTStandardIndicator

Data Type: A

Minimum Length: 1

Minimum Occurrences: 1

Value range: {"false"}

Code table: *n/a*

Base type: niem-xsd:boolean

Field ID: [09.004:X]

Condition: Mandatory

Defined in: xsd/niem/biometrics/1.0/biometrics.xsd

Special Characters: *n/a*

Maximum Length: 5

Maximum Occurrences: 1

Regular Expression: *n/a*

Namespace: <http://niem.gov/niem/biometrics/1.0>

XPath

```
/it1:PackageMinutiaeRecord
  ↙/biom:MinutiaeFormatNISTStandardIndicator
```

Summary

Indicates whether the information in the remainder of the record adheres to the standard format or is a user-defined format.

Notes

The deprecated standard minutiae format is not supported in INTERPOL's implementation, therefore only "false" is possible here.

Valid Examples

```
<biom:MinutiaeFormatNISTStandardIndicator>false<biom:MinutiaeFormatNISTStandardIndicator>
```

10.6. User-Defined Fields - RMU

Field Reference: 9/RMU:X	Field ID: [09.013_09.225:X]
Content Type: Set_X	Condition: Optional
XML Tag Name: RecordMinutiae	Defined in: xsd/niem/biometrics/1.0/biometrics.xsd
Data Type:	Special Characters: n/a
Minimum Length:	Maximum Length:
Minimum Occurrences: 0	Maximum Occurrences: *
Value range: n/a	Regular Expression: n/a
Code table: n/a	
Base type: n/a	Namespace: http://niem.gov/niem/biometrics/1.0

XPath

```
/it1:PackageMinutiaeRecord  
  ↪/biom:RecordMinutiae
```

Summary

The size and content of these fields shall be defined by the user and be in accordance with the receiving agency. Fields 9.180-9.225 shall be used to record specific vendor proprietary information regarding minutiae feature data.

Notes

This element is abstract and must be substituted with a user-defined element. Applies to the following groups of fields: 9.013-9.125, 9.151-9.175, 9.180-9.225.

10.7. INCITS Minutiae (XML)

Field Reference: 9/CBI_9/ADA
Content Type: Set_X
XML Tag Name: INCITSMinutiae
Data Type:
Minimum Length:
Minimum Occurrences: 0
Value range: *n/a*
Code table: *n/a*
Base type: biom:INCITSMinutiaeType

Field ID: [09.126_09.141]
Condition: Optional
Defined in: xsd/niem/biometrics/1.0/biometrics.xsd
Special Characters: *n/a*
Maximum Length:
Maximum Occurrences: *
Regular Expression: *n/a*
Namespace: <http://niem.gov/niem/biometrics/1.0>

XPath

```
/it1:PackageMinutiaeRecord  
  ↘/biom:INCITSMinutiae
```

Summary

Type-9 Fields for INCITS 378 features.

Notes

Applies to 9.126, 9.127, 9.128, 9.129, 9.130, 9.131, 9.132, 9.133, 9.134, 9.135, 9.137, 9.138, 9.139, 9.140 and 9.141.

10. Minutiae Data Record (aka Type 9)

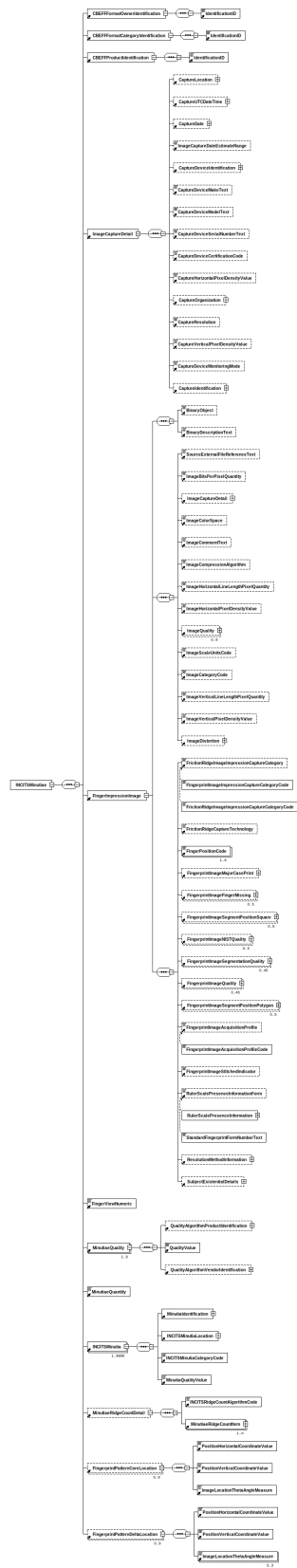

10.8. CBEFF Format Owner - CFO



Field Reference: 9/CBI/CFO
Content Type: Data
XML Tag Name: IdentificationID
Data Type: N
Minimum Length: 2
Minimum Occurrences: 1
Value range: {27}
Code table: *n/a*
Base type: niem-xsd:string

Field ID: [09.126-A]
Condition: Mandatory within a field
Defined in: xsd/niem/niem-core/2.0/niem-core.xsd
Special Characters: *n/a*
Maximum Length: 2
Maximum Occurrences: 1
Regular Expression: *n/a*

Namespace: <http://niem.gov/niem/niem-core/2.0>

Dependency table

Type of dependency	Value
Mandatory on Presence of other Field	9/CEI

XPath

```

/itl:PackageMinutiaeRecord
  ↳/biom:INCITSMinutiae
    ↳/biom:CBEFFFormatOwnerIdentification
      ↳/nc:IdentificationID
    
```

Summary

Identification assigned to the INCITS Technical Committee M1 by the International Biometric Industry Association (IBIA).

Valid Examples

```
<nc:IdentificationID>27</nc:IdentificationID>
```

10.9. CBEFF Format Type - CFT



Field Reference: 9/CBI/CFT
Content Type: Data
XML Tag Name: IdentificationID
Data Type: N
Minimum Length: 3
Minimum Occurrences: 1
Value range: {513..515}
Code table: *n/a*
Base type: niem-xsd:string

Field ID: [09.126-B]
Condition: Mandatory within a field
Defined in: xsd/niem/niem-core/2.0/niem-core.xsd
Special Characters: *n/a*
Maximum Length: 3
Maximum Occurrences: 1
Regular Expression: *n/a*

Namespace: <http://niem.gov/niem/niem-core/2.0>

XPath

```
/itl:PackageMinutiaeRecord  
  ↙/biom:INCITSMinutiae  
    ↙/biom:CBEFFFormatCategoryIdentification  
      ↙/nc:IdentificationID
```

Summary

CBEFF format features.

Technical Notes

"513" if 9.137 is present; "514" if 9.137, 9.138, 9.139, and 9.140 are present; "515" if INCITS 378-2009 is followed (does not indicate the presence or absence of any fields).

Valid Examples

```
<nc:IdentificationID>513</nc:IdentificationID>
```

10.10. CBEFF Product Identifier - CPI



Field Reference: 9/CBI/CPI
Content Type: Data
XML Tag Name: IdentificationID
Data Type: H
Minimum Length: 8
Minimum Occurrences: 1
Value range: *n/a*
Code table: *n/a*
Base type: niem-xsd:string

Field ID: [09.126-C]
Condition: Mandatory within a field
Defined in: xsd/niem/niem-core/2.0/niem-core.xsd
Special Characters: *n/a*
Maximum Length: 8
Maximum Occurrences: 1
Regular Expression: *n/a*

Namespace: <http://niem.gov/niem/niem-core/2.0>

XPath

```
/it1:PackageMinutiaeRecord  
  ↪/biom:INCITSMinutiae  
    ↪/biom:CBEFFProductIdentification  
      ↪/nc:IdentificationID
```

Summary

Owner of the encoding equipment.

Notes

Vendor sets this value at the IBIA website (www.ibia.org) if it is posted. If it is not posted, enter "0000".

Valid Examples

```
<nc:IdentificationID>001D</nc:IdentificationID>
```

10.11. M1 Capture Equipment ID - CEI

<p>Field Reference: 9/CEI Content Type: Set XML Tag Name: ImageCaptureDetail Data Type: Minimum Length: Minimum Occurrences: 0 Value range: <i>n/a</i> Code table: <i>n/a</i> Base type: biom:ImageCaptureType</p>	<p>Field ID: [09.127] Condition: Dependent (see table) Defined in: xsd/niem/biometrics/1.0/biometrics.xsd Special Characters: <i>n/a</i> Maximum Length: Maximum Occurrences: 1 Regular Expression: <i>n/a</i> Namespace: http://niem.gov/niem/biometrics/1.0</p>
---	--

Dependency table

Type of dependency	Value
Mandatory on Presence of other Field	9/CBI/CFO

XPath

```

/it1:PackageMinutiaeRecord
  ↳/biom:INCITSMinutiae
    ↳/biom:ImageCaptureDetail
    
```

Summary

Capture equipment information.

10. Minutiae Data Record (aka Type 9)



10.12. Appendix F Status - AFS

☰ CaptureDeviceCertificationCode

Field Reference: 9/CEI/AFS

Content Type: Data

XML Tag Name: CaptureDeviceCertificationCode

Data Type: A

Minimum Length: 4

Minimum Occurrences: 1

Value range: *n/a*

Code table: see table [A.5](#)

Base type: biom:CaptureDeviceCertificationCodeType

Field ID: [09.127-A]

Condition: Mandatory within a field

Defined in: xsd/niem/biometrics/1.0/biometrics.xsd

Special Characters: *n/a*

Maximum Length: 4

Maximum Occurrences: 1

Regular Expression: *n/a*

Namespace: <http://niem.gov/niem/biometrics/1.0>

XPath

```
/itl:PackageMinutiaeRecord
  ↙/biom:INCITSMinutiae
    ↙/biom:ImageCaptureDetail
      ↙/biom:CaptureDeviceCertificationCode
```

Summary

Notes whether or not equipment conforms to Appendix F specifications.

Valid Examples

<biom:CaptureDeviceCertificationCode>APPF</biom:CaptureDeviceCertificationCode>

10.13. Capture Equipment ID - CID

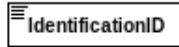

Field Reference: 9/CEI/CID
Content Type: Data
XML Tag Name: IdentificationID
Data Type: U
Minimum Length: 1
Minimum Occurrences: 1
Value range: *n/a*
Code table: *n/a*
Base type: niem-xsd:string

Field ID: [09.127-B]
Condition: Mandatory within a field
Defined in: xsd/niem/niem-core/2.0/niem-core.xsd
Special Characters: *n/a*
Maximum Length: 30
Maximum Occurrences: 1
Regular Expression: *n/a*

Namespace: <http://niem.gov/niem/niem-core/2.0>

XPath

```
/itl:PackageMinutiaeRecord  
  ↳/biom:INCITSMinutiae  
    ↳/biom:ImageCaptureDetail  
      ↳/biom:CaptureDeviceIdentification  
        ↳/nc:IdentificationID
```

Summary

Vendor-assigned product number/identifier of capture equipment.

Notes

A value of "0" indicates that the capture equipment ID is unreported.

Valid Examples

```
<nc:IdentificationID>0</nc:IdentificationID>
```

10.14. Finger Impression Image (XML)

Field Reference: 9/HLL_9/FGP

Content Type: Set_X

XML Tag Name: FingerImpressionImage

Data Type:

Minimum Length:

Minimum Occurrences: 1

Value range: *n/a*

Code table: *n/a*

Base type: biom:FingerImpressionImageType

Field ID: [09.128_09.134]

Condition: Mandatory

Defined in: xsd/niem/biometrics/1.0/biometrics.xsd

Special Characters: *n/a*

Maximum Length:

Maximum Occurrences: 1

Regular Expression: *n/a*

Namespace: <http://niem.gov/niem/biometrics/1.0>

XPath

```
/it1:PackageMinutiaeRecord
  ↳/biom:INCITSMinutiae
    ↳/biom:FingerImpressionImage
```

Summary

Finger impression image.

Notes

Applies to 9.128, 9.129, 9.130, 9.131, 9.132 and 9.134 .

10. Minutiae Data Record (aka Type 9)

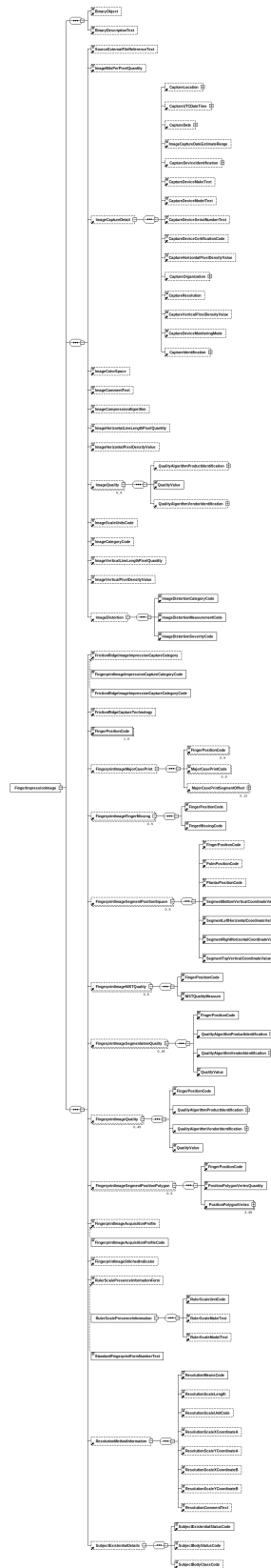

10.15. M1 Horizontal Line Length - HLL

ImageHorizontalLineLengthPixelQuantity

<p>Field Reference: 9/HLL Content Type: Data XML Tag Name: ImageHorizontalLineLengthPixelQuantity Data Type: N Minimum Length: 2 Minimum Occurrences: 0 Value range: {10..99999} Code table: n/a Base type: niem-xsd:integer</p>	<p>Field ID: [09.128] Condition: Dependent (see table) Defined in: xsd/niem/biometrics/1.0/biometrics.xsd Special Characters: n/a Maximum Length: 5 Maximum Occurrences: 1 Regular Expression: n/a Namespace: http://niem.gov/niem/biometrics/1.0</p>
---	--

Dependency table

Type of dependency	Value
Mandatory on Presence of other Field	9/CBI/CFO

XPath

```
/itl:PackageMinutiaeRecord
  ↙/biom:INCITSMinutiae
    ↙/biom:FingerImpressionImage
      ↙/biom:ImageHorizontalLineLengthPixelQuantity
```

Summary

Number of pixels contained on a single horizontal line of the image.

Valid Examples

<biom:ImageHorizontalLineLengthPixelQuantity>80</biom:ImageHorizontalLineLengthPixelQuantity>

10.16. M1 Vertical Line Length - VLL

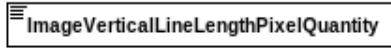

Field Reference: 9/VLL	Field ID: [09.129]
Content Type: Data	Condition: Dependent (see table)
XML Tag Name: ImageVerticalLineLengthPixelQuantity	Defined in: xsd/niem/biometrics/1.0/biometrics.xsd
Data Type: N	Special Characters: <i>n/a</i>
Minimum Length: 2	Maximum Length: 5
Minimum Occurrences: 0	Maximum Occurrences: 1
Value range: {10..99999}	Regular Expression: <i>n/a</i>
Code table: <i>n/a</i>	
Base type: niem-xsd:integer	Namespace: http://niem.gov/niem/biometrics/1.0

Dependency table

Type of dependency	Value
Mandatory on Presence of other Field	9/CBI/CFO

XPath

```

/itl:PackageMinutiaeRecord
  ↙/biom:INCITSMinutiae
    ↙/biom:FingerImpressionImage
      ↙/biom:ImageVerticalLineLengthPixelQuantity
    
```

Summary

Number of pixels contained on a single vertical line of the image (or number of horizontal lines contained in the transmitted image).

Valid Examples

```
<biom:ImageVerticalLineLengthPixelQuantity>65</biom:ImageVerticalLineLengthPixelQuantity>
```

10.17. M1 Scale Units - SLC

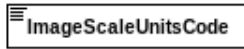

Field Reference: 9/SLC	Field ID: [09.130]
Content Type: Data	Condition: Dependent (see table)
XML Tag Name: ImageScaleUnitsCode	Defined in: xsd/niem/biometrics/1.0/biometrics.xsd
Data Type: N	Special Characters: <i>n/a</i>
Minimum Length: 1	Maximum Length: 1
Minimum Occurrences: 0	Maximum Occurrences: 1
Value range: <i>n/a</i>	Regular Expression: <i>n/a</i>
Code table: see table A.59	
Base type: biom:ScaleUnitsCodeType	Namespace: http://niem.gov/niem/biometrics/1.0

Dependency table

Type of dependency	Value
Mandatory on Presence of other Field	9/CBI/CFO

XPath

```
/itl:PackageMinutiaeRecord
  ↳/biom:INCITSMinutiae
    ↳/biom:FingerImpressionImage
      ↳/biom:ImageScaleUnitsCode
```

Summary

Image sampling frequency (pixel density).

Notes

For contact exemplar friction ridge images, a value of 1 or 2 shall be specified. A value of 1 or 2 shall be specified for latent friction ridge prints if the lifted latent print is transmitted directly from a scanner. If the latent print is contained in a photograph, a value of 1 or 2 shall be entered only if the image of the latent was captured with a scale measurement visible in the image and the pixels across an inch or centimeter can be calculated - given the known characteristics of the camera and its distance from the latent print. A value of 0 for a latent print indicates that the true ppi value of the image is not known. For non-contact images of body parts, SLC shall be set to 0 unless the object being imaged is a fixed distance from the capture device and the ppi or ppm values for the capture device are accurately known at that fixed distance. (An example might be an iris capture device with a very small effective capture zone).

Valid Examples

```
<biom:ImageScaleUnitsCode>2</biom:ImageScaleUnitsCode>
```

10.18. M1 Transmitted Horizontal Pixel Scale - THPS

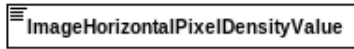

Field Reference: 9/THPS	Field ID: [09.131]
Content Type: Data	Condition: Dependent (see table)
XML Tag Name: ImageHorizontalPixelDensityValue	Defined in: xsd/niem/biometrics/1.0/biometrics.xsd
Data Type: N	Special Characters: <i>n/a</i>
Minimum Length: 1	Maximum Length: 5
Minimum Occurrences: 0	Maximum Occurrences: 1
Value range: <i>n/a</i>	Regular Expression: <i>n/a</i>
Code table: <i>n/a</i>	
Base type: niem-xsd:nonNegativeInteger	Namespace: http://niem.gov/niem/biometrics/1.0

Dependency table

Type of dependency	Value
Mandatory on Presence of other Field	9/CBI/CFO

XPath

```

/itl:PackageMinutiaeRecord
  ↙/biom:INCITSMinutiae
    ↙/biom:FingerImpressionImage
      ↙/biom:ImageHorizontalPixelDensityValue
    
```

Summary

Integer pixel density in the horizontal direction (if 9/SLC = 1 or 2); otherwise, if 9/SLC = 0, the horizontal component of the pixel aspect ratio.

Notes

For example, if the SLC value = 1, then the value of THPS could be '1000' for a 1000 ppi sensor.

Technical Notes

If 9/SLC=1,2, then THPS shall equal TVPS

Valid Examples

```
<biom:ImageHorizontalPixelDensityValue>1000</biom:ImageHorizontalPixelDensityValue>
```

10.19. M1 Transmitted Vertical Pixel Scale - TVPS

ImageVerticalPixelDensityValue

Field Reference: 9/TVPS

Content Type: Data

XML Tag Name: ImageVerticalPixelDensityValue

Data Type: N

Minimum Length: 1

Minimum Occurrences: 0

Value range: *n/a*

Code table: *n/a*

Base type: niem-xsd:nonNegativeInteger

Field ID: [09.132]

Condition: Dependent (see table)

Defined in: xsd/niem/biometrics/1.0/biometrics.xsd

Special Characters: *n/a*

Maximum Length: 5

Maximum Occurrences: 1

Regular Expression: *n/a*

Namespace: <http://niem.gov/niem/biometrics/1.0>

Dependency table

Type of dependency	Value
Mandatory on Presence of other Field	9/CBI/CFO

XPath

```
/it1:PackageMinutiaeRecord
  ↳/biom:INCITSM minutiae
    ↳/biom:FingerImpressionImage
      ↳/biom:ImageVerticalPixelDensityValue
```

Summary

Integer pixel density in the vertical direction (if 9/SLC = 1 or 2); otherwise, if 9/SLC = 0, the vertical component of the pixel aspect ratio.

Technical Notes

If 9/SLC=1,2, then THPS shall equal TVPS

Valid Examples

```
<biom:ImageVerticalPixelDensityValue>1000</biom:ImageVerticalPixelDensityValue>
```

10.20. M1 Finger View - FWV

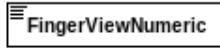

Field Reference: 9/FVW	Field ID: [09.133]
Content Type: Data	Condition: Dependent (see table)
XML Tag Name: FingerViewNumeric	Defined in: xsd/niem/biometrics/1.0/biometrics.xsd
Data Type: N	Special Characters: <i>n/a</i>
Minimum Length: 1	Maximum Length: 2
Minimum Occurrences: 0	Maximum Occurrences: 1
Value range: {0..15}	Regular Expression: <i>n/a</i>
Code table: <i>n/a</i>	
Base type: biom:FingerViewNumericType	Namespace: http://niem.gov/niem/biometrics/1.0

Dependency table

Type of dependency	Value
Mandatory on Presence of other Field	9/CBI/CFO

XPath

```
/itl:PackageMinutiaeRecord
  ↳/biom:INCITSMinutiae
    ↳/biom:FingerViewNumeric
```

Summary

View number of the finger associated with this record's data; used to differentiate multiple images of the same finger. The view number begins with "0" and increments by one to "15".

Valid Examples

```
<biom:FingerViewNumeric>8</biom:FingerViewNumeric>
```

10.21. M1 Friction Ridge Generalized Position - FGP

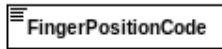

<p>Field Reference: 9/FGP Content Type: Data XML Tag Name: FingerPositionCode Data Type: N Minimum Length: 1 Minimum Occurrences: 0 Value range: {0..10,20..28} Code table: see table A.25 and table A.26 Base type: biom:FingerPositionCodeType</p>	<p>Field ID: [09.134] Condition: Dependent (see table) Defined in: xsd/niem/biometrics/1.0/biometrics.xsd Special Characters: <i>n/a</i> Maximum Length: 2 Maximum Occurrences: 6 Regular Expression: <i>n/a</i> Namespace: http://niem.gov/niem/biometrics/1.0</p>
---	--

Dependency table

Type of dependency	Value
Mandatory on Presence of other Field	9/CBI/CFO

XPath

```
/it1:PackageMinutiaeRecord
  ↙/biom:INCITSMinutiae
    ↙/biom:FingerImpressionImage
      ↙/biom:FingerPositionCode
```

Summary

Finger position that produced information in this Type-9 record.

Valid Examples

```
<biom:FingerPositionCode>5</biom:FingerPositionCode>
```

10.22. M1 Friction Ridge Quality Data - FQD

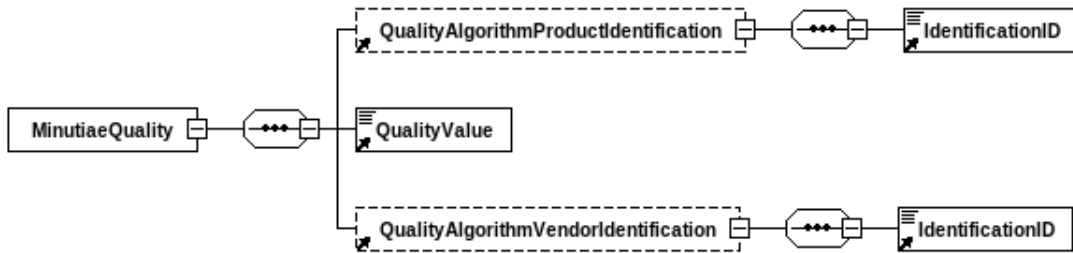

Field Reference: 9/FQD
Content Type: Set
XML Tag Name: MinutiaeQuality
Data Type:
Minimum Length:
Minimum Occurrences: 0
Value range: *n/a*
Code table: *n/a*
Base type: biom:ImageQualityType

Field ID: [09.135]
Condition: Dependent (see table)
Defined in: xsd/niem/biometrics/1.0/biometrics.xsd
Special Characters: *n/a*
Maximum Length:
Maximum Occurrences: 9
Regular Expression: *n/a*
Namespace: <http://niem.gov/niem/biometrics/1.0>

Dependency table

Type of dependency	Value
Mandatory on Presence of other Field	9/CBI/CFO

XPath

```

/itl:PackageMinutiaeRecord
  ↳/biom:INCITSMinutiae
    ↳/biom:MinutiaeQuality
    
```

Summary

Quality of overall finger minutiae data.

10.23. Quality Value - QVU

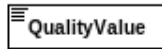

Field Reference: 9/FQD/QVU
Content Type: Data
XML Tag Name: QualityValue
Data Type: N
Minimum Length: 1
Minimum Occurrences: 1
Value range: {0..100,254,255}
Code table: see table A.48 *
Base type: niem-xsd:integer

Field ID: [09.135-A]
Condition: Mandatory within a field
Defined in: xsd/niem/biometrics/1.0/biometrics.xsd
Special Characters: *n/a*
Maximum Length: 3
Maximum Occurrences: 1
Regular Expression: *n/a*

Namespace: <http://niem.gov/niem/biometrics/1.0>

XPath

```

/itl:PackageMinutiaeRecord
└─/biom:INCITSMinutiae
  └─/biom:MinutiaeQuality
    └─/biom:QualityValue
  
```

Summary

Quantitative expression of predicted matching performance of biometric sample. This information item shall contain the integer image quality score between 0 and 100 (inclusive) assigned to the image data by a quality algorithm. Higher values indicate better quality.

Valid Examples

```
<biom:QualityValue>100</biom:QualityValue>
```

*The code table is optional, defining commonly-used or special-purpose values, rather than definitive (listing all possible values).

10.24. Algorithm Vendor Identification - QAV

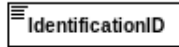

Field Reference: 9/FQD/QAV
Content Type: Data
XML Tag Name: IdentificationID
Data Type: H
Minimum Length: 4
Minimum Occurrences: 0
Value range: *n/a*
Code table: *n/a*
Base type: niem-xsd:string

Field ID: [09.135-B]
Condition: Optional within a field
Defined in: xsd/niem/niem-core/2.0/niem-core.xsd
Special Characters: *n/a*
Maximum Length: 4
Maximum Occurrences: 1
Regular Expression: *n/a*

Namespace: <http://niem.gov/niem/niem-core/2.0>

XPath

```

/itl:PackageMinutiaeRecord
  ↳/biom:INCITSMinutiae
    ↳/biom:MinutiaeQuality
      ↳/biom:QualityAlgorithmVendorIdentification
        ↳/nc:IdentificationID
  
```

Summary

ID of the vendor of the quality algorithm used to calculate the quality score. This value is assigned by IBIA, which maintains the Vendor Registry of CBEFF Biometric Organizations that map the value in this field to a registered organization.

Valid Examples

```
<nc:IdentificationID>FFF0</nc:IdentificationID>
```

10.25. Algorithm Product Identification - QAP

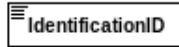

Field Reference: 9/FQD/QAP
Content Type: Data
XML Tag Name: IdentificationID
Data Type: N
Minimum Length: 1
Minimum Occurrences: 0
Value range: {1..65535}
Code table: *n/a*
Base type: niem-xsd:string

Field ID: [09.135-C]
Condition: Optional within a field
Defined in: xsd/niem/niem-core/2.0/niem-core.xsd
Special Characters: *n/a*
Maximum Length: 5
Maximum Occurrences: 1
Regular Expression: *n/a*

Namespace: <http://niem.gov/niem/niem-core/2.0>

XPath

```

/itl:PackageMinutiaeRecord
  ↳/biom:INCITSMinutiae
    ↳/biom:MinutiaeQuality
      ↳/biom:QualityAlgorithmProductIdentification
        ↳/nc:IdentificationID
  
```

Summary

Numeric product code assigned by the vendor of the quality algorithm (may be registered with the IBIA, but registration is not required).

Valid Examples

```
<nc:IdentificationID>28495</nc:IdentificationID>
```

10.26. M1 Number of Minutiae - NOM

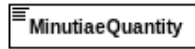

Field Reference: 9/NOM	Field ID: [09.136]
Content Type: Data	Condition: Dependent (see table)
XML Tag Name: MinutiaeQuantity	Defined in: xsd/niem/biometrics/1.0/biometrics.xsd
Data Type: N	Special Characters: <i>n/a</i>
Minimum Length: 1	Maximum Length: 4
Minimum Occurrences: 0	Maximum Occurrences: 1
Value range: {1..9999}	Regular Expression: <i>n/a</i>
Code table: <i>n/a</i>	
Base type: niem-xsd:nonNegativeInteger	Namespace: http://niem.gov/niem/biometrics/1.0

Dependency table

Type of dependency	Value
Mandatory on Presence of other Field	9/CBI/CFO

XPath

```
/it1:PackageMinutiaeRecord
  ↳/biom:INCITSMinutiae
    ↳/biom:MinutiaeQuantity
```

Summary

Number of minutiae in INCITS feature set.

Valid Examples

```
<biom:MinutiaeQuantity>50</biom:MinutiaeQuantity>
```

10.27. M1 Finger Minutiae Data (XML) - FMD

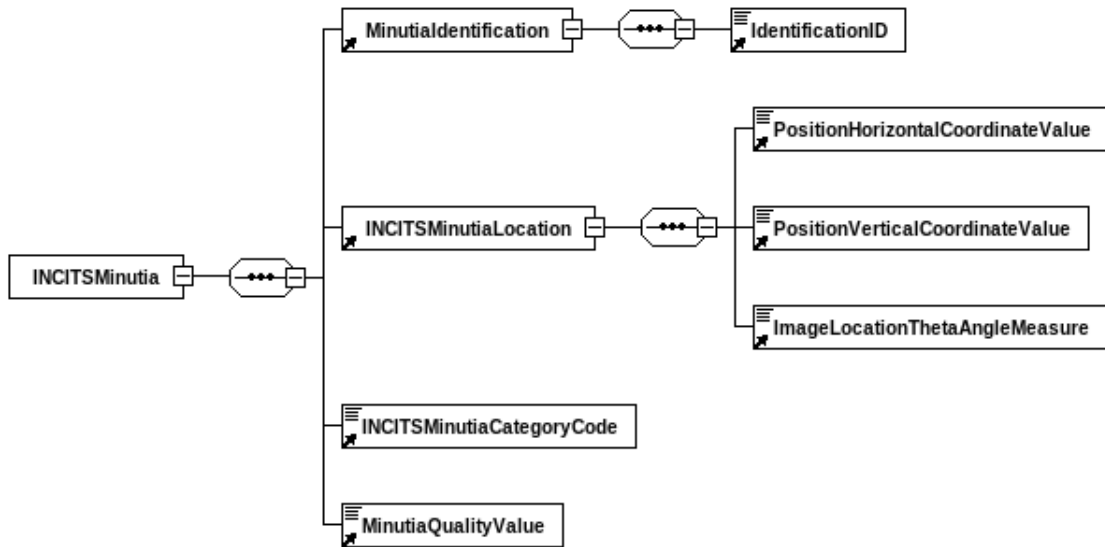

Field Reference: 9/FMD:X
Content Type: Set_X
XML Tag Name: INCITSMinutia
Data Type:
Minimum Length:
Minimum Occurrences: 0
Value range: *n/a*
Code table: *n/a*
Base type: biom:INCITSMinutiaType

Field ID: [09.137:X]
Condition: Dependent (see table)
Defined in: xsd/niem/biometrics/1.0/biometrics.xsd
Special Characters: *n/a*
Maximum Length:
Maximum Occurrences: *
Regular Expression: *n/a*
Namespace: <http://niem.gov/niem/biometrics/1.0>

Dependency table

Type of dependency	Value
Mandatory on Presence of other Field	9/CBI/CFO

XPath

```

/itl:PackageMinutiaeRecord
  ↙/biom:INCITSMinutiae
    ↙/biom:INCITSMinutia
  
```

Summary

Finger minutiae data.

Notes

The total number of minutiae subfields must agree with the count found in field 136.

10.28. Minutia Index Number - MAN



Field Reference: 9/FMD/MAN
Content Type: Data
XML Tag Name: IdentificationID
Data Type: N
Minimum Length: 1
Minimum Occurrences: 1
Value range: {>=1}
Code table: *n/a*
Base type: niem-xsd:string

Field ID: [09.137-A]
Condition: Mandatory within a field
Defined in: xsd/niem/niem-core/2.0/niem-core.xsd
Special Characters: *n/a*
Maximum Length: 4
Maximum Occurrences: 1
Regular Expression: *n/a*
Namespace: <http://niem.gov/niem/niem-core/2.0>

XPath

```
/itl:PackageMinutiaeRecord  
  ↳/biom:INCITSMinutiae  
    ↳/biom:INCITSMinutia  
      ↳/biom:MinutiaIdentification  
        ↳/nc:IdentificationID
```

Summary

Minutia index number; initialized to "1" and incremented by "1" for each additional minutia in the fingerprint.

Valid Examples

```
<nc:IdentificationID>51</nc:IdentificationID>
```

10.29. INCITS Minutia Location (XML)

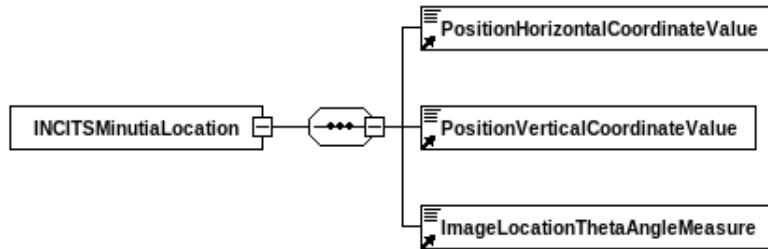

Field Reference: 9/FMD/MXC_9/FMD/MAV
Content Type: Set_X
XML Tag Name: INCITSMinutiaLocation
Data Type:
Minimum Length:
Minimum Occurrences: 1
Value range: *n/a*
Code table: *n/a*
Base type: biom:FingerprintFeatureLocationType

Field ID: [09.137-B_09.137-D]
Condition: Mandatory
Defined in: xsd/niem/biometrics/1.0/biometrics.xsd
Special Characters: *n/a*
Maximum Length:
Maximum Occurrences: 1
Regular Expression: *n/a*
Namespace: <http://niem.gov/niem/biometrics/1.0>

XPath

```

/it1:PackageMinutiaeRecord
  ↳/biom:INCITSMinutiae
    ↳/biom:INCITSMinutia
      ↳/biom:INCITSMinutiaLocation
  
```

Summary

Minutia index number.

Notes

Applies to 9.137-B, 9.137-C, and 9.137-D

10.30. X Coordinate - MXC

 PositionHorizontalCoordinateValue

Field Reference: 9/FMD/MXC

Content Type: Data

XML Tag Name: PositionHorizontalCoordinateValue

Data Type: N

Minimum Length: 1

Minimum Occurrences: 1

Value range: {>=1}

Code table: *n/a*

Base type: niem-xsd:nonNegativeInteger

Field ID: [09.137-B]

Condition: Mandatory within a field

Defined in: xsd/niem/biometrics/1.0/biometrics.xsd

Special Characters: *n/a*

Maximum Length: 5

Maximum Occurrences: 1

Regular Expression: *n/a*

Namespace: <http://niem.gov/niem/biometrics/1.0>

XPath

```
/itl:PackageMinutiaeRecord
  ↳/biom:INCITSMinutiae
    ↳/biom:INCITSMinutia
      ↳/biom:INCITSMinutiaLocation
        ↳/biom:PositionHorizontalCoordinateValue
```

Summary

X coordinate of minutia (expressed in pixel units).

Valid Examples

```
<biom:PositionHorizontalCoordinateValue>25643</biom:PositionHorizontalCoordinateValue>
```

10.31. Y Coordinate - MYC

 PositionVerticalCoordinateValue

Field Reference: 9/FMD/MYC

Content Type: Data

XML Tag Name: PositionVerticalCoordinateValue

Data Type: N

Minimum Length: 1

Minimum Occurrences: 1

Value range: {>=1}

Code table: *n/a*

Base type: niem-xsd:nonNegativeInteger

Field ID: [09.137-C]

Condition: Mandatory within a field

Defined in: xsd/niem/biometrics/1.0/biometrics.xsd

Special Characters: *n/a*

Maximum Length: 5

Maximum Occurrences: 1

Regular Expression: *n/a*

Namespace: <http://niem.gov/niem/biometrics/1.0>

XPath

```
/itl:PackageMinutiaeRecord
  ↳/biom:INCITSMinutiae
    ↳/biom:INCITSMinutia
      ↳/biom:INCITSMinutiaLocation
        ↳/biom:PositionVerticalCoordinateValue
```

Summary

Y coordinate of minutia (expressed in pixel units).

Valid Examples

<code><biom:PositionVerticalCoordinateValue>35681</biom:PositionVerticalCoordinateValue></code>

10.32. Minutia Angle - MAV

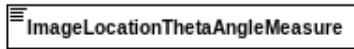

Field Reference: 9/FMD/MAV
Content Type: Data
XML Tag Name: ImageLocationThetaAngleMeasure
Data Type: N
Minimum Length: 1
Minimum Occurrences: 1
Value range: {0..179}
Code table: *n/a*
Base type: biom:ThetaAngleMeasureType

Field ID: [09.137-D]
Condition: Mandatory within a field
Defined in: xsd/niem/biometrics/1.0/biometrics.xsd
Special Characters: *n/a*
Maximum Length: 3
Maximum Occurrences: 1
Regular Expression: *n/a*
Namespace: <http://niem.gov/niem/biometrics/1.0>

XPath

```
/itl:PackageMinutiaeRecord  
  ↙/biom:INCITSMinutiae  
    ↙/biom:INCITSMinutia  
      ↙/biom:INCITSMinutiaLocation  
        ↙/biom:ImageLocationThetaAngleMeasure
```

Summary

Angle of minutia.

Valid Examples

```
<biom:ImageLocationThetaAngleMeasure>101</biom:ImageLocationThetaAngleMeasure>
```

10.33. Minutia Type - M1M

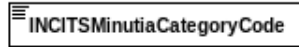

Field Reference: 9/FMD/M1M
Content Type: Data
XML Tag Name: INCITSMinutiaCategoryCode
Data Type: N
Minimum Length: 1
Minimum Occurrences: 1
Value range: *n/a*
Code table: see table [A.27](#)
Base type: biom:INCITSMinutiaCategoryCodeType

Field ID: [09.137-E]
Condition: Mandatory within a field
Defined in: xsd/niem/biometrics/1.0/biometrics.xsd
Special Characters: *n/a*
Maximum Length: 1
Maximum Occurrences: 1
Regular Expression: *n/a*
Namespace: <http://niem.gov/niem/biometrics/1.0>

XPath

```
/itl:PackageMinutiaeRecord  
  ↙/biom:INCITSMinutiae  
    ↙/biom:INCITSMinutia  
      ↙/biom:INCITSMinutiaCategoryCode
```

Summary

Type of minutia.

Valid Examples

```
<biom:INCITSMinutiaCategoryCode>0</biom:INCITSMinutiaCategoryCode>
```

10.34. Quality of Minutia - QOM

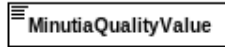

Field Reference: 9/FMD/QOM
Content Type: Data
XML Tag Name: MinutiaQualityValue
Data Type: N
Minimum Length: 1
Minimum Occurrences: 1
Value range: {0..100}
Code table: see table A.28 *
Base type: niem-xsd:nonNegativeInteger

Field ID: [09.137-F]
Condition: Mandatory within a field
Defined in: xsd/niem/biometrics/1.0/biometrics.xsd
Special Characters: *n/a*
Maximum Length: 3
Maximum Occurrences: 1
Regular Expression: *n/a*
Namespace: <http://niem.gov/niem/biometrics/1.0>

XPath

```
/it1:PackageMinutiaeRecord  
  ↙/biom:INCITSMinutiae  
    ↙/biom:INCITSMinutia  
      ↙/biom:MinutiaQualityValue
```

Summary

Minutia quality.

Valid Examples

```
<biom:MinutiaQualityValue>99</biom:MinutiaQualityValue>
```

*The code table is optional, defining commonly-used or special-purpose values, rather than definitive (listing all possible values).

10.35. M1 Ridge Count Information - RCI

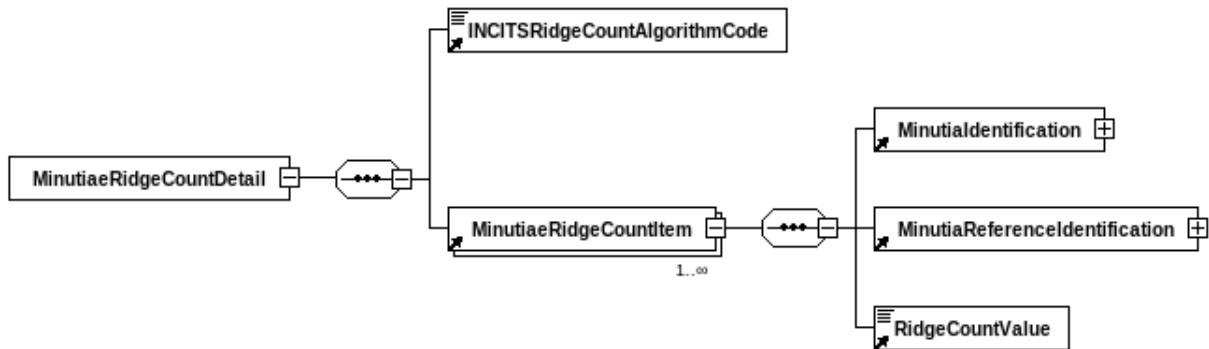

Field Reference: 9/RCI
 Content Type: Set
 XML Tag Name: MinutiaeRidgeCountDetail
 Data Type:
 Minimum Length:
 Minimum Occurrences: 0
 Value range: *n/a*
 Code table: *n/a*
 Base type: biom:MinutiaeRidgeCountType

Field ID: [09.138]
 Condition: Dependent (see table)
 Defined in: xsd/niem/biometrics/1.0/biometrics.xsd
 Special Characters: *n/a*
 Maximum Length:
 Maximum Occurrences: 79993
 Regular Expression: *n/a*
 Namespace: <http://niem.gov/niem/biometrics/1.0>

Dependency table

Type of dependency	Value
Optional on Value of other Field, should not be set otherwise.	[9/CBI/CFT]IN{514,515}

XPath

```
/itl:PackageMinutiaeRecord
  ↙/biom:INCITSMinutiae
    ↙/biom:MinutiaeRidgeCountDetail
```

Summary

Ridge count information.

Notes

MaxOccur = 9999 * 8 + 1 (9999=max occurrence of 9/NOM)

10.36. Ridge Count Extraction Method - REM

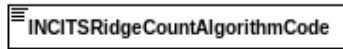

Field Reference: 9/RCI/REM
Content Type: Data
XML Tag Name: INCITSRidgeCountAlgorithmCode
Data Type: N
Minimum Length: 1
Minimum Occurrences: 1
Value range: *n/a*
Code table: see table [A.50](#)
Base type: biom:INCITSRidgeCountAlgorithmCodeType

Field ID: [09.138-A]
Condition: Mandatory within a field
Defined in: xsd/niem/biometrics/1.0/biometrics.xsd
Special Characters: *n/a*
Maximum Length: 1
Maximum Occurrences: 1
Regular Expression: *n/a*
Namespace: <http://niem.gov/niem/biometrics/1.0>

XPath

```
/itl:PackageMinutiaeRecord  
  ↙/biom:INCITSMinutiae  
    ↙/biom:MinutiaeRidgeCountDetail  
      ↙/biom:INCITSRidgeCountAlgorithmCode
```

Summary

Method of ridge count extraction.

Valid Examples

```
<biom:INCITSRidgeCountAlgorithmCode>1</biom:INCITSRidgeCountAlgorithmCode>
```

10.37. Minutiae Ridge Count Item (XML)

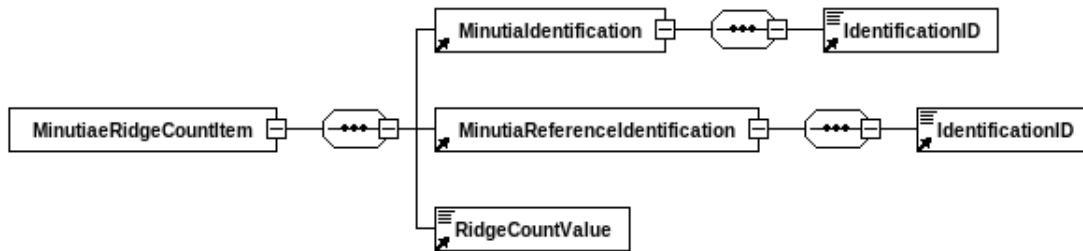

Field Reference: 9/RCI/CMI_9/RCI/NRC
Content Type: Set_X
XML Tag Name: MinutiaeRidgeCountItem
Data Type:
Minimum Length:
Minimum Occurrences: 1
Value range: *n/a*
Code table: *n/a*
Base type: biom:MinutiaeRidgeCountItemType

Field ID: [09.138-D_09.138-F]
Condition: Mandatory within a field
Defined in: xsd/niem/biometrics/1.0/biometrics.xsd
Special Characters: *n/a*
Maximum Length:
Maximum Occurrences: *
Regular Expression: *n/a*
Namespace: <http://niem.gov/niem/biometrics/1.0>

XPath

```

/it1:PackageMinutiaeRecord
  ↙/biom:INCITSMinutiae
    ↙/biom:MinutiaeRidgeCountDetail
      ↙/biom:MinutiaeRidgeCountItem
    
```

Summary

Minutiae ridge count.

Notes

Applies to 9.138-D, 9.138-E, and 9.138-F

10.38. Center Minutia Index Number - CMI

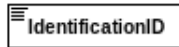

Field Reference: 9/RCI/CMI
Content Type: Data
XML Tag Name: IdentificationID
Data Type: N
Minimum Length: 1
Minimum Occurrences: 1
Value range: {>=1}
Code table: *n/a*
Base type: niem-xsd:string

Field ID: [09.138-D]
Condition: Mandatory within a field
Defined in: xsd/niem/niem-core/2.0/niem-core.xsd
Special Characters: *n/a*
Maximum Length: 4
Maximum Occurrences: 1
Regular Expression: *n/a*

Namespace: <http://niem.gov/niem/niem-core/2.0>

XPath

```

/itl:PackageMinutiaeRecord
  ↳/biom:INCITSMinutiae
    ↳/biom:MinutiaeRidgeCountDetail
      ↳/biom:MinutiaeRidgeCountItem
        ↳/biom:MinutiaIdentification
          ↳/nc:IdentificationID
  
```

Summary

Center minutia index.

Valid Examples

```
<nc:IdentificationID>22</nc:IdentificationID>
```

10.39. Neighboring Minutia Index Number - NMN

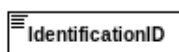

Field Reference: 9/RCI/NMN
Content Type: Data
XML Tag Name: IdentificationID
Data Type: N
Minimum Length: 1
Minimum Occurrences: 1
Value range: {>=1}
Code table: *n/a*
Base type: niem-xsd:string

Field ID: [09.138-E]
Condition: Mandatory within a field
Defined in: xsd/niem/niem-core/2.0/niem-core.xsd
Special Characters: *n/a*
Maximum Length: 4
Maximum Occurrences: 1
Regular Expression: *n/a*

Namespace: <http://niem.gov/niem/niem-core/2.0>

XPath

```

/itl:PackageMinutiaeRecord
  ↳/biom:INCITSMinutiae
    ↳/biom:MinutiaeRidgeCountDetail
      ↳/biom:MinutiaeRidgeCountItem
        ↳/biom:MinutiaReferenceIdentification
          ↳/nc:IdentificationID
  
```

Summary

Neighboring minutiae index number.

Valid Examples

```
<nc:IdentificationID>22</nc:IdentificationID>
```

10.40. Number of Ridges Crossed - NRC

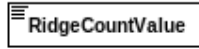

Field Reference: 9/RCI/NRC
Content Type: Data
XML Tag Name: RidgeCountValue
Data Type: N
Minimum Length: 1
Minimum Occurrences: 1
Value range: {1..99}
Code table: *n/a*
Base type: niem-xsd:nonNegativeInteger

Field ID: [09.138-F]
Condition: Mandatory within a field
Defined in: xsd/niem/biometrics/1.0/biometrics.xsd
Special Characters: *n/a*
Maximum Length: 2
Maximum Occurrences: 1
Regular Expression: *n/a*
Namespace: <http://niem.gov/niem/biometrics/1.0>

XPath

```
/itl:PackageMinutiaeRecord  
  ↳/biom:INCITSMinutiae  
    ↳/biom:MinutiaeRidgeCountDetail  
      ↳/biom:MinutiaeRidgeCountItem  
        ↳/biom:RidgeCountValue
```

Summary

Number of ridges crossed.

Valid Examples

```
<biom:RidgeCountValue>17</biom:RidgeCountValue>
```

10.41. M1 Core Information - CIN

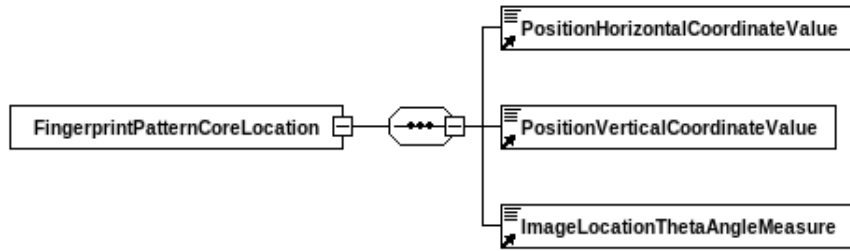

Field Reference: 9/CIN

Content Type: Set

XML Tag Name: FingerprintPatternCoreLocation

Data Type:

Minimum Length:

Minimum Occurrences: 0

Value range: *n/a*

Code table: *n/a*

Base type: biom:FingerprintFeatureLocationType

Field ID: [09.139]

Condition: Dependent (see table)

Defined in: xsd/niem/biometrics/1.0/biometrics.xsd

Special Characters: *n/a*

Maximum Length:

Maximum Occurrences: 9

Regular Expression: *n/a*

Namespace: <http://niem.gov/niem/biometrics/1.0>

Dependency table

Type of dependency	Value
Optional on Value of other Field, should not be set otherwise.	[9/CBI/CFT]IN{514,515}

XPath

```

/itl:PackageMinutiaeRecord
  ↳/biom:INCITSMinutiae
    ↳/biom:FingerprintPatternCoreLocation
  
```

Summary

Core information.

10.42. X Coordinate - XCC

 **PositionHorizontalCoordinateValue**

Field Reference: 9/CIN/XCC

Content Type: Data

XML Tag Name: PositionHorizontalCoordinateValue

Data Type: N

Minimum Length: 1

Minimum Occurrences: 1

Value range: {>=1}

Code table: *n/a*

Base type: niem-xsd:nonNegativeInteger

Field ID: [09.139-A]

Condition: Mandatory within a field

Defined in: xsd/niem/biometrics/1.0/biometrics.xsd

Special Characters: *n/a*

Maximum Length: 5

Maximum Occurrences: 1

Regular Expression: *n/a*

Namespace: <http://niem.gov/niem/biometrics/1.0>

XPath

```
/it1:PackageMinutiaeRecord
  ↳/biom:INCITSMinutiae
    ↳/biom:FingerprintPatternCoreLocation
      ↳/biom:PositionHorizontalCoordinateValue
```

Summary

X coordinate of core.

Valid Examples

```
<biom:PositionHorizontalCoordinateValue>2000</biom:PositionHorizontalCoordinateValue>
```

10.43. Y Coordinate - YCC

 PositionVerticalCoordinateValue
--

Field Reference: 9/CIN/YCC

Content Type: Data

XML Tag Name: PositionVerticalCoordinateValue

Data Type: N

Minimum Length: 1

Minimum Occurrences: 1

Value range: {>=1}

Code table: *n/a*

Base type: niem-xsd:nonNegativeInteger

Field ID: [09.139-B]

Condition: Mandatory within a field

Defined in: xsd/niem/biometrics/1.0/biometrics.xsd

Special Characters: *n/a*

Maximum Length: 5

Maximum Occurrences: 1

Regular Expression: *n/a*

Namespace: <http://niem.gov/niem/biometrics/1.0>

XPath

```
/it1:PackageMinutiaeRecord
  ↳/biom:INCITSMinutiae
    ↳/biom:FingerprintPatternCoreLocation
      ↳/biom:PositionVerticalCoordinateValue
```

Summary

Y coordinate of core.

Valid Examples

<code><biom:PositionVerticalCoordinateValue>2000</biom:PositionVerticalCoordinateValue></code>
--

10.44. Angle of the Core - ANGC

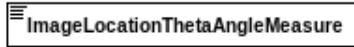

Field Reference: 9/CIN/ANGC
Content Type: Data
XML Tag Name: ImageLocationThetaAngleMeasure
Data Type: N
Minimum Length: 1
Minimum Occurrences: 1
Value range: {0..179}
Code table: *n/a*
Base type: biom:ThetaAngleMeasureType

Field ID: [09.139-C]
Condition: Mandatory within a field
Defined in: xsd/niem/biometrics/1.0/biometrics.xsd
Special Characters: *n/a*
Maximum Length: 3
Maximum Occurrences: 1
Regular Expression: *n/a*
Namespace: <http://niem.gov/niem/biometrics/1.0>

XPath

```
/itl:PackageMinutiaeRecord  
  ↙/biom:INCITSMinutiae  
    ↙/biom:FingerprintPatternCoreLocation  
      ↙/biom:ImageLocationThetaAngleMeasure
```

Summary

Core angle.

Valid Examples

```
<biom:ImageLocationThetaAngleMeasure>30</biom:ImageLocationThetaAngleMeasure>
```

10.45. M1 Delta Information - DIN

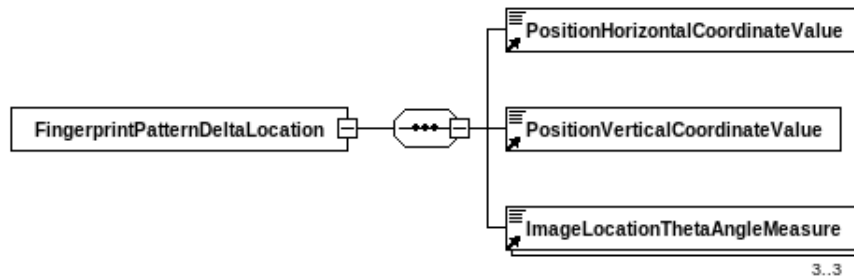

Field Reference: 9/DIN
Content Type: Set
XML Tag Name: FingerprintPatternDeltaLocation
Data Type:
Minimum Length:
Minimum Occurrences: 0
Value range: *n/a*
Code table: *n/a*
Base type: biom:FingerprintDeltaLocationType

Field ID: [09.140]
Condition: Dependent (see table)
Defined in: xsd/niem/biometrics/1.0/biometrics.xsd
Special Characters: *n/a*
Maximum Length:
Maximum Occurrences: 9
Regular Expression: *n/a*
Namespace: <http://niem.gov/niem/biometrics/1.0>

Dependency table

Type of dependency	Value
Optional on Value of other Field, should not be set otherwise.	[9/CBI/CFT]IN{514,515}

XPath

```

/it1:PackageMinutiaeRecord
  ↳/biom:INCITSMinutiae
    ↳/biom:FingerprintPatternDeltaLocation
    
```

Summary

Delta information.

10.46. X Coordinate - XCD

 PositionHorizontalCoordinateValue

Field Reference: 9/DIN/XCD

Content Type: Data

XML Tag Name: PositionHorizontalCoordinateValue

Data Type: N

Minimum Length: 1

Minimum Occurrences: 1

Value range: {>=1}

Code table: *n/a*

Base type: niem-xsd:nonNegativeInteger

Field ID: [09.140-A]

Condition: Mandatory within a field

Defined in: xsd/niem/biometrics/1.0/biometrics.xsd

Special Characters: *n/a*

Maximum Length: 5

Maximum Occurrences: 1

Regular Expression: *n/a*

Namespace: <http://niem.gov/niem/biometrics/1.0>

XPath

```
/it1:PackageMinutiaeRecord
  ↳/biom:INCITSMinutiae
    ↳/biom:FingerprintPatternDeltaLocation
      ↳/biom:PositionHorizontalCoordinateValue
```

Summary

X coordinate of delta.

Valid Examples

<code><biom:PositionHorizontalCoordinateValue>3154</biom:PositionHorizontalCoordinateValue></code>
--

10.47. Y Coordinate - YCD

 **PositionVerticalCoordinateValue**

Field Reference: 9/DIN/YCD

Content Type: Data

XML Tag Name: PositionVerticalCoordinateValue

Data Type: N

Minimum Length: 1

Minimum Occurrences: 1

Value range: {>=1}

Code table: *n/a*

Base type: niem-xsd:nonNegativeInteger

Field ID: [09.140-B]

Condition: Mandatory within a field

Defined in: xsd/niem/biometrics/1.0/biometrics.xsd

Special Characters: *n/a*

Maximum Length: 5

Maximum Occurrences: 1

Regular Expression: *n/a*

Namespace: <http://niem.gov/niem/biometrics/1.0>

XPath

```
/it1:PackageMinutiaeRecord
  ↳/biom:INCITSMinutiae
    ↳/biom:FingerprintPatternDeltaLocation
      ↳/biom:PositionVerticalCoordinateValue
```

Summary

Y coordinate of delta.

Valid Examples

```
<biom:PositionVerticalCoordinateValue>3154</biom:PositionVerticalCoordinateValue>
```

10.48. First, Second, and Third Angles of the Delta

 ImageLocationThetaAngleMeasure
--

Field Reference: 9/DIN/ANG1_9/ADA/ANG3
Content Type: Data_1X-NT
XML Tag Name: ImageLocationThetaAngleMeasure
Data Type: N
Minimum Length: 1
Minimum Occurrences: 1
Value range: {0..179}
Code table: *n/a*
Base type: biom:ThetaAngleMeasureType

Field ID: [09.140-C_09.141-B]
Condition: Mandatory within a field
Defined in: xsd/niem/biometrics/1.0/biometrics.xsd
Special Characters: *n/a*
Maximum Length: 3
Maximum Occurrences: 3
Regular Expression: *n/a*

Namespace: <http://niem.gov/niem/biometrics/1.0>

XPath

```

/itl:PackageMinutiaeRecord
  ↙/biom:INCITSMinutiae
    ↙/biom:FingerprintPatternDeltaLocation
      ↙/biom:ImageLocationThetaAngleMeasure
  
```

Summary

First, second, and third delta angles.

Notes

Applies to 9.140-C, 9.141-A and 9.141-B

Valid Examples

```
<biom:ImageLocationThetaAngleMeasure>33</biom:ImageLocationThetaAngleMeasure>
```

10.49. Extended Feature Set Minutiae (XML)

Field Reference: 9/ROI_9/RPS	Field ID: [09.300_09.373]
Content Type: Set_X	Condition: Optional
XML Tag Name: ExtendedFeatureSetMinutiae	Defined in: xsd/niem/biometrics/1.0/biometrics.xsd
Data Type:	Special Characters: <i>n/a</i>
Minimum Length:	Maximum Length:
Minimum Occurrences: 0	Maximum Occurrences: *
Value range: <i>n/a</i>	Regular Expression: <i>n/a</i>
Code table: <i>n/a</i>	
Base type: biom:ExtendedFeatureSetMinutiaeType	Namespace: http://niem.gov/niem/biometrics/1.0

XPath

```
/it1:PackageMinutiaeRecord  
  ↘/biom:ExtendedFeatureSetMinutiae
```

Summary

Type-9 fields for the Extended Feature Set (EFS). The EFS specification defines a quantifiable, repeatable, and clear method of characterizing the information content of a fingerprint or other friction ridge image.

Notes

Applies to 9.300, 9.301, 9.302, 9.303, 9.307, 9.308, 9.309, 9.310, 9.311, 9.312, 9.313, 9.314, 9.315, 9.316, 9.317, 9.320, 9.321, 9.322, 9.323, 9.324, 9.325, 9.326, 9.327, 9.331, 9.332, 9.333, 9.334, 9.335, 9.340, 9.341, 9.342, 9.343, 9.344, 9.345, 9.346, 9.347, 9.348, 9.349, 9.350, 9.351, 9.352, 9.353, 9.354, 9.355, 9.356, 9.357, 9.360, 9.361, 9.362, 9.363, 9.372 and 9.373

10. Minutiae Data Record (aka Type 9)



10.50. EFS Region of Interest - ROI

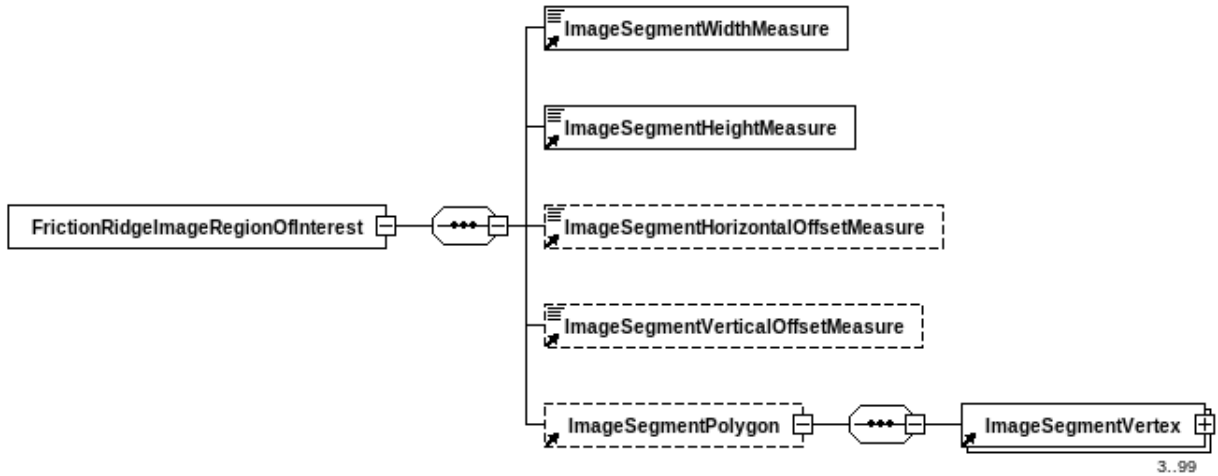

Field Reference: 9/ROI
Content Type: Set
XML Tag Name: FrictionRidgeImageRegionOfInterest
Data Type:
Minimum Length:
Minimum Occurrences: 0
Value range: *n/a*
Code table: *n/a*
Base type: biom:FrictionRidgeImageRegionOfInterestType

Field ID: [09.300]
Condition: Dependent (see table)
Defined in: xsd/niem/biometrics/1.0/biometrics.xsd
Special Characters: *n/a*
Maximum Length:
Maximum Occurrences: 1
Regular Expression: *n/a*
Namespace: <http://niem.gov/niem/biometrics/1.0>

Dependency table

Type of dependency	Value
Mandatory on Presence of other Field	9/FPP

XPath

```

/it1:PackageMinutiaeRecord
  ↳/biom:ExtendedFeatureSetMinutiae
    ↳/biom:FrictionRidgeImageRegionOfInterest
    
```

Summary

Rectangle or a polygon that bounds the area of the original image containing a single friction ridge impression, and separates it from the background and any other friction ridge data present in the image.

Notes

All EFS features are in relation to the Region of Interest, not to the original image; all coordinates are relative to the top left corner of the ROI.

10.51. ROI Width - EWI

ImageSegmentWidthMeasure

Field Reference: 9/ROI/EWI

Content Type: Data

XML Tag Name: ImageSegmentWidthMeasure

Data Type: N

Minimum Length: 1

Minimum Occurrences: 1

Value range: {1..50000}

Code table: *n/a*

Base type: niem-xsd:nonNegativeInteger

Field ID: [09.300-A]

Condition: Mandatory within a field

Defined in: xsd/niem/biometrics/1.0/biometrics.xsd

Special Characters: *n/a*

Maximum Length: 5

Maximum Occurrences: 1

Regular Expression: *n/a*

Namespace: <http://niem.gov/niem/biometrics/1.0>

XPath

```
/it1:PackageMinutiaeRecord
  ↳/biom:ExtendedFeatureSetMinutiae
    ↳/biom:FrictionRidgeImageRegionOfInterest
      ↳/biom:ImageSegmentWidthMeasure
```

Summary

Width of region of interest in units of 10 micrometers (0.01 mm).

Valid Examples

```
<biom:ImageSegmentWidthMeasure>50000</biom:ImageSegmentWidthMeasure>
```

10.52. ROI Height - EHI

ImageSegmentHeightMeasure

Field Reference: 9/ROI/EHI

Content Type: Data

XML Tag Name: ImageSegmentHeightMeasure

Data Type: N

Minimum Length: 1

Minimum Occurrences: 1

Value range: {1..50000}

Code table: *n/a*

Base type: niem-xsd:nonNegativeInteger

Field ID: [09.300-B]

Condition: Mandatory within a field

Defined in: xsd/niem/biometrics/1.0/biometrics.xsd

Special Characters: *n/a*

Maximum Length: 5

Maximum Occurrences: 1

Regular Expression: *n/a*

Namespace: <http://niem.gov/niem/biometrics/1.0>

XPath

```
/it1:PackageMinutiaeRecord
  ↳/biom:ExtendedFeatureSetMinutiae
    ↳/biom:FrictionRidgeImageRegionOfInterest
      ↳/biom:ImageSegmentHeightMeasure
```

Summary

Height of region of interest in units of 10 micrometers (0.01 mm).

Valid Examples

```
<biom:ImageSegmentHeightMeasure>50000</biom:ImageSegmentHeightMeasure>
```

10.53. ROI Horizontal Offset - EHO

ImageSegmentHorizontalOffsetMeasure

Field Reference: 9/ROI/EHO

Content Type: Data

XML Tag Name: ImageSegmentHorizontalOffsetMeasure

Data Type: N

Minimum Length: 1

Minimum Occurrences: 0

Value range: {1..50000}

Code table: *n/a*

Base type: niem-xsd:nonNegativeInteger

Field ID: [09.300-C]

Condition: Optional within a field

Defined in: xsd/niem/biometrics/1.0/biometrics.xsd

Special Characters: *n/a*

Maximum Length: 5

Maximum Occurrences: 1

Regular Expression: *n/a*

Namespace: <http://niem.gov/niem/biometrics/1.0>

Exceptions

see Technical Notes below

XPath

```
/it1:PackageMinutiaeRecord
  ↳/biom:ExtendedFeatureSetMinutiae
    ↳/biom:FrictionRidgeImageRegionOfInterest
      ↳/biom:ImageSegmentHorizontalOffsetMeasure
```

Summary

Horizontal distance in units of 10 micrometers from left edge of image to left edge of region of interest.

Technical Notes

If absent, defaults to zero.

Valid Examples

```
<biom:ImageSegmentHorizontalOffsetMeasure>35478</biom:ImageSegmentHorizontalOffsetMeasure>
```

10.54. ROI Vertical Offset - EVO

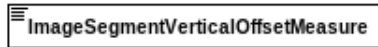

Field Reference: 9/ROI/EVO

Content Type: Data

XML Tag Name: ImageSegmentVerticalOffsetMeasure

Data Type: N

Minimum Length: 1

Minimum Occurrences: 0

Value range: {1..50000}

Code table: *n/a*

Base type: niem-xsd:nonNegativeInteger

Field ID: [09.300-D]

Condition: Optional within a field

Defined in: xsd/niem/biometrics/1.0/biometrics.xsd

Special Characters: *n/a*

Maximum Length: 5

Maximum Occurrences: 1

Regular Expression: *n/a*

Namespace: <http://niem.gov/niem/biometrics/1.0>

Exceptions

see Technical Notes below

XPath

```
/it1:PackageMinutiaeRecord
  ↳/biom:ExtendedFeatureSetMinutiae
    ↳/biom:FrictionRidgeImageRegionOfInterest
      ↳/biom:ImageSegmentVerticalOffsetMeasure
```

Summary

Vertical distance in units of 10 micrometers from top edge of image to top edge of region of interest.

Technical Notes

If absent, defaults to zero.

Valid Examples

```
<biom:ImageSegmentVerticalOffsetMeasure>35478</biom:ImageSegmentVerticalOffsetMeasure>
```

10.55. ROI Polygon (XML) - ROP

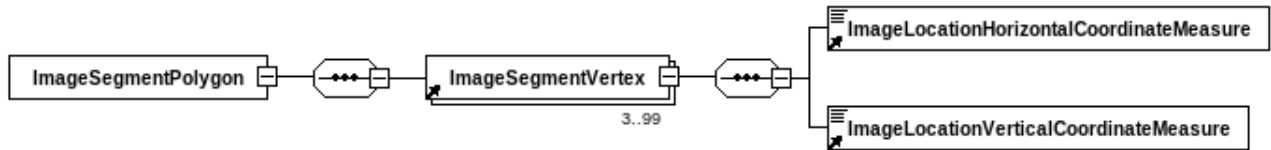

Field Reference: 9/ROI/ROP:X1
Content Type: Set_X
XML Tag Name: ImageSegmentPolygon
Data Type:
Minimum Length:
Minimum Occurrences: 0
Value range: *n/a*
Code table: *n/a*
Base type: biom:ImageSegmentPolygonType

Field ID: [09.300-E:X1]
Condition: Optional within a field
Defined in: xsd/niem/biometrics/1.0/biometrics.xsd
Special Characters: *n/a*
Maximum Length:
Maximum Occurrences: 1
Regular Expression: *n/a*
Namespace: <http://niem.gov/niem/biometrics/1.0>

XPath

```

/itl:PackageMinutiaeRecord
  ↙/biom:ExtendedFeatureSetMinutiae
    ↙/biom:FrictionRidgeImageRegionOfInterest
      ↙/biom:ImageSegmentPolygon
    
```

Summary

Polygon that further defines the friction ridge area.

10.56. Image Segment Vertex (XML) - ROP

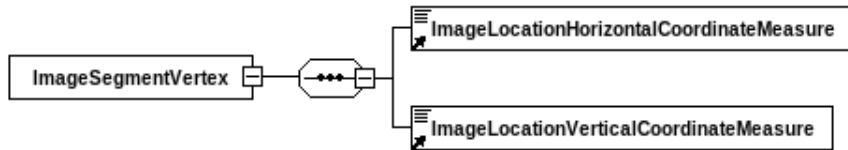

Field Reference: 9/ROI/ROP:X2
Content Type: Set_X
XML Tag Name: ImageSegmentVertex
Data Type:
Minimum Length:
Minimum Occurrences: 3
Value range: *n/a*
Code table: *n/a*
Base type: biom:ImageSegmentVertexType

Field ID: [09.300-E:X2]
Condition: Mandatory within a field
Defined in: xsd/niem/biometrics/1.0/biometrics.xsd
Special Characters: *n/a*
Maximum Length:
Maximum Occurrences: 99
Regular Expression: *n/a*
Namespace: <http://niem.gov/niem/biometrics/1.0>

XPath

```

/itl:PackageMinutiaeRecord
├─/biom:ExtendedFeatureSetMinutiae
│   └─/biom:FrictionRidgeImageRegionOfInterest
│       └─/biom:ImageSegmentPolygon
│           └─/biom:ImageSegmentVertex
    
```

Summary

Polygon that further defines the friction ridge area.

10.57. Image Location Horizontal Coordinate Measure (XML) - ROP

ImageLocationHorizontalCoordinateMeasure

Field Reference: 9/ROI/ROP:X3

Content Type: Data_NX-1T

XML Tag Name: ImageLocationHorizontalCoordinateMeasure

Data Type: N

Minimum Length: 1

Minimum Occurrences: 1

Value range: {0..49999}

Code table: *n/a*

Base type: niem-xsd:integer

Field ID: [09.300-E:X3]

Condition: Mandatory within a field

Defined in: xsd/niem/biometrics/1.0/biometrics.xsd

Special Characters: *n/a*

Maximum Length: 5

Maximum Occurrences: 1

Regular Expression: *n/a*

Namespace: <http://niem.gov/niem/biometrics/1.0>

XPath

```

/itl:PackageMinutiaeRecord
  ↳/biom:ExtendedFeatureSetMinutiae
    ↳/biom:FrictionRidgeImageRegionOfInterest
      ↳/biom:ImageSegmentPolygon
        ↳/biom:ImageSegmentVertex
          ↳/biom:ImageLocationHorizontalCoordinateMeasure
  
```

Summary

Polygon that further defines the friction ridge area.

Valid Examples

<code><biom:ImageLocationHorizontalCoordinateMeasure>130</biom:ImageLocationHorizontalCoordinateMeasure></code>

10.58. Image Location Vertical Coordinate Measure (XML) - ROP

 ImageLocationVerticalCoordinateMeasure

Field Reference: 9/ROI/ROP:X4

Content Type: Data_NX-1T

XML Tag Name: ImageLocationVerticalCoordinateMeasure

Data Type: N

Minimum Length: 1

Minimum Occurrences: 1

Value range: {0..49999}

Code table: *n/a*

Base type: niem-xsd:integer

Field ID: [09.300-E:X4]

Condition: Mandatory within a field

Defined in: xsd/niem/biometrics/1.0/biometrics.xsd

Special Characters: *n/a*

Maximum Length: 5

Maximum Occurrences: 1

Regular Expression: *n/a*

Namespace: <http://niem.gov/niem/biometrics/1.0>

XPath

```

/itl:PackageMinutiaeRecord
  ↳/biom:ExtendedFeatureSetMinutiae
    ↳/biom:FrictionRidgeImageRegionOfInterest
      ↳/biom:ImageSegmentPolygon
        ↳/biom:ImageSegmentVertex
          ↳/biom:ImageLocationVerticalCoordinateMeasure
  
```

Summary

Polygon that further defines the friction ridge area.

Valid Examples

<pre><biom:ImageLocationVerticalCoordinateMeasure>275</biom:ImageLocationVerticalCoordinateMeasure></pre>

10.59. EFS Orientation - ORT

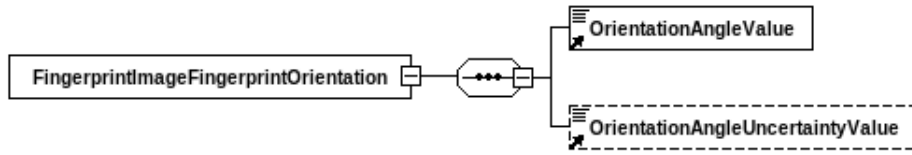

Field Reference: 9/ORT

Content Type: Set

XML Tag Name: FingerprintImageFingerprintOrientation

Data Type:

Minimum Length:

Minimum Occurrences: 0

Value range: *n/a*

Code table: *n/a*

Base type: biom:FingerprintImageFingerprintOrientationType

Field ID: [09.301]

Condition: Dependent (see table)

Defined in: xsd/niem/biometrics/1.0/biometrics.xsd

Special Characters: *n/a*

Maximum Length:

Maximum Occurrences: 1

Regular Expression: *n/a*

Namespace: <http://niem.gov/niem/biometrics/1.0>

Dependency table

Type of dependency	Value
Optional on Presence of other Field	9/ROI

XPath

```
/it1:PackageMinutiaeRecord
  ↳/biom:ExtendedFeatureSetMinutiae
    ↳/biom:FingerprintImageFingerprintOrientation
```

Summary

Orientation and direction uncertainty of EFS region of interest.

10.60. Direction - EOD

OrientationAngleValue

Field Reference: 9/ORT/EOD

Content Type: Data

XML Tag Name: OrientationAngleValue

Data Type: NS

Minimum Length: 1

Minimum Occurrences: 1

Value range: {-179..180}

Code table: *n/a*

Base type: biom:RelativeRotationMeasureType

Field ID: [09.301-A]

Condition: Mandatory within a field

Defined in: xsd/niem/biometrics/1.0/biometrics.xsd

Special Characters: [-]

Maximum Length: 4

Maximum Occurrences: 1

Regular Expression: *n/a*

Namespace: <http://niem.gov/niem/biometrics/1.0>

Exceptions

see Technical Notes below

XPath

```
/itl:PackageMinutiaeRecord
  ↳/biom:ExtendedFeatureSetMinutiae
    ↳/biom:FingerprintImageFingerprintOrientation
      ↳/biom:OrientationAngleValue
```

Summary

Deviation of region of interest from upright (fingertip up) in integer degrees.

Notes

Positive angles are counterclockwise, negative angles are clockwise. A value of "0" indicates an upright direction.

Technical Notes

If field is omitted, the direction shall default to 0 (upright).

Valid Examples

```
<biom:OrientationAngleValue>2</biom:OrientationAngleValue>
```

10.61. Uncertainty - EUC

☰ OrientationAngleUncertaintyValue

Field Reference: 9/ORT/EUC

Content Type: Data

XML Tag Name: OrientationAngleUncertaintyValue

Data Type: N

Minimum Length: 1

Minimum Occurrences: 0

Value range: {0..180}

Code table: *n/a*

Base type: biom:UncertaintyValueType

Field ID: [09.301-B]

Condition: Optional within a field

Defined in: xsd/niem/biometrics/1.0/biometrics.xsd

Special Characters: *n/a*

Maximum Length: 3

Maximum Occurrences: 1

Regular Expression: *n/a*

Namespace: <http://niem.gov/niem/biometrics/1.0>

Exceptions

see Technical Notes below

XPath

```
/itl:PackageMinutiaeRecord
├─/biom:ExtendedFeatureSetMinutiae
│   └─/biom:FingerprintImageFingerprintOrientation
│       └─/biom:OrientationAngleUncertaintyValue
```

Summary

Uncertainty of orientation direction in integer degrees. If orientation cannot be determined, the uncertainty value shall be set to 180.

Technical Notes

If field is omitted, the direction shall default to 0 (upright).

Valid Examples

<biom:OrientationAngleUncertaintyValue>180</biom:OrientationAngleUncertaintyValue>
--

10.62. EFS Finger, Palm, Plantar Position - FPP

Field Reference: 9/FPP	Field ID: [09.302]
Content Type: Set	Condition: Dependent (see table)
XML Tag Name: MinutiaePalmLocation or MinutiaePlantarLocation or MinutiaeFingerLocation	Defined in: xsd/niem/biometrics/1.0/biometrics.xsd
Data Type:	Special Characters: <i>n/a</i>
Minimum Length:	Maximum Length:
Minimum Occurrences: 0	Maximum Occurrences: 20
Value range: <i>n/a</i>	Regular Expression: <i>n/a</i>
Code table: <i>n/a</i>	
Base type: biom:MinutiaePlantarLocationType or biom:MinutiaeFingerLocationType or biom:MinutiaePalmLocationType	Namespace: http://niem.gov/niem/biometrics/1.0

Dependency table

Type of dependency	Value
Mandatory on Presence of other Field	9/ROI

XPath

```

if [9/FPP/FGP] IN 0..19, 40..50 then
/itl:PackageMinutiaeRecord
  ↙/biom:ExtendedFeatureSetMinutiae
    ↙/biom:MinutiaeFingerLocation
elseif [9/FPP/FGP] IN 20..38, 81..82 then
/itl:PackageMinutiaeRecord
  ↙/biom:ExtendedFeatureSetMinutiae
    ↙/biom:MinutiaePalmLocation
else
/itl:PackageMinutiaeRecord
  ↙/biom:ExtendedFeatureSetMinutiae
    ↙/biom:MinutiaePlantarLocation
endif
    
```

Summary

Physical position(s) that correspond to the EFS region of interest.

10.63. Friction Ridge Generalized Position - FGP

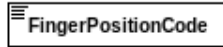

Field Reference: 9/FPP/FGP

Content Type: Data

XML Tag Name: FingerPositionCode or PalmPositionCode or PlantarPositionCode

Data Type: N

Minimum Length: 1

Minimum Occurrences: 1

Value range: *n/a*

Code table: see table A.25 and table A.26

Base type: biom:PalmPositionCodeType or biom:PlantarPositionCodeType or biom:FingerPositionCodeType

Field ID: [09.302-A]

Condition: Mandatory within a field

Defined in: xsd/niem/biometrics/1.0/biometrics.xsd

Special Characters: *n/a*

Maximum Length: 2

Maximum Occurrences: 1

Regular Expression: *n/a*

Namespace: <http://niem.gov/niem/biometrics/1.0>

XPath

```
if [9/FPP/FGP] IN 0..19, 40..50 then
/itl:PackageMinutiaeRecord
  ↙/biom:ExtendedFeatureSetMinutiae
    ↙/biom:MinutiaeFingerLocation
      ↙/biom:FingerPositionCode
elseif [9/FPP/FGP] IN 20..38, 81..82 then
/itl:PackageMinutiaeRecord
  ↙/biom:ExtendedFeatureSetMinutiae
    ↙/biom:MinutiaePalmLocation
      ↙/biom:PalmPositionCode
else
/itl:PackageMinutiaeRecord
  ↙/biom:ExtendedFeatureSetMinutiae
    ↙/biom:MinutiaePlantarLocation
      ↙/biom:PlantarPositionCode
endif
```

Summary

Finger position code.

Valid Examples

```
<biom:FingerPositionCode>17</biom:FingerPositionCode>
```

10.64. Segment Polygon (XML) - SGP

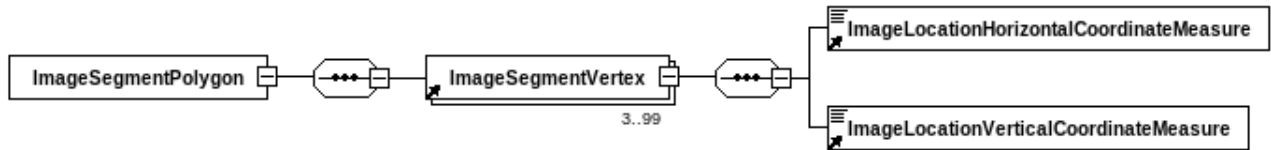

Field Reference: 9/FPP/SGP:X1
Content Type: Set_X
XML Tag Name: ImageSegmentPolygon
Data Type:
Minimum Length:
Minimum Occurrences: 0
Value range: *n/a*
Code table: *n/a*
Base type: biom:ImageSegmentPolygonType

Field ID: [09.302-D:X1]
Condition: Optional within a field
Defined in: xsd/niem/biometrics/1.0/biometrics.xsd
Special Characters: *n/a*
Maximum Length:
Maximum Occurrences: 1
Regular Expression: *n/a*
Namespace: <http://niem.gov/niem/biometrics/1.0>

XPath

```

if [9/FPP/FGP] IN 0..19, 40..50 then
/itl:PackageMinutiaeRecord
  ↙/biom:ExtendedFeatureSetMinutiae
    ↙/biom:MinutiaeFingerLocation
      ↙/biom:ImageSegmentPolygon
elseif [9/FPP/FGP] IN 20..38, 81..82 then
/itl:PackageMinutiaeRecord
  ↙/biom:ExtendedFeatureSetMinutiae
    ↙/biom:MinutiaePalmLocation
      ↙/biom:ImageSegmentPolygon
else
/itl:PackageMinutiaeRecord
  ↙/biom:ExtendedFeatureSetMinutiae
    ↙/biom:MinutiaePlantarLocation
      ↙/biom:ImageSegmentPolygon
endif
  
```

Summary

Closed path polygon that delineates the area that corresponds to the specified position/segment.

10.65. Image Segment Vertex (XML) - SGP

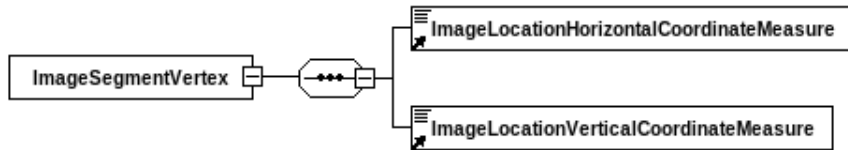

Field Reference: 9/FPP/SGP:X2
Content Type: Set_X
XML Tag Name: ImageSegmentVertex
Data Type:
Minimum Length:
Minimum Occurrences: 3
Value range: *n/a*
Code table: *n/a*
Base type: biom:ImageSegmentVertexType

Field ID: [09.302-D:X2]
Condition: Mandatory within a field
Defined in: xsd/niem/biometrics/1.0/biometrics.xsd
Special Characters: *n/a*
Maximum Length:
Maximum Occurrences: 99
Regular Expression: *n/a*
Namespace: <http://niem.gov/niem/biometrics/1.0>

XPath

```

if [9/FPP/FGP] IN 0..19, 40..50 then
/itl:PackageMinutiaeRecord
  ↙/biom:ExtendedFeatureSetMinutiae
    ↙/biom:MinutiaeFingerLocation
      ↙/biom:ImageSegmentPolygon
        ↙/biom:ImageSegmentVertex
elseif [9/FPP/FGP] IN 20..38, 81..82 then
/itl:PackageMinutiaeRecord
  ↙/biom:ExtendedFeatureSetMinutiae
    ↙/biom:MinutiaePalmLocation
      ↙/biom:ImageSegmentPolygon
        ↙/biom:ImageSegmentVertex
else
/itl:PackageMinutiaeRecord
  ↙/biom:ExtendedFeatureSetMinutiae
    ↙/biom:MinutiaePlantarLocation
      ↙/biom:ImageSegmentPolygon
        ↙/biom:ImageSegmentVertex
endif
  
```

Summary

Closed path polygon that delineates the area that corresponds to the specified position/segment.

10.66. Image Location Horizontal Coordinate Measure (XML) - SGP

ImageLocationHorizontalCoordinateMeasure
--

Field Reference: 9/FPP/SGP:X3

Content Type: Data_NX-1T

XML Tag Name: ImageLocationHorizontalCoordinateMeasure

Data Type: N

Minimum Length: 1

Minimum Occurrences: 1

Value range: {0..49999}

Code table: *n/a*

Base type: niem-xsd:integer

Field ID: [09.302-D:X3]

Condition: Mandatory within a field

Defined in: xsd/niem/biometrics/1.0/biometrics.xsd

Special Characters: *n/a*

Maximum Length: 5

Maximum Occurrences: 1

Regular Expression: *n/a*

Namespace: <http://niem.gov/niem/biometrics/1.0>

XPath

```

if [9/FPP/FGP] IN 0..19, 40..50 then
/itl:PackageMinutiaeRecord
  ↪/biom:ExtendedFeatureSetMinutiae
    ↪/biom:MinutiaeFingerLocation
      ↪/biom:ImageSegmentPolygon
        ↪/biom:ImageSegmentVertex
          ↪/biom:ImageLocationHorizontalCoordinateMeasure
elseif [9/FPP/FGP] IN 20..38, 81..82 then
/itl:PackageMinutiaeRecord
  ↪/biom:ExtendedFeatureSetMinutiae
    ↪/biom:MinutiaePalmLocation
      ↪/biom:ImageSegmentPolygon
        ↪/biom:ImageSegmentVertex
          ↪/biom:ImageLocationHorizontalCoordinateMeasure
else
/itl:PackageMinutiaeRecord
  ↪/biom:ExtendedFeatureSetMinutiae
    ↪/biom:MinutiaePlantarLocation
      ↪/biom:ImageSegmentPolygon
        ↪/biom:ImageSegmentVertex
          ↪/biom:ImageLocationHorizontalCoordinateMeasure
endif

```

Summary

Closed path polygon that delineates the area that corresponds to the specified position/segment.

Valid Examples

<biom:ImageLocationHorizontalCoordinateMeasure>2130</biom:ImageLocationHorizontalCoordinateMeasure>

10.67. Image Location Vertical Coordinate Measure (XML) - SGP

ImageLocationVerticalCoordinateMeasure

Field Reference: 9/FPP/SGP:X4

Content Type: Data_NX-1T

XML Tag Name: ImageLocationVerticalCoordinateMeasure

Data Type: N

Minimum Length: 1

Minimum Occurrences: 1

Value range: {0..49999}

Code table: *n/a*

Base type: niem-xsd:integer

Field ID: [09.302-D:X4]

Condition: Mandatory within a field

Defined in: xsd/niem/biometrics/1.0/biometrics.xsd

Special Characters: *n/a*

Maximum Length: 5

Maximum Occurrences: 1

Regular Expression: *n/a*

Namespace: <http://niem.gov/niem/biometrics/1.0>

XPath

```

if [9/FPP/FGP] IN 0..19, 40..50 then
/itl:PackageMinutiaeRecord
  ↙/biom:ExtendedFeatureSetMinutiae
    ↙/biom:MinutiaeFingerLocation
      ↙/biom:ImageSegmentPolygon
        ↙/biom:ImageSegmentVertex
          ↙/biom:ImageLocationVerticalCoordinateMeasure
elseif [9/FPP/FGP] IN 20..38, 81..82 then
/itl:PackageMinutiaeRecord
  ↙/biom:ExtendedFeatureSetMinutiae
    ↙/biom:MinutiaePalmLocation
      ↙/biom:ImageSegmentPolygon
        ↙/biom:ImageSegmentVertex
          ↙/biom:ImageLocationVerticalCoordinateMeasure
else
/itl:PackageMinutiaeRecord
  ↙/biom:ExtendedFeatureSetMinutiae
    ↙/biom:MinutiaePlantarLocation
      ↙/biom:ImageSegmentPolygon
        ↙/biom:ImageSegmentVertex
          ↙/biom:ImageLocationVerticalCoordinateMeasure
endif

```

Summary

Closed path polygon that delineates the area that corresponds to the specified position/segment

Valid Examples

```
<biom:ImageLocationVerticalCoordinateMeasure>6</biom:ImageLocationVerticalCoordinateMeasure>
```

10.68. EFS Feature Set Profile - FSP



Field Reference: 9/FSP
Content Type: Data
XML Tag Name: IdentificationID
Data Type: N
Minimum Length: 1
Minimum Occurrences: 0
Value range: *n/a*
Code table: see table A.20
Base type: niem-xsd:string

Field ID: [09.303]
Condition: Dependent (see table)
Defined in: xsd/niem/niem-core/2.0/niem-core.xsd
Special Characters: *n/a*
Maximum Length: 2
Maximum Occurrences: 9
Regular Expression: *n/a*

Namespace: <http://niem.gov/niem/niem-core/2.0>

Exceptions
 see Technical Notes below

Dependency table

Type of dependency	Value
Optional on Presence of other Field	9/ROI

XPath

```
/itl:PackageMinutiaeRecord
  ↳/biom:ExtendedFeatureSetMinutiae
    ↳/biom:ExtendedFeatureSetProfileIdentification
      ↳/nc:IdentificationID
```

Summary

EFS Profile, which defines the specific set of EFS fields incorporated in a specific ANSI/NIST-ITL transaction.

Notes

CodeTable obtained NIST Special Publication 1134: Extended Feature Set Profile Specification (<http://nvlpubs.nist.gov/nistpubs/SpecialPublications/NIST.SP.1134.pdf>)
 9/EFS=10 requires 9/SIM. 9/EFS=11 requires 9/MRA and 9/MRC.

Technical Notes

Note this can have multiple occurrences, so the requirements apply if ANY of the 9/FSP occurrences is defined. If 9/FSP=1, then (either 9/COR or 9/NCOR is required) and (either 9/DEL or 9/NDEL is required). 9/FSP=2 has requirements of 9/FSP=1 as well as (either 9/MIN or 9/NMIN is required). 9/FSP=3 has the requirements of 9/FSP=1 and 2 as well as required 9/RQM, 9/RFM, and (either 9/DOT or 9/NDOT) and (either 9/INR or 9/NINR).

Valid Examples

```
<nc:IdentificationID>11</nc:IdentificationID>
```

10.69. EFS Pattern Classification - PAT

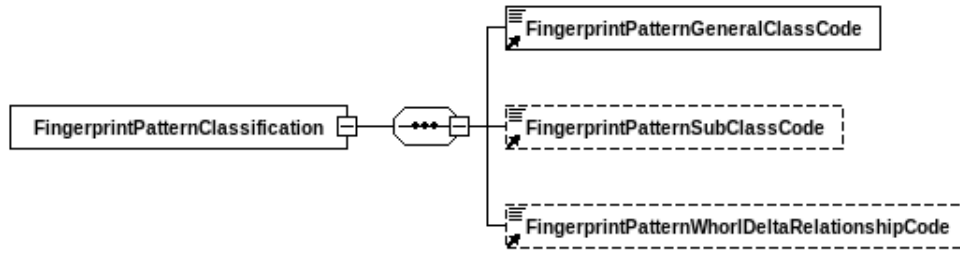

Field Reference: 9/PAT
Content Type: Set
XML Tag Name: FingerprintPatternClassification
Data Type:
Minimum Length:
Minimum Occurrences: 0
Value range: *n/a*
Code table: *n/a*
Base type: biom:FingerprintPatternClassificationType

Field ID: [09.307]
Condition: Dependent (see table)
Defined in: xsd/niem/biometrics/1.0/biometrics.xsd
Special Characters: *n/a*
Maximum Length:
Maximum Occurrences: 7
Regular Expression: *n/a*
Namespace: <http://niem.gov/niem/biometrics/1.0>

Dependency table

Type of dependency	Value
Optional on Presence of other Field	9/ROI

XPath

```

/it1:PackageMinutiaeRecord
  ↳/biom:ExtendedFeatureSetMinutiae
    ↳/biom:FingerprintPatternClassification
    
```

Summary

EFS fingerprint classification information for image.

Notes

This field shall only be used for fingerprints, and shall be omitted for other friction ridge impressions. Complete Scar (SR) and Dissociated Ridges/Dysplasia (DR) should only be noted if the fingerprint cannot be classified. If the print can be classified and scar(s), dissociated ridges, and/or dysplasia are present, this field should note the classification(s) and the scar(s), dissociated ridges, and/or dysplasia should be noted in Field 9.324: EFS distinctive features / DIS. The use of Field 9.322: EFS core delta ridge counts / CDR can be used to further subcategorize pattern classification.

10.70. General Class - GCF

 FingerprintPatternGeneralClassCode

Field Reference: 9/PAT/GCF

Content Type: Data

XML Tag Name: FingerprintPatternGeneralClassCode

Data Type: A

Minimum Length: 2

Minimum Occurrences: 1

Value range: *n/a*

Code table: see table [A.42](#)

Base type: biom:FingerprintPatternGeneralClassCodeType

Field ID: [09.307-A]

Condition: Mandatory within a field

Defined in: xsd/niem/biometrics/1.0/biometrics.xsd

Special Characters: *n/a*

Maximum Length: 2

Maximum Occurrences: 1

Regular Expression: *n/a*

Namespace: <http://niem.gov/niem/biometrics/1.0>

XPath

```
/it1:PackageMinutiaeRecord
  ↳/biom:ExtendedFeatureSetMinutiae
    ↳/biom:FingerprintPatternClassification
      ↳/biom:FingerprintPatternGeneralClassCode
```

Summary

General pattern classification (arch, whorl, left, or right loop).

Valid Examples

<pre><biom:FingerprintPatternGeneralClassCode>SR</biom:FingerprintPatternGeneralClassCode></pre>
--

10.71. Subclass - SUB

 FingerprintPatternSubClassCode

Field Reference: 9/PAT/SUB

Content Type: Data

XML Tag Name: FingerprintPatternSubClassCode

Data Type: A

Minimum Length: 2

Minimum Occurrences: 0

Value range: *n/a*

Code table: see table [A.43](#)

Base type: biom:FingerprintPatternSubClassCodeType

Field ID: [09.307-B]

Condition: ?

Defined in: xsd/niem/biometrics/1.0/biometrics.xsd

Special Characters: *n/a*

Maximum Length: 2

Maximum Occurrences: 1

Regular Expression: *n/a*

Namespace: <http://niem.gov/niem/biometrics/1.0>

Dependency table

Type of dependency	Value
Optional on Value of other Field, should not be set otherwise.	[9/PAT/GCF]IN{"AU","WU"}

XPath

```
/itl:PackageMinutiaeRecord
  ↳/biom:ExtendedFeatureSetMinutiae
    ↳/biom:FingerprintPatternClassification
      ↳/biom:FingerprintPatternSubClassCode
```

Summary

Sub-classification of arch/whorl.

Valid Examples

<biom:FingerprintPatternSubClassCode>PW</biom:FingerprintPatternSubClassCode>

10.72. Whorl-Delta Relationship - WDR

FingerprintPatternWhorlDeltaRelationshipCode

<p>Field Reference: 9/PAT/WDR Content Type: Data XML Tag Name: FingerprintPatternWhorlDeltaRelationshipCode Data Type: A Minimum Length: 1 Minimum Occurrences: 0 Value range: <i>n/a</i> Code table: see table A.44 Base type: biom:FingerprintPatternWhorlDeltaRelationshipCodeType</p>	<p>Field ID: [09.307-C] Condition: ? Defined in: xsd/niem/biometrics/1.0/biometrics.xsd Special Characters: <i>n/a</i> Maximum Length: 1 Maximum Occurrences: 1 Regular Expression: <i>n/a</i> Namespace: http://niem.gov/niem/biometrics/1.0</p>
--	--

Dependency table

Type of dependency	Value
Optional on Value of other Field, should not be set otherwise.	[9/PAT/SUB]IN{"PW","CP","DL","AW"}

XPath

```

/itl:PackageMinutiaeRecord
└─/biom:ExtendedFeatureSetMinutiae
   └─/biom:FingerprintPatternClassification
      └─/biom:FingerprintPatternWhorlDeltaRelationshipCode
    
```

Summary

Whorl-delta relationship.

Valid Examples

```
<biom:FingerprintPatternWhorlDeltaRelationshipCode>M</biom:FingerprintPatternWhorlDeltaRelationshipCode>
```

10.73. EFS Ridge Quality Map (XML) - RQM

Field Reference: 9/RQM:X

Content Type: Data_X

XML Tag Name: MinutiaeRidgeQualityMapRowText

Data Type: AN

Minimum Length: 1

Minimum Occurrences: 0

Value range: *n/a*

Code table: see table A.56*

Base type: nc:TextType

Field ID: [09.308:X]

Condition: Dependent (see table)

Defined in: xsd/niem/biometrics/1.0/biometrics.xsd

Special Characters: *n/a*

Maximum Length: 50000

Maximum Occurrences: *

Regular Expression: *n/a*

Namespace: <http://niem.gov/niem/biometrics/1.0>

Exceptions

see Technical Notes below

Dependency table

Type of dependency	Value
Optional on Presence of other Field	9/ROI
Mandatory on Value of other Field, optional otherwise.	[9/FSP]=3

XPath

```
/itl:PackageMinutiaeRecord
  ↳/biom:ExtendedFeatureSetMinutiae
    ↳/biom:MinutiaeRidgeQualityMap
      ↳/biom:MinutiaeRidgeQualityMapRowText
```

Summary

EFS local friction ridge quality map used to assess confidence of areas in an image.

Notes

This optional field is comprised of a repeating set of values. The number of subfields corresponds to the number of cells in a column of the image. The quality of each cell will be represented with a local quality value 0 through 5 representing the quality of ridge detail in that cell, as specified in Table 33 in ANIS/NIST. If a region of interest is defined, cells outside of the ROI polygon shall be set to a local quality value of 0 (black). Each row value is encoded as shown in Table 34 in ANIS/NIST. See Field 9.309 for the definition of the grid size and data representation.

Technical Notes

If 9/RQF/RDF="UNC", permissible characters are [0..5]; otherwise permissible characters are [0..9][A"..F"], coincidentally the same as hexadecimal.

*The code table is applies only to some of the characters of the field.

10.74. Ridge Quality Map Format (XML) - RQF

Field Reference: 9/RQF:X	Field ID: [09.309:X]
Content Type: Set_X	Condition: Dependent (see table)
XML Tag Name: MinutiaeRidgeQualityMap	Defined in: xsd/niem/biometrics/1.0/biometrics.xsd
Data Type:	Special Characters: <i>n/a</i>
Minimum Length:	Maximum Length:
Minimum Occurrences: 0	Maximum Occurrences: 1
Value range: <i>n/a</i>	Regular Expression: <i>n/a</i>
Code table: <i>n/a</i>	
Base type: biom:MinutiaeRidgeQualityMapType	Namespace: http://niem.gov/niem/biometrics/1.0

Dependency table

Type of dependency	Value
Mandatory on Presence of other Field	9/RQM:X

XPath

```
/it1:PackageMinutiaeRecord
  ↙/biom:ExtendedFeatureSetMinutiae
    ↙/biom:MinutiaeRidgeQualityMap
```

Summary

Grid size or data representation format used in 9.308.

10.75. Grid Size - GSZ

Field Reference: 9/RQF/GSZ

Content Type: Data

XML Tag Name: MinutiaeRidgeQualityMapCellSizeValue

Data Type: N

Minimum Length: 1

Minimum Occurrences: 1

Value range: {1..41}

Code table: *n/a*

Base type: biom:MapSamplingFrequencyValueType

Field ID: [09.309-A]

Condition: Mandatory within a field

Defined in: xsd/niem/biometrics/1.0/biometrics.xsd

Special Characters: *n/a*

Maximum Length: 2

Maximum Occurrences: 1

Regular Expression: *n/a*

Namespace: <http://niem.gov/niem/biometrics/1.0>

XPath

```
/itl:PackageMinutiaeRecord
  ↳/biom:ExtendedFeatureSetMinutiae
    ↳/biom:MinutiaeRidgeQualityMap
      ↳/biom:MinutiaeRidgeQualityMapCellSizeValue
```

Summary

Grid sizes including horizontal and vertical dimensions of a single cell in the grid. Valid settings range from "1" (0.01 mm) through "41" (0.41 mm). The recommended grid size is 0.20mm (0.008") - note this is 4 pixels at 500 ppi, or 8 pixels at 1000 ppi.

Valid Examples

```
<biom:MinutiaeRidgeQualityMapCellSizeValue>39</biom:MinutiaeRidgeQualityMapCellSizeValue>
```

10.76. Ridge Quality Data Format - RDF

Field Reference: 9/RQF/RDF	Field ID: [09.309-B]
Content Type: Data	Condition: Mandatory within a field
XML Tag Name: MinutiaeRidgeQualityMapFormatCode	Defined in: xsd/niem/biometrics/1.0/biometrics.xsd
Data Type: A	Special Characters: <i>n/a</i>
Minimum Length: 3	Maximum Length: 3
Minimum Occurrences: 1	Maximum Occurrences: 1
Value range: <i>n/a</i>	Regular Expression: <i>n/a</i>
Code table: see table A.55	
Base type: biom:MinutiaeRidgeQualityMapFormatCodeType	Namespace: http://niem.gov/niem/biometrics/1.0

XPath

```

/it1:PackageMinutiaeRecord
  ↙/biom:ExtendedFeatureSetMinutiae
    ↙/biom:MinutiaeRidgeQualityMap
      ↙/biom:MinutiaeRidgeQualityMapFormatCode

```

Summary

Data format used in 9.308.

Notes

The first cell starts at the top left corner of the Region of Interest, with cells in order left to right. • All of the quality values for each row are stored in one repeating subfield. • The subfields are ordered from top to bottom • If the width and/or height of the Region of Interest are not evenly divisible by the Grid Size, partial cells shall be included at the right and/or bottom of the ridge flow map.

Valid Examples

```
<biom:MinutiaeRidgeQualityMapFormatCode>RLE</biom:MinutiaeRidgeQualityMapFormatCode>
```

10.77. EFS Ridge Flow Map (XML) - RFM

Field Reference: 9/RFM:X	Field ID: [09.310:X]
Content Type: Data_X	Condition: Mandatory
XML Tag Name: MinutiaeRidgeFlowMapRowText	Defined in: xsd/niem/biometrics/1.0/biometrics.xsd
Data Type: AN	Special Characters: n/a
Minimum Length: 1	Maximum Length: 100000
Minimum Occurrences: 1	Maximum Occurrences: *
Value range: n/a	Regular Expression: n/a
Code table: n/a	
Base type: nc:TextType	Namespace: http://niem.gov/niem/biometrics/1.0

Exceptions
see Technical Notes below

Dependency table	
Type of dependency	Value
Mandatory on Value of other Field, optional otherwise.	[9/FSP]=3

XPath

```
/itl:PackageMinutiaeRecord
  ↙/biom:ExtendedFeatureSetMinutiae
    ↙/biom:MinutiaeRidgeFlowMap
      ↙/biom:MinutiaeRidgeFlowMapRowText
```

Summary

Direction of friction ridges at points throughout EFS region of interest.

Notes

The number of occurrences must either be 0 or (9/EHI divided by 9/RFF/SFQ). If 9/RFF/RDF="UNC", the length of each value must be (2 * 9/EWI divided by 9/RFF/SFQ); otherwise (9/RFF/RDF="B64"), the length of each value must be (9/EWI divided by 9/RFF/SFQ). The first sampling point in the image is the top left-most point in the region of interest. The same sampling frequency is used both horizontally and vertically. Values shall be included for all sampling points in the region of interest, even if the sampling points are at the edge of the region of interest. For each sampling point, angles shall be reported in integer degrees, with 0 degrees to the right (horizontal), increasing counterclockwise to a maximum value of 179° (since 180°=0°). Undefined angles are recorded in Field 9.311: EFS ridge flow map format / RFF. Each subfield corresponds to one row of the map in order from top to bottom.

Technical Notes

If 9/RFF/RDF="UNC", the DataType is H (hexadecimal), otherwise Base64.

Valid Examples

```
<biom:MinutiaeRidgeFlowMapRowText>UNC</biom:MinutiaeRidgeFlowMapRowText>
```

10.78. EFS Ridge Flow Map Format (XML) - RFF

Field Reference: 9/RFF:X	Field ID: [09.311:X]
Content Type: Set_X	Condition: Dependent (see table)
XML Tag Name: MinutiaeRidgeFlowMap	Defined in: xsd/niem/biometrics/1.0/biometrics.xsd
Data Type:	Special Characters: n/a
Minimum Length:	Maximum Length:
Minimum Occurrences: 0	Maximum Occurrences: 1
Value range: n/a	Regular Expression: n/a
Code table: n/a	
Base type: biom:MinutiaeRidgeFlowMapType	Namespace: http://niem.gov/niem/biometrics/1.0

Dependency table

Type of dependency	Value
Optional on Presence of other Field	9/RFM:X

XPath

```

/it1:PackageMinutiaeRecord
  ↙/biom:ExtendedFeatureSetMinutiae
    ↙/biom:MinutiaeRidgeFlowMap
    
```

Summary

EFS ridge flow map format used for 9.310 for values other than the defaults.

10.79. Sampling Frequency - SFQ

Field Reference: 9/RFF/SFQ

Content Type: Data

XML Tag Name: MinutiaeRidgeFlowMapSamplingFrequencyValue

Data Type: N

Minimum Length: 1

Minimum Occurrences: 1

Value range: {1..41}

Code table: *n/a*

Base type: biom:MapSamplingFrequencyValueType

Field ID: [09.311-A]

Condition: Mandatory within a field

Defined in: xsd/niem/biometrics/1.0/biometrics.xsd

Special Characters: *n/a*

Maximum Length: 2

Maximum Occurrences: 1

Regular Expression: *n/a*

Namespace: <http://niem.gov/niem/biometrics/1.0>

Exceptions

see Technical Notes below

XPath

```
/itl:PackageMinutiaeRecord
└─/biom:ExtendedFeatureSetMinutiae
  └─/biom:MinutiaeRidgeFlowMap
    └─/biom:MinutiaeRidgeFlowMapSamplingFrequencyValue
```

Summary

Optional field permits setting the sampling frequency or data representation format used in the Field 9.310: EFS ridge flow map / RFM to values other than the defaults.

Technical Notes

Default value is "41".

Valid Examples

```
<biom:MinutiaeRidgeFlowMapSamplingFrequencyValue>15</biom:MinutiaeRidgeFlowMapSamplingFrequencyValue>
```

10.80. Ridge Flow Data Format - RDF

Field Reference: 9/RFF/RDF
Content Type: Data
XML Tag Name: MinutiaeRidgeFlowMapFormatCode
Data Type: AN
Minimum Length: 3
Minimum Occurrences: 1
Value range: *n/a*
Code table: see table [A.54](#)
Base type: biom:MinutiaeRidgeFlowMapFormatCodeType

Field ID: [09.311-B]
Condition: Mandatory within a field
Defined in: xsd/niem/biometrics/1.0/biometrics.xsd
Special Characters: *n/a*
Maximum Length: 3
Maximum Occurrences: 1
Regular Expression: *n/a*
Namespace: <http://niem.gov/niem/biometrics/1.0>

Exceptions

see Technical Notes below

XPath

```
/it1:PackageMinutiaeRecord  
  ↳/biom:ExtendedFeatureSetMinutiae  
    ↳/biom:MinutiaeRidgeFlowMap  
      ↳/biom:MinutiaeRidgeFlowMapFormatCode
```

Summary

Format (uncompressed or base-64) used in Ridge Flow Map field.

Technical Notes

Default value is "UNC".

Valid Examples

```
<biom:MinutiaeRidgeFlowMapFormatCode>UNC</biom:MinutiaeRidgeFlowMapFormatCode>
```

10.81. EFS Ridge Wavelength Map (XML) - RWM

<p>Field Reference: 9/RWM:X Content Type: Data_X XML Tag Name: MinutiaeRidgeWavelengthMapRowText Data Type: AN Minimum Length: 1 Minimum Occurrences: 1 Value range: <i>n/a</i> Code table: <i>n/a</i> Base type: nc:TextType</p>	<p>Field ID: [09.312:X] Condition: Dependent (see table) Defined in: xsd/niem/biometrics/1.0/biometrics.xsd Special Characters: <i>n/a</i> Maximum Length: 100000 Maximum Occurrences: * Regular Expression: <i>n/a</i></p> <p>Namespace: http://niem.gov/niem/biometrics/1.0</p>
--	---

Exceptions
 see Technical Notes below

Dependency table

Type of dependency	Value
Optional on Presence of other Field	9/RWF:X

XPath

```
/itl:PackageMinutiaeRecord
  ↙/biom:ExtendedFeatureSetMinutiae
    ↙/biom:MinutiaeRidgeWavelengthMap
      ↙/biom:MinutiaeRidgeWavelengthMapRowText
```

Summary

Peak-to-peak distance between ridges at various sampling points throughout the EFS region of interest.

Notes

The sampling frequency is optionally defined in Field 9.313. For each sampling point in the Region of Interest, distances between ridge peaks, measured perpendicular to ridge flow, shall be reported in 2-character decimal format using units of 10 micrometers (0.01 mm). Unknown values shall be set to "XX". Valid values are therefore "01" (0.01 mm) through "99" (0.99 mm or greater). (In practice, the actual stored values are likely to be "30" to "70" in most cases (0.3 - 0.7 mm). The 2-character decimal wavelength values for each sampling point are concatenated left to right for all sampling points in a row. Each subfield corresponds to one row of the map, in order from top to bottom.

Technical Notes

The number of occurrences must either be 0 or (9/EHI divided by 9/RWF/FWS). The length of each value must be (2 * 9/EWI divided by 9/RWF/FWS). Valid characters are [0..9]["X"].

10.82. EFS Ridge Wavelength Map Format (XML) - RWF

Field Reference: 9/RWF:X	Field ID: [09.313:X]
Content Type: Set_X	Condition: Dependent (see table)
XML Tag Name: MinutiaeRidgeWavelengthMap	Defined in: xsd/niem/biometrics/1.0/biometrics.xsd
Data Type:	Special Characters: <i>n/a</i>
Minimum Length:	Maximum Length:
Minimum Occurrences: 0	Maximum Occurrences: 1
Value range: <i>n/a</i>	Regular Expression: <i>n/a</i>
Code table: <i>n/a</i>	
Base type: biom:MinutiaeRidgeWavelengthMapType	Namespace: http://niem.gov/niem/biometrics/1.0

Dependency table

Type of dependency	Value
Optional on Presence of other Field	9/RWM:X

XPath

```

/it1:PackageMinutiaeRecord
├─/biom:ExtendedFeatureSetMinutiae
│  └─/biom:MinutiaeRidgeWavelengthMap
    
```

Summary

EFS ridge flow map format used for 9.312 for values other than the defaults.

10.83. Sampling Frequency - FWS

Field Reference: 9/RWF/FWS

Content Type: Data

XML Tag Name: MinutiaeRidgeWavelengthMapSamplingFrequencyValue

Data Type: N

Minimum Length: 1

Minimum Occurrences: 1

Value range: {1..41}

Code table: *n/a*

Base type: biom:MapSamplingFrequencyValueType

Field ID: [09.313-A]

Condition: Mandatory within a field

Defined in: xsd/niem/biometrics/1.0/biometrics.xsd

Special Characters: *n/a*

Maximum Length: 2

Maximum Occurrences: 1

Regular Expression: *n/a*

Namespace: <http://niem.gov/niem/biometrics/1.0>

Exceptions

see Technical Notes below

XPath

```
/it1:PackageMinutiaeRecord
  ↳/biom:ExtendedFeatureSetMinutiae
    ↳/biom:MinutiaeRidgeWavelengthMap
      ↳/biom:MinutiaeRidgeWavelengthMapSamplingFrequencyValue
```

Summary

Permits setting the sampling frequency or data representation format used in Field 9.312: EFS ridge wavelength map / RWM to values other than the defaults, and is conditional on the presence of Field 9.312.

Technical Notes

Default value is "41".

Valid Examples

```
<biom:MinutiaeRidgeWavelengthMapSamplingFrequencyValue>2</biom:MinutiaeRidgeWavelengthMapSamplingFrequencyValue>
```

10.84. Data Format - FDF

Field Reference: 9/RWF/FDF	Field ID: [09.313-B]
Content Type: Data	Condition: Mandatory within a field
XML Tag Name: MinutiaeRidgeWavelengthMapFormatCode	Defined in: xsd/niem/biometrics/1.0/biometrics.xsd
Data Type: A	Special Characters: <i>n/a</i>
Minimum Length: 3	Maximum Length: 3
Minimum Occurrences: 1	Maximum Occurrences: 1
Value range: {"UNC"}	Regular Expression: <i>n/a</i>
Code table: <i>n/a</i>	
Base type: biom:MinutiaeRidgeWavelengthMapFormatCodeType	Namespace: http://niem.gov/niem/biometrics/1.0

Exceptions

see Technical Notes below

XPath

```
/it1:PackageMinutiaeRecord
├─/biom:ExtendedFeatureSetMinutiae
│   └─/biom:MinutiaeRidgeWavelengthMap
│       └─/biom:MinutiaeRidgeWavelengthMapFormatCode
```

Summary

Format (uncompressed or base-64) used in 9.312.

Technical Notes

Default value is "UNC".

Valid Examples

```
<biom:MinutiaeRidgeWavelengthMapFormatCode>UNC</biom:MinutiaeRidgeWavelengthMapFormatCode>
```

10.85. EFS Tonal Reversal - TRV

Field Reference: 9/TRV

Content Type: Data

XML Tag Name: FrictionRidgeImageTonalReversalCode

Data Type: A

Minimum Length: 1

Minimum Occurrences: 0

Value range: *n/a*

Code table: see table [A.61](#)

Base type: biom:FrictionRidgeImageTonalReversalCodeType

Field ID: [09.314]

Condition: Dependent (see table)

Defined in: xsd/niem/biometrics/1.0/biometrics.xsd

Special Characters: *n/a*

Maximum Length: 1

Maximum Occurrences: 1

Regular Expression: *n/a*

Namespace: <http://niem.gov/niem/biometrics/1.0>

Dependency table

Type of dependency	Value
Optional on Presence of other Field	9/ROI

XPath

```
/itl:PackageMinutiaeRecord
  ↳/biom:ExtendedFeatureSetMinutiae
    ↳/biom:FrictionRidgeImageTonalReversalCode
```

Summary

Indicates whether all or part of an EFS image is tonally reversed. If no part of the image is tonally reversed, field is omitted.

Valid Examples

```
<biom:FrictionRidgeImageTonalReversalCode>N</biom:FrictionRidgeImageTonalReversalCode>
```

10.86. EFS Possible Lateral Reversal - PLR

Field Reference: 9/PLR	Field ID: [09.315]
Content Type: Data	Condition: Dependent (see table)
XML Tag Name: FrictionRidgeImageLateralReversalCode	Defined in: xsd/niem/biometrics/1.0/biometrics.xsd
Data Type: A	Special Characters: <i>n/a</i>
Minimum Length: 1	Maximum Length: 1
Minimum Occurrences: 0	Maximum Occurrences: 1
Value range: <i>n/a</i>	Regular Expression: <i>n/a</i>
Code table: see table A.46	
Base type: biom:FrictionRidgeImageLateralReversalCodeType	Namespace: http://niem.gov/niem/biometrics/1.0

Dependency table

Type of dependency	Value
Optional on Presence of other Field	9/ROI

XPath

```
/itl:PackageMinutiaeRecord
  ↳/biom:ExtendedFeatureSetMinutiae
    ↳/biom:FrictionRidgeImageLateralReversalCode
```

Summary

Indicates whether the image is or may be laterally reversed (flipped left-right). If image was not reversed, field is omitted.

Valid Examples

```
<biom:FrictionRidgeImageLateralReversalCode>A</biom:FrictionRidgeImageLateralReversalCode>
```

10.87. EFS Friction Ridge Quality Metric - FQM

Field Reference: 9/FQM

Content Type: Set

XML Tag Name: ImageQuality

Data Type:

Minimum Length:

Minimum Occurrences: 0

Value range: *n/a*

Code table: *n/a*

Base type: biom:ImageQualityType

Field ID: [09.316]

Condition: Dependent (see table)

Defined in: xsd/niem/biometrics/1.0/biometrics.xsd

Special Characters: *n/a*

Maximum Length:

Maximum Occurrences: 9

Regular Expression: *n/a*

Namespace: <http://niem.gov/niem/biometrics/1.0>

Dependency table

Type of dependency	Value
Optional on Presence of other Field	9/ROI

XPath

```
/it1:PackageMinutiaeRecord
  ↙/biom:ExtendedFeatureSetMinutiae
    ↙/biom:ImageQuality
```

Summary

Specifies one or more different metrics of EFS friction ridge quality for image.

10.88. Quality Value - QVU

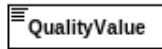

Field Reference: 9/FQM/QVU
Content Type: Data
XML Tag Name: QualityValue
Data Type: N
Minimum Length: 1
Minimum Occurrences: 1
Value range: {0..100,254,255}
Code table: see table [A.48](#) *
Base type: niem-xsd:integer

Field ID: [09.316-A]
Condition: Mandatory within a field
Defined in: xsd/niem/biometrics/1.0/biometrics.xsd
Special Characters: *n/a*
Maximum Length: 3
Maximum Occurrences: 1
Regular Expression: *n/a*

Namespace: <http://niem.gov/niem/biometrics/1.0>

XPath

```

/itl:PackageMinutiaeRecord
├─/biom:ExtendedFeatureSetMinutiae
│   └─/biom:ImageQuality
│       └─/biom:QualityValue
  
```

Summary

Quantitative expression of predicted matching performance of biometric sample. This information item shall contain the integer image quality score between 0 and 100 (inclusive) assigned to the image data by a quality algorithm. Higher values indicate better quality.

Valid Examples

```
<biom:QualityValue>100</biom:QualityValue>
```

*The code table is optional, defining commonly-used or special-purpose values, rather than definitive (listing all possible values).

10.89. Algorithm Vendor Identification - QAV

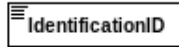

Field Reference: 9/FQM/QAV
Content Type: Data
XML Tag Name: IdentificationID
Data Type: H
Minimum Length: 4
Minimum Occurrences: 1
Value range: *n/a*
Code table: *n/a*
Base type: niem-xsd:string

Field ID: [09.316-B]
Condition: Mandatory within a field
Defined in: xsd/niem/niem-core/2.0/niem-core.xsd
Special Characters: *n/a*
Maximum Length: 4
Maximum Occurrences: 1
Regular Expression: *n/a*

Namespace: <http://niem.gov/niem/niem-core/2.0>

XPath

```

/itl:PackageMinutiaeRecord
  ↳/biom:ExtendedFeatureSetMinutiae
    ↳/biom:ImageQuality
      ↳/biom:QualityAlgorithmVendorIdentification
        ↳/nc:IdentificationID
  
```

Summary

ID of the vendor of the quality algorithm used to calculate the quality score. This value is assigned by IBIA, which maintains the Vendor Registry of CBEFF Biometric Organizations that map the value in this field to a registered organization.

Valid Examples

```
<nc:IdentificationID>FFF0</nc:IdentificationID>
```

10.90. Algorithm Product Identification - QAP

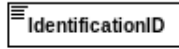

Field Reference: 9/FQM/QAP
Content Type: Data
XML Tag Name: IdentificationID
Data Type: N
Minimum Length: 1
Minimum Occurrences: 1
Value range: {1..65535}
Code table: *n/a*
Base type: niem-xsd:string

Field ID: [09.316-C]
Condition: Mandatory within a field
Defined in: xsd/niem/niem-core/2.0/niem-core.xsd
Special Characters: *n/a*
Maximum Length: 5
Maximum Occurrences: 1
Regular Expression: *n/a*

Namespace: <http://niem.gov/niem/niem-core/2.0>

XPath

```
/itl:PackageMinutiaeRecord  
  ↳/biom:ExtendedFeatureSetMinutiae  
    ↳/biom:ImageQuality  
      ↳/biom:QualityAlgorithmProductIdentification  
        ↳/nc:IdentificationID
```

Summary

Numeric product code assigned by the vendor of the quality algorithm (may be registered with the IBIA, but registration is not required).

Valid Examples

```
<nc:IdentificationID>28495</nc:IdentificationID>
```

10.91. EFS Possible Growth or Shrinkage - PGS

Field Reference: 9/PGS	Field ID: [09.317]
Content Type: Set	Condition: Dependent (see table)
XML Tag Name: MinutiaeGrowthOrShrinkage	Defined in: xsd/niem/biometrics/1.0/biometrics.xsd
Data Type:	Special Characters: <i>n/a</i>
Minimum Length:	Maximum Length:
Minimum Occurrences: 0	Maximum Occurrences: 1
Value range: <i>n/a</i>	Regular Expression: <i>n/a</i>
Code table: <i>n/a</i>	
Base type: biom:MinutiaeGrowthOrShrinkageType	Namespace: http://niem.gov/niem/biometrics/1.0

Dependency table

Type of dependency	Value
Optional on Presence of other Field	9/ROI

XPath

```

/it1:PackageMinutiaeRecord
  ↙/biom:ExtendedFeatureSetMinutiae
    ↙/biom:MinutiaeGrowthOrShrinkage
    
```

Summary

For EFS friction ridge impressions that have changed size or scale (e.g., swollen skin from water exposure). This field acts as a flag to indicate that greater than ordinary dimensional variation should be expected in performing subsequent comparisons.

10.92. Growth or Shrinkage Type - TGS

Field Reference: 9/PGS/TGS

Content Type: Data

XML Tag Name: MinutiaeGrowthOrShrinkageCode

Data Type: A

Minimum Length: 1

Minimum Occurrences: 1

Value range: *n/a*

Code table: see table [A.45](#)

Base type: biom:MinutiaeGrowthOrShrinkageCodeType

Field ID: [09.317-A]

Condition: Mandatory within a field

Defined in: [xsd/niem/biometrics/1.0/biometrics.xsd](#)

Special Characters: *n/a*

Maximum Length: 1

Maximum Occurrences: 1

Regular Expression: *n/a*

Namespace: <http://niem.gov/niem/biometrics/1.0>

XPath

```
/it1:PackageMinutiaeRecord
  ↳/biom:ExtendedFeatureSetMinutiae
    ↳/biom:MinutiaeGrowthOrShrinkage
      ↳/biom:MinutiaeGrowthOrShrinkageCode
```

Summary

Code for type of growth or shrinkage.

Valid Examples

```
<biom:MinutiaeGrowthOrShrinkageCode>G</biom:MinutiaeGrowthOrShrinkageCode>
```

10.93. Growth or Shrinkage Comment (XML) - CGS

Field Reference: 9/PGS/CGS:X
Content Type: Data_X
XML Tag Name: MinutiaeCommentText
Data Type: U
Minimum Length: 1
Minimum Occurrences: 0
Value range: *n/a*
Code table: *n/a*
Base type: nc:TextType

Field ID: [09.317-B:X]
Condition: Optional within a field
Defined in: xsd/niem/biometrics/1.0/biometrics.xsd
Special Characters: *n/a*
Maximum Length: 1000
Maximum Occurrences: 1
Regular Expression: *n/a*
Namespace: <http://niem.gov/niem/biometrics/1.0>

XPath

```
/it1:PackageMinutiaeRecord  
  ↙/biom:ExtendedFeatureSetMinutiae  
    ↙/biom:MinutiaeGrowthOrShrinkage  
      ↙/biom:MinutiaeCommentText
```

Summary

Rationale for believing growth or shrinkage may have occurred.

10.94. EFS Cores (XML) - COR

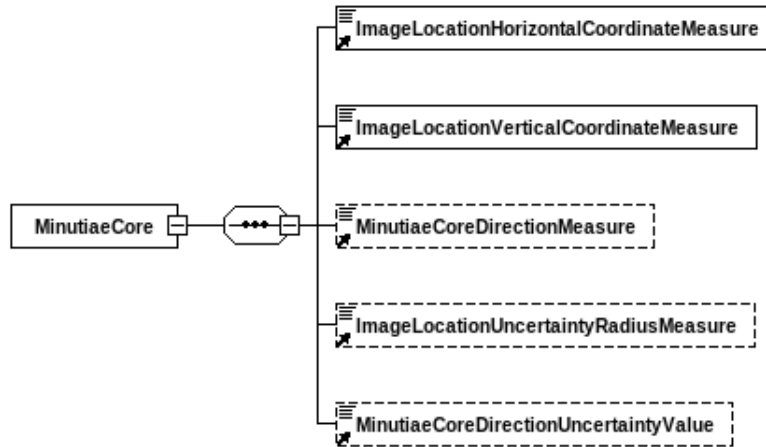

Field Reference: 9/COR:X
Content Type: Set_X
XML Tag Name: MinutiaeCore
Data Type:
Minimum Length:
Minimum Occurrences: 0
Value range: n/a
Code table: n/a
Base type: biom:MinutiaeCoreType

Field ID: [09.320:X]
Condition: Dependent (see table)
Defined in: xsd/niem/biometrics/1.0/biometrics.xsd
Special Characters: n/a
Maximum Length:
Maximum Occurrences: *
Regular Expression: n/a
Namespace: <http://niem.gov/niem/biometrics/1.0>

Exceptions

see Technical Notes below

Dependency table

Type of dependency	Value
Mandatory on Absence of other Field	9/NCOR:X

XPath

```

/itl:PackageMinutiaeRecord
  ↙/biom:ExtendedFeatureSetMinutiae
    ↙/biom:MinutiaeCore
    
```

Summary

EFS core information. When no cores are present, this field shall not be used.

Technical Notes

If palm/plantar 9/FPP/FGP>=18, MaxOccur=*; if 9/PAT/SUB="AW", MaxOccur=*; if 9/PAT/SUB="PA", MaxOccur=0; if 9/PAT/SUB="TA", MaxOccur=1; if 9/PAT/GCF="LS" or "RS", MaxOccur=1; if 9/PAT/GCF="WU", MaxOccur=2.

10.95. X Coordinate - CXC

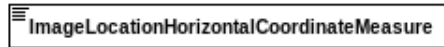

Field Reference: 9/COR/CXC

Content Type: Data

XML Tag Name: ImageLocationHorizontalCoordinateMeasure

Data Type: N

Minimum Length: 1

Minimum Occurrences: 1

Value range: *n/a*

Code table: *n/a*

Base type: niem-xsd:integer

Field ID: [09.320-A]

Condition: Mandatory within a field

Defined in: xsd/niem/biometrics/1.0/biometrics.xsd

Special Characters: *n/a*

Maximum Length: 5

Maximum Occurrences: 1

Regular Expression: *n/a*

Namespace: <http://niem.gov/niem/biometrics/1.0>

XPath

```
/itl:PackageMinutiaeRecord  
  ↳/biom:ExtendedFeatureSetMinutiae  
    ↳/biom:MinutiaeCore  
      ↳/biom:ImageLocationHorizontalCoordinateMeasure
```

Summary

X coordinate of core (integer units of 10 micrometers).

Valid Examples

```
<biom:ImageLocationHorizontalCoordinateMeasure>4970</biom:ImageLocationHorizontalCoordinateMeasure>
```

10.96. Y Coordinate - CYC

 ImageLocationVerticalCoordinateMeasure
--

Field Reference: 9/COR/CYC

Content Type: Data

XML Tag Name: ImageLocationVerticalCoordinateMeasure

Data Type: N

Minimum Length: 1

Minimum Occurrences: 1

Value range: *n/a*

Code table: *n/a*

Base type: niem-xsd:integer

Field ID: [09.320-B]

Condition: Mandatory within a field

Defined in: xsd/niem/biometrics/1.0/biometrics.xsd

Special Characters: *n/a*

Maximum Length: 5

Maximum Occurrences: 1

Regular Expression: *n/a*

Namespace: <http://niem.gov/niem/biometrics/1.0>

XPath

```
/itl:PackageMinutiaeRecord
  ↳/biom:ExtendedFeatureSetMinutiae
    ↳/biom:MinutiaeCore
      ↳/biom:ImageLocationVerticalCoordinateMeasure
```

Summary

Y coordinate of core (integer units of 10 micrometers).

Valid Examples

<code><biom:ImageLocationVerticalCoordinateMeasure>4970</biom:ImageLocationVerticalCoordinateMeasure></code>
--

10.97. Direction - CDI

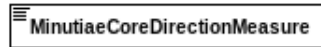

Field Reference: 9/COR/CDI

Content Type: Data

XML Tag Name: MinutiaeCoreDirectionMeasure

Data Type: NS

Minimum Length: 1

Minimum Occurrences: 0

Value range: {-179..180}

Code table: *n/a*

Base type: biom:DirectionMeasureType

Field ID: [09.320-C]

Condition: Optional within a field

Defined in: xsd/niem/biometrics/1.0/biometrics.xsd

Special Characters: [-]

Maximum Length: 4

Maximum Occurrences: 1

Regular Expression: *n/a*

Namespace: <http://niem.gov/niem/biometrics/1.0>

XPath

```
/itl:PackageMinutiaeRecord
  ↳/biom:ExtendedFeatureSetMinutiae
    ↳/biom:MinutiaeCore
      ↳/biom:MinutiaeCoreDirectionMeasure
```

Summary

Average tangent direction of two closest friction ridges. The direction shall be omitted for circular whorls, or if the direction is unknown.

Valid Examples

```
<biom:MinutiaeCoreDirectionMeasure>110</biom:MinutiaeCoreDirectionMeasure>
```

10.98. Radius of Position Uncertainty - RPU

Field Reference: 9/COR/RPU

Content Type: Data

XML Tag Name: ImageLocationUncertaintyRadiusMeasure

Data Type: N

Minimum Length: 1

Minimum Occurrences: 0

Value range: {0..999}

Code table: *n/a*

Base type: niem-xsd:nonNegativeInteger

Field ID: [09.320-D]

Condition: Optional within a field

Defined in: xsd/niem/biometrics/1.0/biometrics.xsd

Special Characters: *n/a*

Maximum Length: 3

Maximum Occurrences: 1

Regular Expression: *n/a*

Namespace: <http://niem.gov/niem/biometrics/1.0>

XPath

```
/itl:PackageMinutiaeRecord
  ↳/biom:ExtendedFeatureSetMinutiae
    ↳/biom:MinutiaeCore
      ↳/biom:ImageLocationUncertaintyRadiusMeasure
```

Summary

Radius of a circle sized to include the area of possible locations of the core; used if the precise location cannot be determined (such as due to poor clarity). If the core location is known precisely, the radius of position uncertainty may be omitted or set to 0.

Valid Examples

```
<biom:ImageLocationUncertaintyRadiusMeasure>80</biom:ImageLocationUncertaintyRadiusMeasure>
```

10.99. Direction Uncertainty - DUY

Field Reference: 9/COR/DUY

Content Type: Data

XML Tag Name: MinutiaeCoreDirectionUncertaintyValue

Data Type: N

Minimum Length: 1

Minimum Occurrences: 0

Value range: {0..180}

Code table: see table [A.2](#) *

Base type: biom:UncertaintyValueType

Field ID: [09.320-E]

Condition: Optional within a field

Defined in: xsd/niem/biometrics/1.0/biometrics.xsd

Special Characters: n/a

Maximum Length: 3

Maximum Occurrences: 1

Regular Expression: n/a

Namespace: <http://niem.gov/niem/biometrics/1.0>

XPath

```
/itl:PackageMinutiaeRecord
  ↳/biom:ExtendedFeatureSetMinutiae
    ↳/biom:MinutiaeCore
      ↳/biom:MinutiaeCoreDirectionUncertaintyValue
```

Summary

Uncertainty of direction of the core ("0" = indicates certain direction; "180" = unknown orientation).

Valid Examples

```
<biom:MinutiaeCoreDirectionUncertaintyValue>75</biom:MinutiaeCoreDirectionUncertaintyValue>
```

*The code table is optional, defining commonly-used or special-purpose values, rather than definitive (listing all possible values).

10.100. EFS Deltas (XML) - DEL

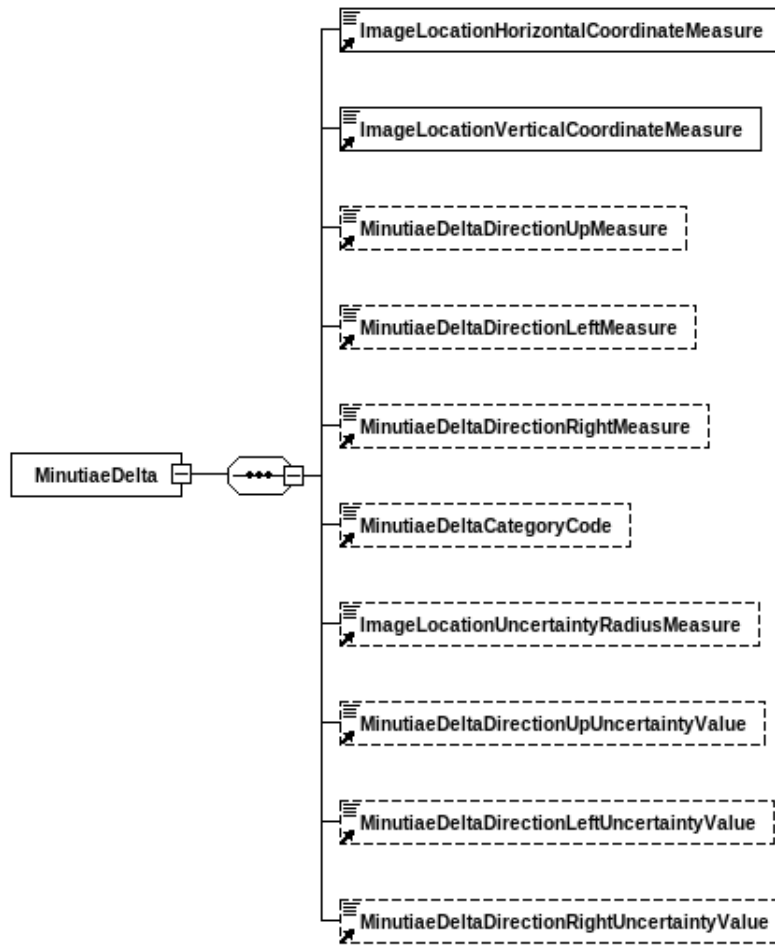

Field Reference: 9/DEL:X
Content Type: Set_X
XML Tag Name: MinutiaeDelta
Data Type:
Minimum Length:
Minimum Occurrences: 0
Value range: n/a
Code table: n/a
Base type: biom:MinutiaeDeltaType

Field ID: [09.321:X]
Condition: Dependent (see table)
Defined in: xsd/niem/biometrics/1.0/biometrics.xsd
Special Characters: n/a
Maximum Length:
Maximum Occurrences: *
Regular Expression: n/a
Namespace: <http://niem.gov/niem/biometrics/1.0>

Exceptions
 see Technical Notes below

Dependency table

Type of dependency	Value
Mandatory on Absence of other Field	9/NDEL:X

XPath

```
/itl:PackageMinutiaeRecord
  ↳/biom:ExtendedFeatureSetMinutiae
    ↳/biom:MinutiaeDelta
```

Summary

EFS delta information.

Notes

For fingerprints, one or more deltas are defined for all pattern classifications other than plain arches. For palm prints or other non-fingerprint friction ridge images, any number of delta-like patterns may be defined using this field if such structures are present.

Technical Notes

If palm/plantar 9/FPP/FGP \geq 18, MaxOccur=*. Otherwise, if 9/PAT/SUB="AW", MaxOccur=*; if 9/PAT/SUB="PA", MaxOccur=0; if 9/PAT/SUB="TA", MaxOccur=1; if 9/PAT/GCF="LS" or "RS", MaxOccur=1; if 9/PAT/GCF="WU", MaxOccur=2.

10.101. X Coordinate - DXC

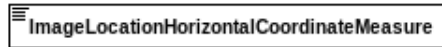

Field Reference: 9/DEL/DXC

Content Type: Data

XML Tag Name: ImageLocationHorizontalCoordinateMeasure

Data Type: N

Minimum Length: 1

Minimum Occurrences: 1

Value range: *n/a*

Code table: *n/a*

Base type: niem-xsd:integer

Field ID: [09.321-A]

Condition: Mandatory within a field

Defined in: xsd/niem/biometrics/1.0/biometrics.xsd

Special Characters: *n/a*

Maximum Length: 5

Maximum Occurrences: 1

Regular Expression: *n/a*

Namespace: <http://niem.gov/niem/biometrics/1.0>

XPath

```
/itl:PackageMinutiaeRecord
  ↳/biom:ExtendedFeatureSetMinutiae
    ↳/biom:MinutiaeDelta
      ↳/biom:ImageLocationHorizontalCoordinateMeasure
```

Summary

X coordinate of delta (units of 10 micrometers).

10.102. Y Coordinate - DYC

 ImageLocationVerticalCoordinateMeasure
--

Field Reference: 9/DEL/DYC

Content Type: Data

XML Tag Name: ImageLocationVerticalCoordinateMeasure

Data Type: N

Minimum Length: 1

Minimum Occurrences: 1

Value range: *n/a*

Code table: *n/a*

Base type: niem-xsd:integer

Field ID: [09.321-B]

Condition: Mandatory within a field

Defined in: xsd/niem/biometrics/1.0/biometrics.xsd

Special Characters: *n/a*

Maximum Length: 5

Maximum Occurrences: 1

Regular Expression: *n/a*

Namespace: <http://niem.gov/niem/biometrics/1.0>

XPath

```

/itl:PackageMinutiaeRecord
  ↳/biom:ExtendedFeatureSetMinutiae
    ↳/biom:MinutiaeDelta
      ↳/biom:ImageLocationVerticalCoordinateMeasure
  
```

Summary

Y coordinate of delta (units of 10 micrometers).

Valid Examples

<pre><biom:ImageLocationVerticalCoordinateMeasure>49700</biom:ImageLocationVerticalCoordinateMeasure></pre>

10.103. Direction Up - DUP

 MinutiaeDeltaDirectionUpMeasure

Field Reference: 9/DEL/DUP
Content Type: Data
XML Tag Name: MinutiaeDeltaDirectionUpMeasure
Data Type: N
Minimum Length: 1
Minimum Occurrences: 0
Value range: {0..180}
Code table: *n/a*
Base type: biom:DeltaDirectionMeasureType

Field ID: [09.321-C]
Condition: Optional within a field
Defined in: xsd/niem/biometrics/1.0/biometrics.xsd
Special Characters: *n/a*
Maximum Length: 3
Maximum Occurrences: 1
Regular Expression: *n/a*
Namespace: <http://niem.gov/niem/biometrics/1.0>

XPath

```
/itl:PackageMinutiaeRecord  
  ↙/biom:ExtendedFeatureSetMinutiae  
    ↙/biom:MinutiaeDelta  
      ↙/biom:MinutiaeDeltaDirectionUpMeasure
```

Summary

Direction up of delta in degrees from right (degrees counterclockwise from the right).

Notes

Information item is allowed to be omitted (left empty).

Valid Examples

<code><biom:MinutiaeDeltaDirectionUpMeasure>49700</biom:MinutiaeDeltaDirectionUpMeasure></code>

10.104. Direction Left - DLF

 MinutiaeDeltaDirectionLeftMeasure

Field Reference: 9/DEL/DLF

Content Type: Data

XML Tag Name: MinutiaeDeltaDirectionLeftMeasure

Data Type: N

Minimum Length: 1

Minimum Occurrences: 0

Value range: {0..180}

Code table: *n/a*

Base type: biom:DeltaDirectionMeasureType

Field ID: [09.321-D]

Condition: Optional within a field

Defined in: xsd/niem/biometrics/1.0/biometrics.xsd

Special Characters: *n/a*

Maximum Length: 3

Maximum Occurrences: 1

Regular Expression: *n/a*

Namespace: <http://niem.gov/niem/biometrics/1.0>

XPath

```
/it1:PackageMinutiaeRecord
  ↳/biom:ExtendedFeatureSetMinutiae
    ↳/biom:MinutiaeDelta
      ↳/biom:MinutiaeDeltaDirectionLeftMeasure
```

Summary

Direction left of delta in degrees from right (degrees counterclockwise from the right).

Notes

Information item is allowed to be omitted (left empty).

Valid Examples

<code><biom:MinutiaeDeltaDirectionLeftMeasure>100</biom:MinutiaeDeltaDirectionLeftMeasure></code>

10.105. Direction Right - DRT

 MinutiaeDeltaDirectionRightMeasure
--

Field Reference: 9/DEL/DRT
Content Type: Data
XML Tag Name: MinutiaeDeltaDirectionRightMeasure
Data Type: N
Minimum Length: 1
Minimum Occurrences: 0
Value range: {0..180}
Code table: *n/a*
Base type: biom:DeltaDirectionMeasureType

Field ID: [09.321-E]
Condition: Optional within a field
Defined in: xsd/niem/biometrics/1.0/biometrics.xsd
Special Characters: *n/a*
Maximum Length: 3
Maximum Occurrences: 1
Regular Expression: *n/a*
Namespace: <http://niem.gov/niem/biometrics/1.0>

XPath

```
/itl:PackageMinutiaeRecord  
  ↙/biom:ExtendedFeatureSetMinutiae  
    ↙/biom:MinutiaeDelta  
      ↙/biom:MinutiaeDeltaDirectionRightMeasure
```

Summary

Direction right of delta in degrees from right (degrees counterclockwise from the right).

Notes

Information item is allowed to be omitted (left empty).

Valid Examples

<code><biom:MinutiaeDeltaDirectionRightMeasure>100</biom:MinutiaeDeltaDirectionRightMeasure></code>

10.106. Type - DTP

Field Reference: 9/DEL/DTP
Content Type: Data
XML Tag Name: MinutiaeDeltaCategoryCode
Data Type: AN
Minimum Length: 1
Minimum Occurrences: 0
Value range: *n/a*
Code table: see table [A.15](#)
Base type: biom:MinutiaeDeltaCategoryCodeType

Field ID: [09.321-F]
Condition: Optional within a field
Defined in: xsd/niem/biometrics/1.0/biometrics.xsd
Special Characters: *n/a*
Maximum Length: 3
Maximum Occurrences: 1
Regular Expression: *n/a*
Namespace: <http://niem.gov/niem/biometrics/1.0>

XPath

```
/it1:PackageMinutiaeRecord  
  ↳/biom:ExtendedFeatureSetMinutiae  
    ↳/biom:MinutiaeDelta  
      ↳/biom:MinutiaeDeltaCategoryCode
```

Summary

Type of delta.

Valid Examples

```
<biom:MinutiaeDeltaCategoryCode>UP</biom:MinutiaeDeltaCategoryCode>
```

10.107. Radius of Position Uncertainty - RPU

Field Reference: 9/DEL/RPU

Content Type: Data

XML Tag Name: ImageLocationUncertaintyRadiusMeasure

Data Type: N

Minimum Length: 1

Minimum Occurrences: 0

Value range: {1..999}

Code table: n/a

Base type: niem-xsd:nonNegativeInteger

Field ID: [09.321-G]

Condition: Optional within a field

Defined in: xsd/niem/biometrics/1.0/biometrics.xsd

Special Characters: n/a

Maximum Length: 3

Maximum Occurrences: 1

Regular Expression: n/a

Namespace: <http://niem.gov/niem/biometrics/1.0>

XPath

```
/itl:PackageMinutiaeRecord
  ↳/biom:ExtendedFeatureSetMinutiae
    ↳/biom:MinutiaeDelta
      ↳/biom:ImageLocationUncertaintyRadiusMeasure
```

Summary

Radius of a circle sized to include the area of possible locations of the delta; used if the precise location cannot be determined (such as due to poor clarity). If the delta location is known precisely, the radius of position uncertainty may be omitted or set to 0.

Valid Examples

```
<biom:ImageLocationUncertaintyRadiusMeasure>180</biom:ImageLocationUncertaintyRadiusMeasure>
```

10.108. Direction Uncertainty Up - DUU

Field Reference: 9/DEL/DUU

Content Type: Data

XML Tag Name: MinutiaeDeltaDirectionUpUncertaintyValue

Data Type: N

Minimum Length: 1

Minimum Occurrences: 0

Value range: {0..180}

Code table: see table [A.2](#) *

Base type: biom:UncertaintyValueType

Field ID: [09.321-H]

Condition: Optional within a field

Defined in: xsd/niem/biometrics/1.0/biometrics.xsd

Special Characters: n/a

Maximum Length: 3

Maximum Occurrences: 1

Regular Expression: n/a

Namespace: <http://niem.gov/niem/biometrics/1.0>

XPath

```
/itl:PackageMinutiaeRecord
  ↳/biom:ExtendedFeatureSetMinutiae
    ↳/biom:MinutiaeDelta
      ↳/biom:MinutiaeDeltaDirectionUpUncertaintyValue
```

Summary

Uncertainty of the up delta angle ("0" = indicates certain direction; "180" = unknown orientation).

Valid Examples

```
<biom:MinutiaeDeltaDirectionUpUncertaintyValue>180</biom:MinutiaeDeltaDirectionUpUncertaintyValue>
```

*The code table is optional, defining commonly-used or special-purpose values, rather than definitive (listing all possible values).

10.109. Direction Uncertainty Left - DUL

Field Reference: 9/DEL/DUL

Content Type: Data

XML Tag Name: MinutiaeDeltaDirectionLeftUncertaintyValue

Data Type: N

Minimum Length: 1

Minimum Occurrences: 0

Value range: {0..180}

Code table: see table [A.2](#) *

Base type: biom:UncertaintyValueType

Field ID: [09.321-I]

Condition: Optional within a field

Defined in: xsd/niem/biometrics/1.0/biometrics.xsd

Special Characters: *n/a*

Maximum Length: 3

Maximum Occurrences: 1

Regular Expression: *n/a*

Namespace: <http://niem.gov/niem/biometrics/1.0>

XPath

```
/itl:PackageMinutiaeRecord
  ↳/biom:ExtendedFeatureSetMinutiae
    ↳/biom:MinutiaeDelta
      ↳/biom:MinutiaeDeltaDirectionLeftUncertaintyValue
```

Summary

Uncertainty of the left delta angle ("0" = indicates certain direction; "180" = unknown orientation).

Valid Examples

```
<biom:MinutiaeDeltaDirectionLeftUncertaintyValue>180</biom:MinutiaeDeltaDirectionLeftUncertaintyValue>
```

*The code table is optional, defining commonly-used or special-purpose values, rather than definitive (listing all possible values).

10.110. Direction Uncertainty Right - DUR

Field Reference: 9/DEL/DUR

Content Type: Data

XML Tag Name: MinutiaeDeltaDirectionRightUncertainty-Value

Data Type: N

Minimum Length: 1

Minimum Occurrences: 0

Value range: {0..180}

Code table: see table [A.2](#) *

Base type: biom:UncertaintyValueType

Field ID: [09.321-J]

Condition: Optional within a field

Defined in: xsd/niem/biometrics/1.0/biometrics.xsd

Special Characters: n/a

Maximum Length: 3

Maximum Occurrences: 1

Regular Expression: n/a

Namespace: <http://niem.gov/niem/biometrics/1.0>

XPath

```
/it1:PackageMinutiaeRecord
├─/biom:ExtendedFeatureSetMinutiae
│  └─/biom:MinutiaeDelta
│     └─/biom:MinutiaeDeltaDirectionRightUncertaintyValue
```

Summary

Uncertainty of the right delta angle ("0" = indicates certain direction; "180" = unknown orientation).

Valid Examples

```
<biom:MinutiaeDeltaDirectionRightUncertaintyValue>180</biom:MinutiaeDeltaDirectionRightUncertaintyValue>
```

*The code table is optional, defining commonly-used or special-purpose values, rather than definitive (listing all possible values).

10.111. EFS Core-Delta Ridge Counts - CDR

Field Reference: 9/CDR	Field ID: [09.322]
Content Type: Set	Condition: Dependent (see table)
XML Tag Name: MinutiaeRidgeCountCoreToDelta	Defined in: xsd/niem/biometrics/1.0/biometrics.xsd
Data Type:	Special Characters: <i>n/a</i>
Minimum Length:	Maximum Length:
Minimum Occurrences: 0	Maximum Occurrences: 255
Value range: <i>n/a</i>	Regular Expression: <i>n/a</i>
Code table: <i>n/a</i>	
Base type: biom:MinutiaeRidgeCountCoreToDeltaType	Namespace: http://niem.gov/niem/biometrics/1.0

Dependency table

Type of dependency	Value
Optional on Presence of other Field	9/ROI

XPath

```
/it1:PackageMinutiaeRecord
  ↳/biom:ExtendedFeatureSetMinutiae
    ↳/biom:MinutiaeRidgeCountCoreToDelta
```

Summary

Count of ridges between each EFS core and delta.

Notes

If the exact value is known, then that value should be put in the minimum and maximum fields. If only a minimum is known, such as when a delta is not visible, the maximum value shall be omitted. If there are more than two cores and deltas, only the leftmost and rightmost of the cores and deltas need to be used for ridge counts.

10.112. Core Index - CIX

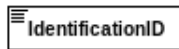

Field Reference: 9/CDR/CIX
Content Type: Data
XML Tag Name: IdentificationID
Data Type: AN
Minimum Length: 1
Minimum Occurrences: 1
Value range: {1..99,"L","U"}
Code table: *n/a*
Base type: niem-xsd:string

Field ID: [09.322-A]
Condition: Mandatory within a field
Defined in: xsd/niem/niem-core/2.0/niem-core.xsd
Special Characters: *n/a*
Maximum Length: 2
Maximum Occurrences: 1
Regular Expression: *n/a*

Namespace: <http://niem.gov/niem/niem-core/2.0>

XPath

```

/itl:PackageMinutiaeRecord
  ↳/biom:ExtendedFeatureSetMinutiae
    ↳/biom:MinutiaeRidgeCountCoreToDelta
      ↳/biom:MinutiaeCoreIdentification
        ↳/nc:IdentificationID
  
```

Summary

Identifier of core corresponding to this count ("1" if only one core is defined). If the relevant core is not defined, this shall be set to "U" to indicate an upper core or "L" to indicate a lower core (whorls only), permitting minimum ridge counts when cores are not in the region of interest.

Valid Examples

```
<nc:IdentificationID>L</nc:IdentificationID>
```

10.113. Delta index - DIX

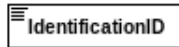

Field Reference: 9/CDR/DIX
Content Type: Data
XML Tag Name: IdentificationID
Data Type: AN
Minimum Length: 1
Minimum Occurrences: 1
Value range: {1..99,"L","R"}
Code table: *n/a*
Base type: niem-xsd:string

Field ID: [09.322-B]
Condition: Mandatory within a field
Defined in: xsd/niem/niem-core/2.0/niem-core.xsd
Special Characters: *n/a*
Maximum Length: 2
Maximum Occurrences: 1
Regular Expression: *n/a*

Namespace: <http://niem.gov/niem/niem-core/2.0>

XPath

```

/itl:PackageMinutiaeRecord
  ↳/biom:ExtendedFeatureSetMinutiae
    ↳/biom:MinutiaeRidgeCountCoreToDelta
      ↳/biom:MinutiaeDeltaIdentification
        ↳/nc:IdentificationID
  
```

Summary

Identifier of delta corresponding to this count ("1" if only one delta is defined). If the relevant delta is not defined, this shall be set to "L" to indicate a left delta or "R" to indicate a right delta, permitting minimum ridge counts when deltas are not in the region of interest.

Valid Examples

```
<nc:IdentificationID>L</nc:IdentificationID>
```

10.114. Min Ridge Count - MNRC

Field Reference: 9/CDR/MNRC

Content Type: Data

XML Tag Name: RidgeCountMinimumValue

Data Type: N

Minimum Length: 1

Minimum Occurrences: 1

Value range: {1..99}

Code table: *n/a*

Base type: niem-xsd:nonNegativeInteger

Field ID: [09.322-C]

Condition: Mandatory within a field

Defined in: xsd/niem/biometrics/1.0/biometrics.xsd

Special Characters: *n/a*

Maximum Length: 2

Maximum Occurrences: 1

Regular Expression: *n/a*

Namespace: <http://niem.gov/niem/biometrics/1.0>

XPath

```
/it1:PackageMinutiaeRecord  
  ↳/biom:ExtendedFeatureSetMinutiae  
    ↳/biom:MinutiaeRidgeCountCoreToDelta  
      ↳/biom:RidgeCountMinimumValue
```

Summary

Precise ridge count if known; otherwise minimum of range of ridge count values.

Valid Examples

```
<biom:RidgeCountMinimumValue>45</biom:RidgeCountMinimumValue>
```

10.115. Max Ridge Count - MXRC

Field Reference: 9/CDR/MXRC

Content Type: Data

XML Tag Name: RidgeCountMaximumValue

Data Type: N

Minimum Length: 1

Minimum Occurrences: 0

Value range: {1..99}

Code table: *n/a*

Base type: niem-xsd:nonNegativeInteger

Field ID: [09.322-D]

Condition: Optional within a field

Defined in: xsd/niem/biometrics/1.0/biometrics.xsd

Special Characters: *n/a*

Maximum Length: 2

Maximum Occurrences: 1

Regular Expression: *n/a*

Namespace: <http://niem.gov/niem/biometrics/1.0>

XPath

```
/it1:PackageMinutiaeRecord  
  ↳/biom:ExtendedFeatureSetMinutiae  
    ↳/biom:MinutiaeRidgeCountCoreToDelta  
      ↳/biom:RidgeCountMaximumValue
```

Summary

Precise ridge count if known; otherwise, maximum of range of ridge count values (if there is a known or estimated maximum). If maximum is not known, this information item shall be omitted.

Valid Examples

```
<biom:RidgeCountMaximumValue>45</biom:RidgeCountMaximumValue>
```

10.116. EFS Center Point of Reference - CPR

Field Reference: 9/CPR	Field ID: [09.323]
Content Type: Set	Condition: Dependent (see table)
XML Tag Name: FrictionRidgeImageCenter	Defined in: xsd/niem/biometrics/1.0/biometrics.xsd
Data Type:	Special Characters: <i>n/a</i>
Minimum Length:	Maximum Length:
Minimum Occurrences: 0	Maximum Occurrences: 3
Value range: <i>n/a</i>	Regular Expression: <i>n/a</i>
Code table: <i>n/a</i>	
Base type: biom:FrictionRidgeImageCenterType	Namespace: http://niem.gov/niem/biometrics/1.0

Dependency table

Type of dependency	Value
Optional on Presence of other Field	9/ROI

XPath

```
/it1:PackageMinutiaeRecord
  ↙/biom:ExtendedFeatureSetMinutiae
    ↙/biom:FrictionRidgeImageCenter
```

Summary

Location of a center point of reference of a fingerprint, which may be used to define how centered a fingerprint is, as a feature, for registration or orientation, and for quality measurements. While the core may serve some of the same purposes, a center point of reference is defined for arches and provides a single center location for complex whorls, unlike cores.

Notes

The center point of reference is the sole EFS feature that can be located outside of the EFS region of interest. Note that this means that the X and Y values for CPR are the only EFS coordinates that may be negative, or greater than the ROI width or height.

10.117. Method - CPM

Field Reference: 9/CPR/CPM	Field ID: [09.323-A]
Content Type: Data	Condition: Mandatory within a field
XML Tag Name: FrictionRidgeImageCenterLocationMethod-Code	Defined in: xsd/niem/biometrics/1.0/biometrics.xsd
Data Type: AN	Special Characters: <i>n/a</i>
Minimum Length: 1	Maximum Length: 1
Minimum Occurrences: 1	Maximum Occurrences: 1
Value range: <i>n/a</i>	Regular Expression: <i>n/a</i>
Code table: see table A.11	
Base type: biom:FrictionRidgeImageCenterLocationMethodCodeType	Namespace: http://niem.gov/niem/biometrics/1.0

XPath

```

/it1:PackageMinutiaeRecord
  ↳/biom:ExtendedFeatureSetMinutiae
    ↳/biom:FrictionRidgeImageCenter
      ↳/biom:FrictionRidgeImageCenterLocationMethodCode
    
```

Summary

Method of determining the location of the center point of reference.

Valid Examples

```
<biom:FrictionRidgeImageCenterLocationMethodCode>H</biom:FrictionRidgeImageCenterLocationMethodCode>
```

10.118. X Coordinate - PXC

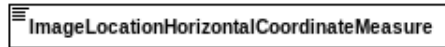

Field Reference: 9/CPR/PXC

Content Type: Data

XML Tag Name: ImageLocationHorizontalCoordinateMeasure

Data Type: NS

Minimum Length: 1

Minimum Occurrences: 1

Value range: {<=50000}

Code table: *n/a*

Base type: niem-xsd:integer

Field ID: [09.323-B]

Condition: Mandatory within a field

Defined in: xsd/niem/biometrics/1.0/biometrics.xsd

Special Characters: *n/a*

Maximum Length: 5

Maximum Occurrences: 1

Regular Expression: *n/a*

Namespace: <http://niem.gov/niem/biometrics/1.0>

XPath

```
/itl:PackageMinutiaeRecord
  ↳/biom:ExtendedFeatureSetMinutiae
    ↳/biom:FrictionRidgeImageCenter
      ↳/biom:ImageLocationHorizontalCoordinateMeasure
```

Summary

X coordinate of center point of reference (units of 10 micrometers).

Valid Examples

```
<biom:ImageLocationHorizontalCoordinateMeasure>1500</biom:ImageLocationHorizontalCoordinateMeasure>
```

10.119. Y Coordinate - PYC

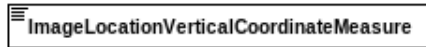

Field Reference: 9/CPR/PYC

Content Type: Data

XML Tag Name: ImageLocationVerticalCoordinateMeasure

Data Type: NS

Minimum Length: 1

Minimum Occurrences: 1

Value range: {<=50000}

Code table: *n/a*

Base type: niem-xsd:integer

Field ID: [09.323-C]

Condition: Mandatory within a field

Defined in: xsd/niem/biometrics/1.0/biometrics.xsd

Special Characters: *n/a*

Maximum Length: 5

Maximum Occurrences: 1

Regular Expression: *n/a*

Namespace: <http://niem.gov/niem/biometrics/1.0>

XPath

```
/itl:PackageMinutiaeRecord
  ↳/biom:ExtendedFeatureSetMinutiae
    ↳/biom:FrictionRidgeImageCenter
      ↳/biom:ImageLocationVerticalCoordinateMeasure
```

Summary

Y coordinate of center point of reference (units of 10 micrometers).

Valid Examples

```
<biom:ImageLocationVerticalCoordinateMeasure>1500</biom:ImageLocationVerticalCoordinateMeasure>
```

10.120. Radius of Position Uncertainty - CRU

Field Reference: 9/CPR/CRU

Content Type: Data

XML Tag Name: ImageLocationUncertaintyRadiusMeasure

Data Type: N

Minimum Length: 1

Minimum Occurrences: 0

Value range: {0..999}

Code table: *n/a*

Base type: niem-xsd:nonNegativeInteger

Field ID: [09.323-D]

Condition: Optional within a field

Defined in: xsd/niem/biometrics/1.0/biometrics.xsd

Special Characters: *n/a*

Maximum Length: 3

Maximum Occurrences: 1

Regular Expression: *n/a*

Namespace: <http://niem.gov/niem/biometrics/1.0>

XPath

```
/it1:PackageMinutiaeRecord
  ↳/biom:ExtendedFeatureSetMinutiae
    ↳/biom:FrictionRidgeImageCenter
      ↳/biom:ImageLocationUncertaintyRadiusMeasure
```

Summary

Radius of position uncertainty for center point of reference. The radius of position uncertainty is 0 (default) if the location is known precisely; otherwise the position is marked at the best estimate of position, with a radius including the area of other possible locations, in integer units of 10 micrometers.

Valid Examples

```
<biom:ImageLocationUncertaintyRadiusMeasure>502</biom:ImageLocationUncertaintyRadiusMeasure>
```

10.121. EFS Distinctive Features (XML) - DIS

Field Reference: 9/DIS:X	Field ID: [09.324:X]
Content Type: Set_X	Condition: Dependent (see table)
XML Tag Name: MinutiaeDistinctiveFeature	Defined in: xsd/niem/biometrics/1.0/biometrics.xsd
Data Type:	Special Characters: n/a
Minimum Length:	Maximum Length:
Minimum Occurrences: 0	Maximum Occurrences: 99
Value range: n/a	Regular Expression: n/a
Code table: n/a	
Base type: biom:MinutiaeDistinctiveFeatureType	Namespace: http://niem.gov/niem/biometrics/1.0

Dependency table

Type of dependency	Value
Mandatory on Absence of other Field	9/NDIS:X

XPath

```
/it1:PackageMinutiaeRecord
  ↙/biom:ExtendedFeatureSetMinutiae
    ↙/biom:MinutiaeDistinctiveFeature
```

Summary

Defines one or more areas containing unusually discriminating EFS features that are not defined anywhere else. The characteristics noted in this field are specific to the friction skin itself, as opposed to issues specific to the impression (such as smudging) that are noted in Field 9.357.

10.122. Distinctive Feature Type - DIT

Field Reference: 9/DIS/DIT	Field ID: [09.324-A]
Content Type: Data	Condition: Mandatory within a field
XML Tag Name: MinutiaeDistinctiveFeatureCategoryCode	Defined in: xsd/niem/biometrics/1.0/biometrics.xsd
Data Type: A	Special Characters: <i>n/a</i>
Minimum Length: 4	Maximum Length: 9
Minimum Occurrences: 1	Maximum Occurrences: 1
Value range: <i>n/a</i>	Regular Expression: <i>n/a</i>
Code table: see table A.16	
Base type: biom:MinutiaeDistinctiveFeatureCategoryCodeType	Namespace: http://niem.gov/niem/biometrics/1.0

XPath

```
/it1:PackageMinutiaeRecord  
  ↳/biom:ExtendedFeatureSetMinutiae  
    ↳/biom:MinutiaeDistinctiveFeature  
      ↳/biom:MinutiaeDistinctiveFeatureCategoryCode
```

Summary

Feature type.

Valid Examples

```
<biom:MinutiaeDistinctiveFeatureCategoryCode>DYSPLASIA</biom:MinutiaeDistinctiveFeatureCategoryCode>
```

10.123. Distinctive Features Polygon (XML) - DFP

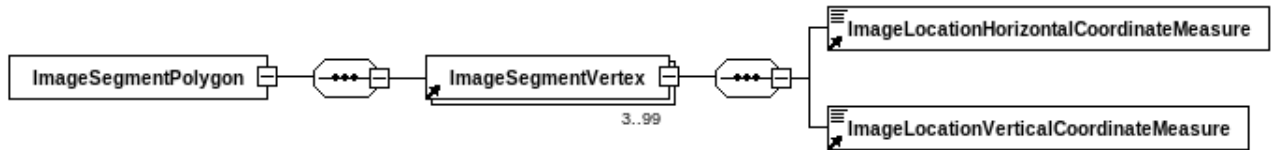

Field Reference: 9/DIS/DFP:X1
Content Type: Set_X
XML Tag Name: ImageSegmentPolygon
Data Type:
Minimum Length:
Minimum Occurrences: 0
Value range: *n/a*
Code table: *n/a*
Base type: biom:ImageSegmentPolygonType

Field ID: [09.324-B:X1]
Condition: Optional within a field
Defined in: xsd/niem/biometrics/1.0/biometrics.xsd
Special Characters: *n/a*
Maximum Length:
Maximum Occurrences: 1
Regular Expression: *n/a*
Namespace: <http://niem.gov/niem/biometrics/1.0>

XPath

```

/itl:PackageMinutiaeRecord
  ↙/biom:ExtendedFeatureSetMinutiae
    ↙/biom:MinutiaeDistinctiveFeature
      ↙/biom:ImageSegmentPolygon
    
```

Summary

Closed path polygon that outlines the area of the distinctive feature.

10.124. Image Segment Vertex (XML) - DFP

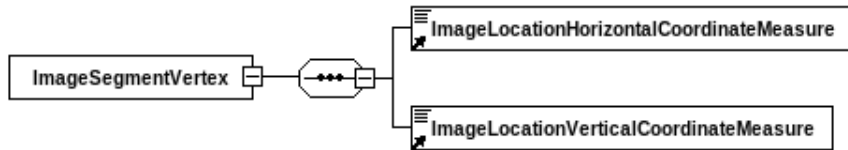

Field Reference: 9/DIS/DFP:X2
Content Type: Set_X
XML Tag Name: ImageSegmentVertex
Data Type:
Minimum Length:
Minimum Occurrences: 3
Value range: *n/a*
Code table: *n/a*
Base type: biom:ImageSegmentVertexType

Field ID: [09.324-B:X2]
Condition: Mandatory within a field
Defined in: xsd/niem/biometrics/1.0/biometrics.xsd
Special Characters: *n/a*
Maximum Length:
Maximum Occurrences: 99
Regular Expression: *n/a*
Namespace: <http://niem.gov/niem/biometrics/1.0>

XPath

```
/itl:PackageMinutiaeRecord
  ↳/biom:ExtendedFeatureSetMinutiae
    ↳/biom:MinutiaeDistinctiveFeature
      ↳/biom:ImageSegmentPolygon
        ↳/biom:ImageSegmentVertex
```

Summary

Closed path polygon that outlines the area of the distinctive feature.

10.125. Image Location Horizontal Coordinate Measure (XML) - DFP

ImageLocationHorizontalCoordinateMeasure

Field Reference: 9/DIS/DFP:X3

Content Type: Data_NX-1T

XML Tag Name: ImageLocationHorizontalCoordinateMeasure

Data Type: N

Minimum Length: 1

Minimum Occurrences: 1

Value range: {0..49999}

Code table: *n/a*

Base type: niem-xsd:integer

Field ID: [09.324-B:X3]

Condition: Mandatory within a field

Defined in: xsd/niem/biometrics/1.0/biometrics.xsd

Special Characters: *n/a*

Maximum Length: 5

Maximum Occurrences: 1

Regular Expression: *n/a*

Namespace: <http://niem.gov/niem/biometrics/1.0>

XPath

```
/itl:PackageMinutiaeRecord
├─ /biom:ExtendedFeatureSetMinutiae
│   └─ /biom:MinutiaeDistinctiveFeature
│       └─ /biom:ImageSegmentPolygon
│           └─ /biom:ImageSegmentVertex
│               └─ /biom:ImageLocationHorizontalCoordinateMeasure
```

Summary

Closed path polygon that outlines the area of the distinctive feature.

Valid Examples

```
<biom:ImageLocationHorizontalCoordinateMeasure>2510</biom:ImageLocationHorizontalCoordinateMeasure>
```

10.126. Image Location Vertical Coordinate Measure (XML) - DFP

 ImageLocationVerticalCoordinateMeasure

Field Reference: 9/DIS/DFP:X4

Content Type: Data_NX-1T

XML Tag Name: ImageLocationVerticalCoordinateMeasure

Data Type: N

Minimum Length: 1

Minimum Occurrences: 1

Value range: {0..49999}

Code table: *n/a*

Base type: niem-xsd:integer

Field ID: [09.324-B:X4]

Condition: Mandatory within a field

Defined in: xsd/niem/biometrics/1.0/biometrics.xsd

Special Characters: *n/a*

Maximum Length: 5

Maximum Occurrences: 1

Regular Expression: *n/a*

Namespace: <http://niem.gov/niem/biometrics/1.0>

XPath

```
/itl:PackageMinutiaeRecord
├─/biom:ExtendedFeatureSetMinutiae
│   └─/biom:MinutiaeDistinctiveFeature
│       └─/biom:ImageSegmentPolygon
│           └─/biom:ImageSegmentVertex
│               └─/biom:ImageLocationVerticalCoordinateMeasure
```

Summary

Closed path polygon that outlines the area of the distinctive feature.

Valid Examples

```
<biom:ImageLocationVerticalCoordinateMeasure>1290</biom:ImageLocationVerticalCoordinateMeasure>
```

10.127. Distinctive Features Comment - DFC

Field Reference: 9/DIS/DFC

Content Type: Data

XML Tag Name: MinutiaeCommentText

Data Type: U

Minimum Length: 1

Minimum Occurrences: 0

Value range: *n/a*

Code table: *n/a*

Base type: nc:TextType

Field ID: [09.324-C]

Condition: Optional within a field

Defined in: xsd/niem/biometrics/1.0/biometrics.xsd

Special Characters: *n/a*

Maximum Length: 1000

Maximum Occurrences: 1

Regular Expression: *n/a*

Namespace: <http://niem.gov/niem/biometrics/1.0>

XPath

```
/it1:PackageMinutiaeRecord
  ↳/biom:ExtendedFeatureSetMinutiae
    ↳/biom:MinutiaeDistinctiveFeature
      ↳/biom:MinutiaeCommentText
```

Summary

Optional text describing the feature.

10.128. EFS No Cores Present (XML) - NCOR

Field Reference: 9/NCOR:X	Field ID: [09.325:X]
Content Type: Data_X	Condition: Dependent (see table)
XML Tag Name: MinutiaeNoCoresPresentIndicator	Defined in: xsd/niem/biometrics/1.0/biometrics.xsd
Data Type: Y	Special Characters: <i>n/a</i>
Minimum Length: 1	Maximum Length: 4
Minimum Occurrences: 0	Maximum Occurrences: 1
Value range: {"true",1}	Regular Expression: <i>n/a</i>
Code table: <i>n/a</i>	
Base type: niem-xsd:boolean	Namespace: http://niem.gov/niem/biometrics/1.0

Dependency table

Type of dependency	Value
Mandatory on Absence of other Field	9/COR:X

XPath

```
/it1:PackageMinutiaeRecord
  ↳/biom:ExtendedFeatureSetMinutiae
    ↳/biom:MinutiaeNoCoresPresentIndicator
```

Summary

Indicates if no EFS cores can be discerned.

Notes

Omit field if false

Valid Examples

```
<biom:MinutiaeNoCoresPresentIndicator>true</biom:MinutiaeNoCoresPresentIndicator>
```

10.129. EFS No Deltas Present (XML) - NDEL

Field Reference: 9/NDEL:X	Field ID: [09.326:X]
Content Type: Data_X	Condition: Dependent (see table)
XML Tag Name: MinutiaeNoDeltasPresentIndicator	Defined in: xsd/niem/biometrics/1.0/biometrics.xsd
Data Type: Y	Special Characters: <i>n/a</i>
Minimum Length: 1	Maximum Length: 4
Minimum Occurrences: 0	Maximum Occurrences: 1
Value range: {"true",1}	Regular Expression: <i>n/a</i>
Code table: <i>n/a</i>	
Base type: niem-xsd:boolean	Namespace: http://niem.gov/niem/biometrics/1.0

Dependency table

Type of dependency	Value
Mandatory on Absence of other Field	9/DEL:X

XPath

```
/it1:PackageMinutiaeRecord
  ↳/biom:ExtendedFeatureSetMinutiae
    ↳/biom:MinutiaeNoDeltasPresentIndicator
```

Summary

Indicates if no EFS deltas can be discerned.

Notes

Omit field if false

Valid Examples

```
<biom:MinutiaeNoDeltasPresentIndicator>true</biom:MinutiaeNoDeltasPresentIndicator>
```

10.130. EFS No Distinctive Features Present (XML) - NDIS

Field Reference: 9/NDIS:X	Field ID: [09.327:X]
Content Type: Data_X	Condition: Dependent (see table)
XML Tag Name: MinutiaeNoDistinctiveFeaturesPresentIndicator	Defined in: xsd/niem/biometrics/1.0/biometrics.xsd
Data Type: Y	Special Characters: <i>n/a</i>
Minimum Length: 1	Maximum Length: 4
Minimum Occurrences: 0	Maximum Occurrences: 1
Value range: {"true",1}	Regular Expression: <i>n/a</i>
Code table: <i>n/a</i>	
Base type: niem-xsd:boolean	Namespace: http://niem.gov/niem/biometrics/1.0

Dependency table

Type of dependency	Value
Mandatory on Absence of other Field	9/DIS:X

XPath

```
/it1:PackageMinutiaeRecord
  ↳/biom:ExtendedFeatureSetMinutiae
    ↳/biom:MinutiaeNoDistinctiveFeaturesPresentIndicator
```

Summary

Indicates if no EFS distinctive features can be discerned.

Notes

Omit field if false

Valid Examples

```
<biom:MinutiaeNoDistinctiveFeaturesPresentIndicator>true</biom:MinutiaeNoDistinctiveFeaturesPresentIndicator>
```

10.131. EFS Minutiae (XML) - MIN

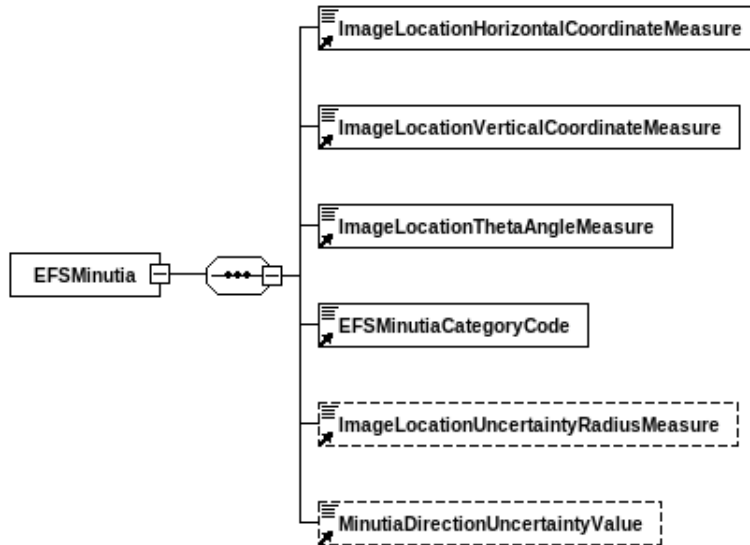

Field Reference: 9/MIN:X
Content Type: Set_X
XML Tag Name: EFSMinutia
Data Type:
Minimum Length:
Minimum Occurrences: 0
Value range: *n/a*
Code table: *n/a*
Base type: biom:EFSMinutiaType

Field ID: [09.331:X]
Condition: Dependent (see table)
Defined in: xsd/niem/biometrics/1.0/biometrics.xsd
Special Characters: *n/a*
Maximum Length:
Maximum Occurrences: 9999
Regular Expression: *n/a*
Namespace: <http://niem.gov/niem/biometrics/1.0>

Dependency table

Type of dependency	Value
Mandatory on Absence of other Field	9/NMIN:X

XPath

```

/itl:PackageMinutiaeRecord
  ↳/biom:ExtendedFeatureSetMinutiae
    ↳/biom:EFSMinutia
    
```

Summary

Characteristics of all EFS minutiae in the region of interest.

Notes

ANSI/NIST umbrella standard limits the number of minutiae to 999. Large palm marks (and enrolled palm) can exceed 999 minutiae; INT-I increases this limits to 9999.

10.132. X Coordinate - MXC

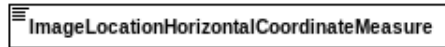

Field Reference: 9/MIN/MXC

Content Type: Data

XML Tag Name: ImageLocationHorizontalCoordinateMeasure

Data Type: N

Minimum Length: 1

Minimum Occurrences: 1

Value range: *n/a*

Code table: *n/a*

Base type: niem-xsd:integer

Field ID: [09.331-A]

Condition: Mandatory within a field

Defined in: xsd/niem/biometrics/1.0/biometrics.xsd

Special Characters: *n/a*

Maximum Length: 5

Maximum Occurrences: 1

Regular Expression: *n/a*

Namespace: <http://niem.gov/niem/biometrics/1.0>

XPath

```
/itl:PackageMinutiaeRecord
  ↳/biom:ExtendedFeatureSetMinutiae
    ↳/biom:EFSSMinutia
      ↳/biom:ImageLocationHorizontalCoordinateMeasure
```

Summary

X coordinate of minutia (units of 10 micrometers).

Valid Examples

```
<biom:ImageLocationHorizontalCoordinateMeasure>2500</biom:ImageLocationHorizontalCoordinateMeasure>
```

10.133. Y Coordinate - MYC

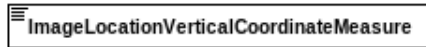

Field Reference: 9/MIN/MYC

Content Type: Data

XML Tag Name: ImageLocationVerticalCoordinateMeasure

Data Type: N

Minimum Length: 1

Minimum Occurrences: 1

Value range: *n/a*

Code table: *n/a*

Base type: niem-xsd:integer

Field ID: [09.331-B]

Condition: Mandatory within a field

Defined in: xsd/niem/biometrics/1.0/biometrics.xsd

Special Characters: *n/a*

Maximum Length: 5

Maximum Occurrences: 1

Regular Expression: *n/a*

Namespace: <http://niem.gov/niem/biometrics/1.0>

XPath

```
/itl:PackageMinutiaeRecord
  ↳/biom:ExtendedFeatureSetMinutiae
    ↳/biom:EFSMinutia
      ↳/biom:ImageLocationVerticalCoordinateMeasure
```

Summary

Y coordinate of minutia (units of 10 micrometers).

Valid Examples

```
<biom:ImageLocationVerticalCoordinateMeasure>2500</biom:ImageLocationVerticalCoordinateMeasure>
```

10.134. Theta Degrees - MTD

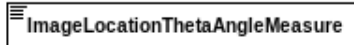

Field Reference: 9/MIN/MTD

Content Type: Data

XML Tag Name: ImageLocationThetaAngleMeasure

Data Type: N

Minimum Length: 1

Minimum Occurrences: 1

Value range: {1..180}

Code table: see table [A.2](#) *

Base type: biom:ThetaAngleMeasureType

Field ID: [09.331-C]

Condition: Mandatory within a field

Defined in: xsd/niem/biometrics/1.0/biometrics.xsd

Special Characters: *n/a*

Maximum Length: 3

Maximum Occurrences: 1

Regular Expression: *n/a*

Namespace: <http://niem.gov/niem/biometrics/1.0>

XPath

```
/itl:PackageMinutiaeRecord
  ↳/biom:ExtendedFeatureSetMinutiae
    ↳/biom:EFSMinutia
      ↳/biom:ImageLocationThetaAngleMeasure
```

Summary

Direction (angle) of minutia.

Valid Examples

```
<biom:ImageLocationThetaAngleMeasure>101</biom:ImageLocationThetaAngleMeasure>
```

*The code table is optional, defining commonly-used or special-purpose values, rather than definitive (listing all possible values).

10.135. Minutia Type - MTY

 EFSMinutiaCategoryCode
--

Field Reference: 9/MIN/MTY
Content Type: Data
XML Tag Name: EFSMinutiaCategoryCode
Data Type: A
Minimum Length: 1
Minimum Occurrences: 1
Value range: *n/a*
Code table: see table [A.37](#)
Base type: biom:EFSMinutiaCategoryCodeType

Field ID: [09.331-D]
Condition: Mandatory within a field
Defined in: xsd/niem/biometrics/1.0/biometrics.xsd
Special Characters: *n/a*
Maximum Length: 1
Maximum Occurrences: 1
Regular Expression: *n/a*
Namespace: <http://niem.gov/niem/biometrics/1.0>

XPath

```
/it1:PackageMinutiaeRecord  
  ↙/biom:ExtendedFeatureSetMinutiae  
    ↙/biom:EFSMinutia  
      ↙/biom:EFSMinutiaCategoryCode
```

Summary

Type of minutia.

Valid Examples

<code><biom:EFSMinutiaCategoryCode>E</biom:EFSMinutiaCategoryCode></code>

10.136. Radius of Position Uncertainty - MRU

Field Reference: 9/MIN/MRU

Content Type: Data

XML Tag Name: ImageLocationUncertaintyRadiusMeasure

Data Type: N

Minimum Length: 1

Minimum Occurrences: 0

Value range: {0..999}

Code table: *n/a*

Base type: niem-xsd:nonNegativeInteger

Field ID: [09.331-E]

Condition: Optional within a field

Defined in: xsd/niem/biometrics/1.0/biometrics.xsd

Special Characters: *n/a*

Maximum Length: 3

Maximum Occurrences: 1

Regular Expression: *n/a*

Namespace: <http://niem.gov/niem/biometrics/1.0>

Dependency table

Type of dependency	Value
Mandatory on Value of other Field, optional otherwise.	[9/MIN/MTY]="X"

XPath

```
/it1:PackageMinutiaeRecord
  ↳/biom:ExtendedFeatureSetMinutiae
    ↳/biom:EFSSMinutia
      ↳/biom:ImageLocationUncertaintyRadiusMeasure
```

Summary

Radius of a circle defining the location (X,Y) of the minutia.

Valid Examples

```
<biom:ImageLocationUncertaintyRadiusMeasure>120</biom:ImageLocationUncertaintyRadiusMeasure>
```

10.137. Minutiae Direction of Uncertainty - MDU

Field Reference: 9/MIN/MDU

Content Type: Data

XML Tag Name: MinutiaDirectionUncertaintyValue

Data Type: N

Minimum Length: 1

Minimum Occurrences: 0

Value range: {0..180}

Code table: see table [A.2](#) *

Base type: biom:UncertaintyValueType

Field ID: [09.331-F]

Condition: Optional within a field

Defined in: xsd/niem/biometrics/1.0/biometrics.xsd

Special Characters: *n/a*

Maximum Length: 3

Maximum Occurrences: 1

Regular Expression: *n/a*

Namespace: <http://niem.gov/niem/biometrics/1.0>

XPath

```
/it1:PackageMinutiaeRecord  
  ↳/biom:ExtendedFeatureSetMinutiae  
    ↳/biom:EFSMinutia  
      ↳/biom:MinutiaDirectionUncertaintyValue
```

Summary

Direction uncertainty of minutia.

Valid Examples

```
<biom:MinutiaDirectionUncertaintyValue>120</biom:MinutiaDirectionUncertaintyValue>
```

*The code table is optional, defining commonly-used or special-purpose values, rather than definitive (listing all possible values).

10.138. EFS Minutiae Ridge Count Algorithm - MRA

Field Reference: 9/MRA	Field ID: [09.332]
Content Type: Data	Condition: Dependent (see table)
XML Tag Name: EFSRidgeCountAlgorithmCode	Defined in: xsd/niem/biometrics/1.0/biometrics.xsd
Data Type: AN	Special Characters: <i>n/a</i>
Minimum Length: 5	Maximum Length: 8
Minimum Occurrences: 0	Maximum Occurrences: 1
Value range: <i>n/a</i>	Regular Expression: <i>n/a</i>
Code table: see table A.38	
Base type: biom:EFSRidgeCountAlgorithmCodeType	Namespace: http://niem.gov/niem/biometrics/1.0

Dependency table

Type of dependency	Value
Optional on Presence of other Field	9/MRC
Mandatory on Value of other Field, optional otherwise.	[9/FSP]=11

XPath

```
/it1:PackageMinutiaeRecord
  ↳/biom:ExtendedFeatureSetMinutiae
    ↳/biom:EFSRidgeCountAlgorithmCode
```

Summary

Algorithm used in determining how neighboring minutiae are selected for use in the ridge counts in Field 9.333.

Valid Examples

```
<biom:EFSRidgeCountAlgorithmCode>EFTS7</biom:EFSRidgeCountAlgorithmCode>
```

10.139. EFS Minutiae Ridge Counts - MRC

Field Reference: 9/MRC

Content Type: Set

XML Tag Name: EFSRidgeCountItem

Data Type:

Minimum Length:

Minimum Occurrences: 0

Value range: *n/a*

Code table: *n/a*

Base type: biom:EFSRidgeCountItemType

Field ID: [09.333]

Condition: Dependent (see table)

Defined in: xsd/niem/biometrics/1.0/biometrics.xsd

Special Characters: *n/a*

Maximum Length:

Maximum Occurrences: 7992

Regular Expression: *n/a*

Namespace: <http://niem.gov/niem/biometrics/1.0>

Dependency table

Type of dependency	Value
Optional on Presence of other Field	9/ROI
Mandatory on Value of other Field, optional otherwise.	[9/FSP]=11

XPath

```
/it1:PackageMinutiaeRecord
  ↙/biom:ExtendedFeatureSetMinutiae
    ↙/biom:EFSRidgeCountItem
```

Summary

EFS ridge counts between specified minutiae.

10.140. Minutia Index A - MIA



Field Reference: 9/MRC/MIA
Content Type: Data
XML Tag Name: IdentificationID
Data Type: N
Minimum Length: 1
Minimum Occurrences: 1
Value range: {1..9999}
Code table: *n/a*
Base type: niem-xsd:string

Field ID: [09.333-A]
Condition: Mandatory within a field
Defined in: xsd/niem/niem-core/2.0/niem-core.xsd
Special Characters: *n/a*
Maximum Length: 4
Maximum Occurrences: 1
Regular Expression: *n/a*

Namespace: <http://niem.gov/niem/niem-core/2.0>

XPath

```
/itl:PackageMinutiaeRecord  
  ↳/biom:ExtendedFeatureSetMinutiae  
    ↳/biom:EFSRidgeCountItem  
      ↳/biom:MinutiaIdentification  
        ↳/nc:IdentificationID
```

Summary

Index of first minutia.

Valid Examples

```
<nc:IdentificationID>190</nc:IdentificationID>
```

10.141. Minutia Index B - MIB



Field Reference: 9/MRC/MIB
Content Type: Data
XML Tag Name: IdentificationID
Data Type: N
Minimum Length: 1
Minimum Occurrences: 1
Value range: {1..9999}
Code table: *n/a*
Base type: niem-xsd:string

Field ID: [09.333-B]
Condition: Mandatory within a field
Defined in: xsd/niem/niem-core/2.0/niem-core.xsd
Special Characters: *n/a*
Maximum Length: 4
Maximum Occurrences: 1
Regular Expression: *n/a*

Namespace: <http://niem.gov/niem/niem-core/2.0>

XPath

```
/itl:PackageMinutiaeRecord  
  ↳/biom:ExtendedFeatureSetMinutiae  
    ↳/biom:EFSRidgeCountItem  
      ↳/biom:MinutiaReferenceIdentification  
        ↳/nc:IdentificationID
```

Summary

Index of second minutia.

Valid Examples

```
<nc:IdentificationID>90</nc:IdentificationID>
```

10.142. Ridge Count - MIR

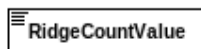

Field Reference: 9/MRC/MIR
Content Type: Data
XML Tag Name: RidgeCountValue
Data Type: N
Minimum Length: 1
Minimum Occurrences: 1
Value range: {0..99}
Code table: *n/a*
Base type: niem-xsd:nonNegativeInteger

Field ID: [09.333-C]
Condition: Mandatory within a field
Defined in: xsd/niem/biometrics/1.0/biometrics.xsd
Special Characters: *n/a*
Maximum Length: 2
Maximum Occurrences: 1
Regular Expression: *n/a*

Namespace: <http://niem.gov/niem/biometrics/1.0>

XPath

```

/itl:PackageMinutiaeRecord
├─/biom:ExtendedFeatureSetMinutiae
│   └─/biom:EFSRidgeCountItem
│       └─/biom:RidgeCountValue
  
```

Summary

Ridge count between minutia A and B.

Valid Examples

```
<biom:RidgeCountValue>90</biom:RidgeCountValue>
```

10.143. Reference Number - MRN

Field Reference: 9/MRC/MRN

Content Type: Data

XML Tag Name: MinutiaeRidgeCountOctantNumeric

Data Type: N

Minimum Length: 1

Minimum Occurrences: 0

Value range: {1..8}

Code table: *n/a*

Base type: biom:OctantNumericType

Field ID: [09.333-D]

Condition: Optional within a field

Defined in: xsd/niem/biometrics/1.0/biometrics.xsd

Special Characters: *n/a*

Maximum Length: 1

Maximum Occurrences: 1

Regular Expression: *n/a*

Namespace: <http://niem.gov/niem/biometrics/1.0>

XPath

```
/itl:PackageMinutiaeRecord
  ↳/biom:ExtendedFeatureSetMinutiae
    ↳/biom:EFSRidgeCountItem
      ↳/biom:MinutiaeRidgeCountOctantNumeric
```

Summary

Reference number specific to the ridge count algorithm. For the OCTANT and EFTS7 ridge count algorithms, this information item specifies the octant. For the QUADRANT ridge count algorithm, this information item specifies the quadrant.

Valid Examples

```
<biom:MinutiaeRidgeCountOctantNumeric>1</biom:MinutiaeRidgeCountOctantNumeric>
```

10.144. Residual - MRS

Field Reference: 9/MRC/MRS

Content Type: Data

XML Tag Name: MinutiaeRidgeCountResidualCode

Data Type: N

Minimum Length: 1

Minimum Occurrences: 0

Value range: *n/a*

Code table: see table [A.39](#)

Base type: biom:MinutiaeRidgeCountResidualCodeType

Field ID: [09.333-E]

Condition: Optional within a field

Defined in: xsd/niem/biometrics/1.0/biometrics.xsd

Special Characters: *n/a*

Maximum Length: 1

Maximum Occurrences: 1

Regular Expression: *n/a*

Namespace: <http://niem.gov/niem/biometrics/1.0>

XPath

```

/itl:PackageMinutiaeRecord
├─/biom:ExtendedFeatureSetMinutiae
│   └─/biom:EFSRidgeCountItem
│       └─/biom:MinutiaeRidgeCountResidualCode

```

Summary

Specifies the half of the octant in which the neighboring minutia lies (for OCTANT and EFTS7 algorithms).

Valid Examples

```
<biom:MinutiaeRidgeCountResidualCode>1</biom:MinutiaeRidgeCountResidualCode>
```

10.145. EFS No Minutia Present (XML) - NMIN

Field Reference: 9/NMIN:X	Field ID: [09.334:X]
Content Type: Data_X	Condition: Dependent (see table)
XML Tag Name: MinutiaeNoMinutiaePresentIndicator	Defined in: xsd/niem/biometrics/1.0/biometrics.xsd
Data Type: Y	Special Characters: <i>n/a</i>
Minimum Length: 1	Maximum Length: 4
Minimum Occurrences: 0	Maximum Occurrences: 1
Value range: {"true",1}	Regular Expression: <i>n/a</i>
Code table: <i>n/a</i>	
Base type: niem-xsd:boolean	Namespace: http://niem.gov/niem/biometrics/1.0

Dependency table

Type of dependency	Value
Mandatory on Absence of other Field	9/MIN:X

XPath

```
/it1:PackageMinutiaeRecord
  ↙/biom:ExtendedFeatureSetMinutiae
    ↙/biom:MinutiaeNoMinutiaePresentIndicator
```

Summary

Indicates if no EFS minutiae can be discerned.

Notes

Omit field if false

Valid Examples

```
<biom:MinutiaeNoMinutiaePresentIndicator>true</biom:MinutiaeNoMinutiaePresentIndicator>
```

10.146. EFS Ridge Count Confidence - RCC

Field Reference: 9/RCC	Field ID: [09.335]
Content Type: Set	Condition: Dependent (see table)
XML Tag Name: MinutiaeRidgeCountConfidence	Defined in: xsd/niem/biometrics/1.0/biometrics.xsd
Data Type:	Special Characters: <i>n/a</i>
Minimum Length:	Maximum Length:
Minimum Occurrences: 0	Maximum Occurrences: 7992
Value range: <i>n/a</i>	Regular Expression: <i>n/a</i>
Code table: <i>n/a</i>	
Base type: biom:MinutiaeRidgeCountConfidenceType	Namespace: http://niem.gov/niem/biometrics/1.0

Dependency table

Type of dependency	Value
Optional on Presence of other Field	9/ROI

XPath

```

/it1:PackageMinutiaeRecord
└─/biom:ExtendedFeatureSetMinutiae
  └─/biom:MinutiaeRidgeCountConfidence
    
```

Summary

Confidence in intervening EFS ridge counts between two points (e.g., minutiae, core/delta). If this field is not used, the default assumption is that the ridge counts were manually determined.

10.147. Minutia Location Point (XML)

Field Reference: 9/RCC/ACX_9/RCC/ACY

Content Type: Set_X

XML Tag Name: MinutiaLocationPoint

Data Type:

Minimum Length:

Minimum Occurrences: 1

Value range: *n/a*

Code table: *n/a*

Base type: biom:ImageSegmentVertexType

Field ID: [09.335-A_09.335-B]

Condition: Mandatory within a field

Defined in: xsd/niem/biometrics/1.0/biometrics.xsd

Special Characters: *n/a*

Maximum Length:

Maximum Occurrences: 1

Regular Expression: *n/a*

Namespace: <http://niem.gov/niem/biometrics/1.0>

XPath

```
/it1:PackageMinutiaeRecord
  ↙/biom:ExtendedFeatureSetMinutiae
    ↙/biom:MinutiaeRidgeCountConfidence
      ↙/biom:MinutiaLocationPoint
```

Summary

Coordinates for point A (units of 10 micrometers).

Notes

Applies to 9.335-A and 9.335-B

10.148. X Coordinate Point A - ACX

 ImageLocationHorizontalCoordinateMeasure
--

Field Reference: 9/RCC/ACX

Content Type: Data

XML Tag Name: ImageLocationHorizontalCoordinateMeasure

Data Type: N

Minimum Length: 1

Minimum Occurrences: 1

Value range: *n/a*

Code table: *n/a*

Base type: niem-xsd:integer

Field ID: [09.335-A]

Condition: Mandatory within a field

Defined in: xsd/niem/biometrics/1.0/biometrics.xsd

Special Characters: *n/a*

Maximum Length: 5

Maximum Occurrences: 1

Regular Expression: *n/a*

Namespace: <http://niem.gov/niem/biometrics/1.0>

XPath

```
/itl:PackageMinutiaeRecord
  ↳/biom:ExtendedFeatureSetMinutiae
    ↳/biom:MinutiaeRidgeCountConfidence
      ↳/biom:MinutiaLocationPoint
        ↳/biom:ImageLocationHorizontalCoordinateMeasure
```

Summary

X coordinate for point A (units of 10 micrometers).

Valid Examples

<code><biom:ImageLocationHorizontalCoordinateMeasure>6422</biom:ImageLocationHorizontalCoordinateMeasure></code>
--

10.149. Y Coordinate Point A - ACY

 ImageLocationVerticalCoordinateMeasure

Field Reference: 9/RCC/ACY

Content Type: Data

XML Tag Name: ImageLocationVerticalCoordinateMeasure

Data Type: N

Minimum Length: 1

Minimum Occurrences: 1

Value range: *n/a*

Code table: *n/a*

Base type: niem-xsd:integer

Field ID: [09.335-B]

Condition: Mandatory within a field

Defined in: xsd/niem/biometrics/1.0/biometrics.xsd

Special Characters: *n/a*

Maximum Length: 5

Maximum Occurrences: 1

Regular Expression: *n/a*

Namespace: <http://niem.gov/niem/biometrics/1.0>

XPath

```
/itl:PackageMinutiaeRecord
  ↳/biom:ExtendedFeatureSetMinutiae
    ↳/biom:MinutiaeRidgeCountConfidence
      ↳/biom:MinutiaLocationPoint
        ↳/biom:ImageLocationVerticalCoordinateMeasure
```

Summary

Y coordinate for point A (units of 10 micrometers).

Valid Examples

```
<biom:ImageLocationVerticalCoordinateMeasure>6422</biom:ImageLocationVerticalCoordinateMeasure>
```

10.150. Minutia Location Reference Point (XML)

Field Reference: 9/RCC/BCX_9/RCC/BCY
Content Type: Set_X
XML Tag Name: MinutiaLocationReferencePoint
Data Type:
Minimum Length:
Minimum Occurrences: 1
Value range: *n/a*
Code table: *n/a*
Base type: biom:ImageSegmentVertexType

Field ID: [09.335-C_09.335-D]
Condition: Mandatory within a field
Defined in: xsd/niem/biometrics/1.0/biometrics.xsd
Special Characters: *n/a*
Maximum Length:
Maximum Occurrences: 1
Regular Expression: *n/a*
Namespace: <http://niem.gov/niem/biometrics/1.0>

XPath

```
/it1:PackageMinutiaeRecord  
  ↙/biom:ExtendedFeatureSetMinutiae  
    ↙/biom:MinutiaeRidgeCountConfidence  
      ↙/biom:MinutiaLocationReferencePoint
```

Summary

Coordinates for point B (units of 10 micrometers).

Notes

Applies to 9.335-C and 9.335-D

10.151. X Coordinate Point B - BCX

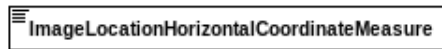

Field Reference: 9/RCC/BCX

Content Type: Data

XML Tag Name: ImageLocationHorizontalCoordinateMeasure

Data Type: N

Minimum Length: 1

Minimum Occurrences: 1

Value range: *n/a*

Code table: *n/a*

Base type: niem-xsd:integer

Field ID: [09.335-C]

Condition: Mandatory within a field

Defined in: xsd/niem/biometrics/1.0/biometrics.xsd

Special Characters: *n/a*

Maximum Length: 5

Maximum Occurrences: 1

Regular Expression: *n/a*

Namespace: <http://niem.gov/niem/biometrics/1.0>

XPath

```
/itl:PackageMinutiaeRecord
  ↳/biom:ExtendedFeatureSetMinutiae
    ↳/biom:MinutiaeRidgeCountConfidence
      ↳/biom:MinutiaLocationReferencePoint
        ↳/biom:ImageLocationHorizontalCoordinateMeasure
```

Summary

X coordinate for point B (units of 10 micrometers).

Valid Examples

```
<biom:ImageLocationHorizontalCoordinateMeasure>8855</biom:ImageLocationHorizontalCoordinateMeasure>
```

10.152. Y Coordinate Point B - BCY

 ImageLocationVerticalCoordinateMeasure
--

Field Reference: 9/RCC/BCY

Content Type: Data

XML Tag Name: ImageLocationVerticalCoordinateMeasure

Data Type: N

Minimum Length: 1

Minimum Occurrences: 1

Value range: *n/a*

Code table: *n/a*

Base type: niem-xsd:integer

Field ID: [09.335-D]

Condition: Mandatory within a field

Defined in: xsd/niem/biometrics/1.0/biometrics.xsd

Special Characters: *n/a*

Maximum Length: 5

Maximum Occurrences: 1

Regular Expression: *n/a*

Namespace: <http://niem.gov/niem/biometrics/1.0>

XPath

```
/itl:PackageMinutiaeRecord
  ↳/biom:ExtendedFeatureSetMinutiae
    ↳/biom:MinutiaeRidgeCountConfidence
      ↳/biom:MinutiaLocationReferencePoint
        ↳/biom:ImageLocationVerticalCoordinateMeasure
```

Summary

Y coordinate for point B (units of 10 micrometers).

Valid Examples

<code><biom:ImageLocationVerticalCoordinateMeasure>8855</biom:ImageLocationVerticalCoordinateMeasure></code>
--

10.153. Method of Ridge Counting - MORC

Field Reference: 9/RCC/MORC

Content Type: Data

XML Tag Name: MinutiaeRidgeCountMethodCode

Data Type: A

Minimum Length: 1

Minimum Occurrences: 1

Value range: *n/a*

Code table: see table [A.49](#)

Base type: biom:MinutiaeRidgeCountMethodCodeType

Field ID: [09.335-E]

Condition: Mandatory within a field

Defined in: [xsd/niem/biometrics/1.0/biometrics.xsd](#)

Special Characters: *n/a*

Maximum Length: 1

Maximum Occurrences: 1

Regular Expression: *n/a*

Namespace: <http://niem.gov/niem/biometrics/1.0>

XPath

```
/it1:PackageMinutiaeRecord
  ↳/biom:ExtendedFeatureSetMinutiae
    ↳/biom:MinutiaeRidgeCountConfidence
      ↳/biom:MinutiaeRidgeCountMethodCode
```

Summary

Method by which ridge counts were determined and/or validated.

Valid Examples

```
<biom:MinutiaeRidgeCountMethodCode>M</biom:MinutiaeRidgeCountMethodCode>
```

10.154. Confidence Value - MCV

Field Reference: 9/RCC/MCV

Content Type: Data

XML Tag Name: MinutiaeRidgeCountConfidenceValue

Data Type: N

Minimum Length: 1

Minimum Occurrences: 1

Value range: {0..99}

Code table: *n/a*

Base type: biom:MinutiaeRidgeCountConfidenceValueType

Field ID: [09.335-F]

Condition: Mandatory within a field

Defined in: xsd/niem/biometrics/1.0/biometrics.xsd

Special Characters: *n/a*

Maximum Length: 2

Maximum Occurrences: 1

Regular Expression: *n/a*

Namespace: <http://niem.gov/niem/biometrics/1.0>

XPath

```
/it1:PackageMinutiaeRecord
├── /biom:ExtendedFeatureSetMinutiae
│   └── /biom:MinutiaeRidgeCountConfidence
│       └── /biom:MinutiaeRidgeCountConfidenceValue
```

Summary

Confidence value for the ridge count ("0" = no confidence).

Valid Examples

```
<biom:MinutiaeRidgeCountConfidenceValue>57</biom:MinutiaeRidgeCountConfidenceValue>
```

10.155. EFS Dots (XML) - DOT

Field Reference: 9/DOT:X
Content Type: Set_X
XML Tag Name: MinutiaeDot
Data Type:
Minimum Length:
Minimum Occurrences: 0
Value range: *n/a*
Code table: *n/a*
Base type: biom:MinutiaeDotType

Field ID: [09.340:X]
Condition: Dependent (see table)
Defined in: xsd/niem/biometrics/1.0/biometrics.xsd
Special Characters: *n/a*
Maximum Length:
Maximum Occurrences: 999
Regular Expression: *n/a*

Namespace: <http://niem.gov/niem/biometrics/1.0>

Dependency table

Type of dependency	Value
Mandatory on Absence of other Field	9/NDOT:X

XPath

```

/it1:PackageMinutiaeRecord
  ↙/biom:ExtendedFeatureSetMinutiae
    ↙/biom:MinutiaeDot
    
```

Summary

EFS dot description.

10.156. Dot X Coordinate - DOX

 ImageLocationHorizontalCoordinateMeasure
--

Field Reference: 9/DOT/DOX**Content Type:** Data**XML Tag Name:** ImageLocationHorizontalCoordinateMeasure**Data Type:** N**Minimum Length:** 1**Minimum Occurrences:** 1**Value range:** *n/a***Code table:** *n/a***Base type:** niem-xsd:integer**Field ID:** [09.340-A]**Condition:** Mandatory within a field**Defined in:** xsd/niem/biometrics/1.0/biometrics.xsd**Special Characters:** *n/a***Maximum Length:** 5**Maximum Occurrences:** 1**Regular Expression:** *n/a***Namespace:** <http://niem.gov/niem/biometrics/1.0>

XPath

```
/itl:PackageMinutiaeRecord
  ↳/biom:ExtendedFeatureSetMinutiae
    ↳/biom:MinutiaeDot
      ↳/biom:ImageLocationHorizontalCoordinateMeasure
```

Summary

X coordinate of dot center (units of 10 micrometers).

Valid Examples

```
<biom:ImageLocationHorizontalCoordinateMeasure>56444</biom:ImageLocationHorizontalCoordinateMeasure>
```

10.157. Dot Y Coordinate - DOY

 ImageLocationVerticalCoordinateMeasure
--

Field Reference: 9/DOT/DOY**Content Type:** Data**XML Tag Name:** ImageLocationVerticalCoordinateMeasure**Data Type:** N**Minimum Length:** 1**Minimum Occurrences:** 1**Value range:** *n/a***Code table:** *n/a***Base type:** niem-xsd:integer**Field ID:** [09.340-B]**Condition:** Mandatory within a field**Defined in:** xsd/niem/biometrics/1.0/biometrics.xsd**Special Characters:** *n/a***Maximum Length:** 5**Maximum Occurrences:** 1**Regular Expression:** *n/a***Namespace:** <http://niem.gov/niem/biometrics/1.0>

XPath

```

/itl:PackageMinutiaeRecord
  ↳/biom:ExtendedFeatureSetMinutiae
    ↳/biom:MinutiaeDot
      ↳/biom:ImageLocationVerticalCoordinateMeasure
  
```

Summary

Y coordinate of dot center (units of 10 micrometers).

Valid Examples

```
<biom:ImageLocationVerticalCoordinateMeasure>56444</biom:ImageLocationVerticalCoordinateMeasure>
```

10.158. Dot Length - DOL

Field Reference: 9/DOT/DOL

Content Type: Data

XML Tag Name: MinutiaeDotLengthMeasure

Data Type: N

Minimum Length: 1

Minimum Occurrences: 0

Value range: {1..99}

Code table: *n/a*

Base type: niem-xsd:nonNegativeInteger

Field ID: [09.340-C]

Condition: Optional within a field

Defined in: xsd/niem/biometrics/1.0/biometrics.xsd

Special Characters: *n/a*

Maximum Length: 2

Maximum Occurrences: 1

Regular Expression: *n/a*

Namespace: <http://niem.gov/niem/biometrics/1.0>

XPath

```
/it1:PackageMinutiaeRecord  
  ↳/biom:ExtendedFeatureSetMinutiae  
    ↳/biom:MinutiaeDot  
      ↳/biom:MinutiaeDotLengthMeasure
```

Summary

Dot length along its longest dimension (units of 10 micrometers)

Valid Examples

```
<biom:MinutiaeDotLengthMeasure>95</biom:MinutiaeDotLengthMeasure>
```

10.159. EFS Incipient Ridges (XML) - INR

Field Reference: 9/INR:X	Field ID: [09.341:X]
Content Type: Set_X	Condition: Dependent (see table)
XML Tag Name: MinutiaeIncipientRidge	Defined in: xsd/niem/biometrics/1.0/biometrics.xsd
Data Type:	Special Characters: n/a
Minimum Length:	Maximum Length:
Minimum Occurrences: 0	Maximum Occurrences: 999
Value range: n/a	Regular Expression: n/a
Code table: n/a	
Base type: biom:MinutiaeIncipientRidgeType	Namespace: http://niem.gov/niem/biometrics/1.0

Dependency table

Type of dependency	Value
Mandatory on Absence of other Field	9/NINR:X

XPath

```
/it1:PackageMinutiaeRecord
  ↙/biom:ExtendedFeatureSetMinutiae
    ↙/biom:MinutiaeIncipientRidge
```

Summary

EFS incipient ridge information.

10.160. Minutia Location Point (XML)

Field Reference: 9/INR/X1C_9/INR/Y1C
Content Type: Set_X
XML Tag Name: MinutiaLocationPoint
Data Type:
Minimum Length:
Minimum Occurrences: 1
Value range: *n/a*
Code table: *n/a*
Base type: biom:ImageSegmentVertexType

Field ID: [09.341-A_09.341-B]
Condition: Mandatory within a field
Defined in: xsd/niem/biometrics/1.0/biometrics.xsd
Special Characters: *n/a*
Maximum Length:
Maximum Occurrences: 1
Regular Expression: *n/a*
Namespace: <http://niem.gov/niem/biometrics/1.0>

XPath

```
/it1:PackageMinutiaeRecord  
  ↙/biom:ExtendedFeatureSetMinutiae  
    ↙/biom:MinutiaeIncipientRidge  
      ↙/biom:MinutiaLocationPoint
```

Summary

Coordinates of incipient ridge endpoint A.

Notes

Applies to 9.341-A and 9.341-B

10.161. X Coordinate Point 1 - X1C

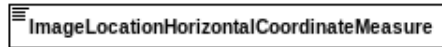

Field Reference: 9/INR/X1C

Content Type: Data

XML Tag Name: ImageLocationHorizontalCoordinateMeasure

Data Type: N

Minimum Length: 1

Minimum Occurrences: 1

Value range: *n/a*

Code table: *n/a*

Base type: niem-xsd:integer

Field ID: [09.341-A]

Condition: Mandatory within a field

Defined in: xsd/niem/biometrics/1.0/biometrics.xsd

Special Characters: *n/a*

Maximum Length: 5

Maximum Occurrences: 1

Regular Expression: *n/a*

Namespace: <http://niem.gov/niem/biometrics/1.0>

XPath

```
/itl:PackageMinutiaeRecord
  ↳/biom:ExtendedFeatureSetMinutiae
    ↳/biom:MinutiaeIncipientRidge
      ↳/biom:MinutiaLocationPoint
        ↳/biom:ImageLocationHorizontalCoordinateMeasure
```

Summary

X coordinate of one endpoint (units of 10 micrometers).

Valid Examples

```
<biom:ImageLocationHorizontalCoordinateMeasure>40000</biom:ImageLocationHorizontalCoordinateMeasure>
```

10.162. Y Coordinate Point 1 - Y1C

 ImageLocationVerticalCoordinateMeasure
--

Field Reference: 9/INR/Y1C

Content Type: Data

XML Tag Name: ImageLocationVerticalCoordinateMeasure

Data Type: N

Minimum Length: 1

Minimum Occurrences: 1

Value range: *n/a*

Code table: *n/a*

Base type: niem-xsd:integer

Field ID: [09.341-B]

Condition: Mandatory within a field

Defined in: xsd/niem/biometrics/1.0/biometrics.xsd

Special Characters: *n/a*

Maximum Length: 5

Maximum Occurrences: 1

Regular Expression: *n/a*

Namespace: <http://niem.gov/niem/biometrics/1.0>

XPath

```
/itl:PackageMinutiaeRecord
  ↳/biom:ExtendedFeatureSetMinutiae
    ↳/biom:MinutiaeIncipientRidge
      ↳/biom:MinutiaLocationPoint
        ↳/biom:ImageLocationVerticalCoordinateMeasure
```

Summary

Y coordinate of one endpoint (units of 10 micrometers).

Valid Examples

<code><biom:ImageLocationVerticalCoordinateMeasure>40000</biom:ImageLocationVerticalCoordinateMeasure></code>

10.163. Minutia Location Reference Point (XML)

Field Reference: 9/INR/X2C_9/INR/Y2C

Content Type: Set_X

XML Tag Name: MinutiaLocationReferencePoint

Data Type:

Minimum Length:

Minimum Occurrences: 1

Value range: *n/a*

Code table: *n/a*

Base type: biom:ImageSegmentVertexType

Field ID: [09.341-C_09.341-D]

Condition: Mandatory within a field

Defined in: xsd/niem/biometrics/1.0/biometrics.xsd

Special Characters: *n/a*

Maximum Length:

Maximum Occurrences: 1

Regular Expression: *n/a*

Namespace: <http://niem.gov/niem/biometrics/1.0>

XPath

```
/it1:PackageMinutiaeRecord
  ↙/biom:ExtendedFeatureSetMinutiae
    ↙/biom:MinutiaeIncipientRidge
      ↙/biom:MinutiaLocationReferencePoint
```

Summary

Coordinates of incipient ridge endpoint B.

Notes

Applies to 9.341-C and 9.341-D

10.164. X Coordinate Point 2 - X2C

 ImageLocationHorizontalCoordinateMeasure
--

Field Reference: 9/INR/X2C

Content Type: Data

XML Tag Name: ImageLocationHorizontalCoordinateMeasure

Data Type: N

Minimum Length: 1

Minimum Occurrences: 1

Value range: *n/a*

Code table: *n/a*

Base type: niem-xsd:integer

Field ID: [09.341-C]

Condition: Mandatory within a field

Defined in: xsd/niem/biometrics/1.0/biometrics.xsd

Special Characters: *n/a*

Maximum Length: 5

Maximum Occurrences: 1

Regular Expression: *n/a*

Namespace: <http://niem.gov/niem/biometrics/1.0>

XPath

```
/itl:PackageMinutiaeRecord
  ↳/biom:ExtendedFeatureSetMinutiae
    ↳/biom:MinutiaeIncipientRidge
      ↳/biom:MinutiaLocationReferencePoint
        ↳/biom:ImageLocationHorizontalCoordinateMeasure
```

Summary

X coordinate of other endpoint (units of 10 micrometers).

Valid Examples

<code><biom:ImageLocationHorizontalCoordinateMeasure>40000</biom:ImageLocationHorizontalCoordinateMeasure></code>

10.165. Y Coordinate Point 2 - Y2C

 ImageLocationVerticalCoordinateMeasure

Field Reference: 9/INR/Y2C**Content Type:** Data**XML Tag Name:** ImageLocationVerticalCoordinateMeasure**Data Type:** N**Minimum Length:** 1**Minimum Occurrences:** 1**Value range:** *n/a***Code table:** *n/a***Base type:** niem-xsd:integer**Field ID:** [09.341-D]**Condition:** Mandatory within a field**Defined in:** xsd/niem/biometrics/1.0/biometrics.xsd**Special Characters:** *n/a***Maximum Length:** 5**Maximum Occurrences:** 1**Regular Expression:** *n/a***Namespace:** <http://niem.gov/niem/biometrics/1.0>**XPath**

```

/itl:PackageMinutiaeRecord
  ↳/biom:ExtendedFeatureSetMinutiae
    ↳/biom:MinutiaeIncipientRidge
      ↳/biom:MinutiaLocationReferencePoint
        ↳/biom:ImageLocationVerticalCoordinateMeasure
  
```

Summary

Y coordinate of other endpoint (units of 10 micrometers).

Valid Examples

<pre><biom:ImageLocationVerticalCoordinateMeasure>40000</biom:ImageLocationVerticalCoordinateMeasure></pre>

10.166. EFS Creases and Linear Discontinuities (XML) - CLD

Field Reference: 9/CLD:X	Field ID: [09.342:X]
Content Type: Set_X	Condition: Dependent (see table)
XML Tag Name: MinutiaeFlexionCrease	Defined in: xsd/niem/biometrics/1.0/biometrics.xsd
Data Type:	Special Characters: <i>n/a</i>
Minimum Length:	Maximum Length:
Minimum Occurrences: 0	Maximum Occurrences: 999
Value range: <i>n/a</i>	Regular Expression: <i>n/a</i>
Code table: <i>n/a</i>	
Base type: biom:MinutiaeFlexionCreaseType	Namespace: http://niem.gov/niem/biometrics/1.0

Dependency table

Type of dependency	Value
Mandatory on Absence of other Field	9/NCLD:X

XPath

```
/it1:PackageMinutiaeRecord
  ↙/biom:ExtendedFeatureSetMinutiae
    ↙/biom:MinutiaeFlexionCrease
```

Summary

Defines permanent flexion creases and linear discontinuities

10.167. Minutia Location Point (XML)

Field Reference: 9/CLD/X1D_9/CLD/Y1D
Content Type: Set_X
XML Tag Name: MinutiaLocationPoint
Data Type:
Minimum Length:
Minimum Occurrences: 1
Value range: *n/a*
Code table: *n/a*
Base type: biom:ImageSegmentVertexType

Field ID: [09.342-A_09.342-B]
Condition: Mandatory within a field
Defined in: xsd/niem/biometrics/1.0/biometrics.xsd
Special Characters: *n/a*
Maximum Length:
Maximum Occurrences: 1
Regular Expression: *n/a*
Namespace: <http://niem.gov/niem/biometrics/1.0>

XPath

```
/it1:PackageMinutiaeRecord  
  ↙/biom:ExtendedFeatureSetMinutiae  
    ↙/biom:MinutiaeFlexionCrease  
      ↙/biom:MinutiaLocationPoint
```

Summary

Coordinates of crease/linear discontinuity endpoint A

Notes

Applies to 9.342-A and 9.342-B

10.168. X Coordinate Point 1 - X1D

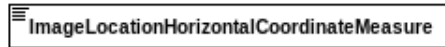

Field Reference: 9/CLD/X1D

Content Type: Data

XML Tag Name: ImageLocationHorizontalCoordinateMeasure

Data Type: N

Minimum Length: 1

Minimum Occurrences: 1

Value range: *n/a*

Code table: *n/a*

Base type: niem-xsd:integer

Field ID: [09.342-A]

Condition: Mandatory within a field

Defined in: xsd/niem/biometrics/1.0/biometrics.xsd

Special Characters: *n/a*

Maximum Length: 5

Maximum Occurrences: 1

Regular Expression: *n/a*

Namespace: <http://niem.gov/niem/biometrics/1.0>

XPath

```
/itl:PackageMinutiaeRecord
  ↳/biom:ExtendedFeatureSetMinutiae
    ↳/biom:MinutiaeFlexionCrease
      ↳/biom:MinutiaLocationPoint
        ↳/biom:ImageLocationHorizontalCoordinateMeasure
```

Summary

X coordinate of one endpoint (units of 10 micrometers).

Valid Examples

```
<biom:ImageLocationHorizontalCoordinateMeasure>7700</biom:ImageLocationHorizontalCoordinateMeasure>
```

10.169. Y Coordinate Point 1 - Y1D

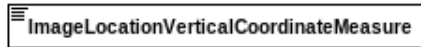

Field Reference: 9/CLD/Y1D

Content Type: Data

XML Tag Name: ImageLocationVerticalCoordinateMeasure

Data Type: N

Minimum Length: 1

Minimum Occurrences: 1

Value range: *n/a*

Code table: *n/a*

Base type: niem-xsd:integer

Field ID: [09.342-B]

Condition: Mandatory within a field

Defined in: xsd/niem/biometrics/1.0/biometrics.xsd

Special Characters: *n/a*

Maximum Length: 5

Maximum Occurrences: 1

Regular Expression: *n/a*

Namespace: <http://niem.gov/niem/biometrics/1.0>

XPath

```
/itl:PackageMinutiaeRecord
  ↳/biom:ExtendedFeatureSetMinutiae
    ↳/biom:MinutiaeFlexionCrease
      ↳/biom:MinutiaLocationPoint
        ↳/biom:ImageLocationVerticalCoordinateMeasure
```

Summary

Y coordinate of one endpoint (units of 10 micrometers).

Valid Examples

```
<biom:ImageLocationVerticalCoordinateMeasure>4700</biom:ImageLocationVerticalCoordinateMeasure>
```

10.170. Minutia Location Reference Point (XML)

Field Reference: 9/CLD/X2D_9/CLD/Y2D
Content Type: Set_X
XML Tag Name: MinutiaLocationReferencePoint
Data Type:
Minimum Length:
Minimum Occurrences: 1
Value range: *n/a*
Code table: *n/a*
Base type: biom:ImageSegmentVertexType

Field ID: [09.342-C_09.342-D]
Condition: Mandatory within a field
Defined in: xsd/niem/biometrics/1.0/biometrics.xsd
Special Characters: *n/a*
Maximum Length:
Maximum Occurrences: 1
Regular Expression: *n/a*
Namespace: <http://niem.gov/niem/biometrics/1.0>

XPath

```
/it1:PackageMinutiaeRecord  
  ↙/biom:ExtendedFeatureSetMinutiae  
    ↙/biom:MinutiaeFlexionCrease  
      ↙/biom:MinutiaLocationReferencePoint
```

Summary

Coordinates of crease/linear discontinuity endpoint B.

Notes

Applies to 9.342-C and 9.342-D

10.171. X Coordinate Point 2 - X2D

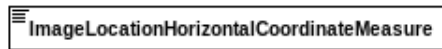

Field Reference: 9/CLD/X2D

Content Type: Data

XML Tag Name: ImageLocationHorizontalCoordinateMeasure

Data Type: N

Minimum Length: 1

Minimum Occurrences: 1

Value range: *n/a*

Code table: *n/a*

Base type: niem-xsd:integer

Field ID: [09.342-C]

Condition: Mandatory within a field

Defined in: xsd/niem/biometrics/1.0/biometrics.xsd

Special Characters: *n/a*

Maximum Length: 5

Maximum Occurrences: 1

Regular Expression: *n/a*

Namespace: <http://niem.gov/niem/biometrics/1.0>

XPath

```
/itl:PackageMinutiaeRecord
  ↳/biom:ExtendedFeatureSetMinutiae
    ↳/biom:MinutiaeFlexionCrease
      ↳/biom:MinutiaLocationReferencePoint
        ↳/biom:ImageLocationHorizontalCoordinateMeasure
```

Summary

X coordinate of other endpoint (units of 10 micrometers).

Valid Examples

```
<biom:ImageLocationHorizontalCoordinateMeasure>7700</biom:ImageLocationHorizontalCoordinateMeasure>
```

10.172. Y Coordinate Point 2 - Y2D

 ImageLocationVerticalCoordinateMeasure

Field Reference: 9/CLD/Y2D

Content Type: Data

XML Tag Name: ImageLocationVerticalCoordinateMeasure

Data Type: N

Minimum Length: 1

Minimum Occurrences: 1

Value range: *n/a*

Code table: *n/a*

Base type: niem-xsd:integer

Field ID: [09.342-D]

Condition: Mandatory within a field

Defined in: xsd/niem/biometrics/1.0/biometrics.xsd

Special Characters: *n/a*

Maximum Length: 5

Maximum Occurrences: 1

Regular Expression: *n/a*

Namespace: <http://niem.gov/niem/biometrics/1.0>

XPath

```
/itl:PackageMinutiaeRecord
├─/biom:ExtendedFeatureSetMinutiae
│   └─/biom:MinutiaeFlexionCrease
│       └─/biom:MinutiaLocationReferencePoint
│           └─/biom:ImageLocationVerticalCoordinateMeasure
```

Summary

Y coordinate of other endpoint (units of 10 micrometers).

Valid Examples

```
<biom:ImageLocationVerticalCoordinateMeasure>4700</biom:ImageLocationVerticalCoordinateMeasure>
```

10.173. Type - TPD

Field Reference: 9/CLD/TPD

Content Type: Data

XML Tag Name: MinutiaeFlexionCreaseCategoryCode

Data Type: AN

Minimum Length: 2

Minimum Occurrences: 1

Value range: *n/a*

Code table: see table [A.8](#)

Base type: biom:MinutiaeFlexionCreaseCategoryCodeType

Field ID: [09.342-E]

Condition: Mandatory within a field

Defined in: [xsd/niem/biometrics/1.0/biometrics.xsd](#)

Special Characters: *n/a*

Maximum Length: 5

Maximum Occurrences: 1

Regular Expression: *n/a*

Namespace: <http://niem.gov/niem/biometrics/1.0>

XPath

```
/it1:PackageMinutiaeRecord
  ↳/biom:ExtendedFeatureSetMinutiae
    ↳/biom:MinutiaeFlexionCrease
      ↳/biom:MinutiaeFlexionCreaseCategoryCode
```

Summary

Type of permanent flexion crease.

Valid Examples

```
<biom:MinutiaeFlexionCreaseCategoryCode>PDC07</biom:MinutiaeFlexionCreaseCategoryCode>
```

10.174. EFS Ridge Edge Features (XML) - REF

Field Reference: 9/REF:X	Field ID: [09.343:X]
Content Type: Set_X	Condition: Dependent (see table)
XML Tag Name: MinutiaeRidgeEdgeOrDiscontinuity	Defined in: xsd/niem/biometrics/1.0/biometrics.xsd
Data Type:	Special Characters: n/a
Minimum Length:	Maximum Length:
Minimum Occurrences: 0	Maximum Occurrences: 999
Value range: n/a	Regular Expression: n/a
Code table: n/a	
Base type: biom:MinutiaeRidgeEdgeOrDiscontinuityType	Namespace: http://niem.gov/niem/biometrics/1.0

Dependency table

Type of dependency	Value
Mandatory on Absence of other Field	9/NREF:X

XPath

```

/it1:PackageMinutiaeRecord
  ↙/biom:ExtendedFeatureSetMinutiae
    ↙/biom:MinutiaeRidgeEdgeOrDiscontinuity
    
```

Summary

EFS ridge end features (i.e., protrusions, indentations, discontinuities) data.

10.175. X Coordinate - CLX

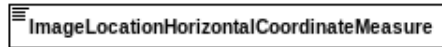

Field Reference: 9/REF/CLX

Content Type: Data

XML Tag Name: ImageLocationHorizontalCoordinateMeasure

Data Type: N

Minimum Length: 1

Minimum Occurrences: 1

Value range: *n/a*

Code table: *n/a*

Base type: niem-xsd:integer

Field ID: [09.343-A]

Condition: Mandatory within a field

Defined in: xsd/niem/biometrics/1.0/biometrics.xsd

Special Characters: *n/a*

Maximum Length: 5

Maximum Occurrences: 1

Regular Expression: *n/a*

Namespace: <http://niem.gov/niem/biometrics/1.0>

XPath

```
/itl:PackageMinutiaeRecord
  ↳/biom:ExtendedFeatureSetMinutiae
    ↳/biom:MinutiaeRidgeEdgeOrDiscontinuity
      ↳/biom:ImageLocationHorizontalCoordinateMeasure
```

Summary

X coordinate of the feature center (units of 10 micrometers).

Valid Examples

```
<biom:ImageLocationHorizontalCoordinateMeasure>40000</biom:ImageLocationHorizontalCoordinateMeasure>
```

10.176. Y Coordinate - CLY

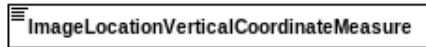

Field Reference: 9/REF/CLY

Content Type: Data

XML Tag Name: ImageLocationVerticalCoordinateMeasure

Data Type: N

Minimum Length: 1

Minimum Occurrences: 1

Value range: *n/a*

Code table: *n/a*

Base type: niem-xsd:integer

Field ID: [09.343-B]

Condition: Mandatory within a field

Defined in: xsd/niem/biometrics/1.0/biometrics.xsd

Special Characters: *n/a*

Maximum Length: 5

Maximum Occurrences: 1

Regular Expression: *n/a*

Namespace: <http://niem.gov/niem/biometrics/1.0>

XPath

```
/itl:PackageMinutiaeRecord
  ↳/biom:ExtendedFeatureSetMinutiae
    ↳/biom:MinutiaeRidgeEdgeOrDiscontinuity
      ↳/biom:ImageLocationVerticalCoordinateMeasure
```

Summary

Y coordinate of the feature center (units of 10 micrometers).

Valid Examples

```
<biom:ImageLocationVerticalCoordinateMeasure>40000</biom:ImageLocationVerticalCoordinateMeasure>
```

10.177. Type - CLT

Field Reference: 9/REF/CLT	Field ID: [09.343-C]
Content Type: Data	Condition: Mandatory within a field
XML Tag Name: MinutiaeRidgeEdgeOrDiscontinuityCategoryCode	Defined in: xsd/niem/biometrics/1.0/biometrics.xsd
Data Type: A	Special Characters: <i>n/a</i>
Minimum Length: 1	Maximum Length: 1
Minimum Occurrences: 1	Maximum Occurrences: 1
Value range: <i>n/a</i>	Regular Expression: <i>n/a</i>
Code table: see table A.53	
Base type: <code>biom:MinutiaeRidgeEdgeOrDiscontinuityCategoryCode</code>	Namespace: http://niem.gov/niem/biometrics/1.0

XPath

```
/it1:PackageMinutiaeRecord  
  ↳/biom:ExtendedFeatureSetMinutiae  
    ↳/biom:MinutiaeRidgeEdgeOrDiscontinuity  
      ↳/biom:MinutiaeRidgeEdgeOrDiscontinuityCategoryCode
```

Summary

Type of feature.

Valid Examples

```
<biom:MinutiaeRidgeEdgeOrDiscontinuityCategoryCode>I</biom:MinutiaeRidgeEdgeOrDiscontinuityCategoryCode>
```

10.178. EFS No Pores Present (XML) - NPOR

Field Reference: 9/NPOR:X	Field ID: [09.344:X]
Content Type: Data_X	Condition: Dependent (see table)
XML Tag Name: MinutiaeNoPoresPresentIndicator	Defined in: xsd/niem/biometrics/1.0/biometrics.xsd
Data Type: Y	Special Characters: <i>n/a</i>
Minimum Length: 1	Maximum Length: 4
Minimum Occurrences: 0	Maximum Occurrences: 1
Value range: {"true",1}	Regular Expression: <i>n/a</i>
Code table: <i>n/a</i>	
Base type: niem-xsd:boolean	Namespace: http://niem.gov/niem/biometrics/1.0

Dependency table

Type of dependency	Value
Mandatory on Absence of other Field	9/POR:X

XPath

```
/it1:PackageMinutiaeRecord
  ↳/biom:ExtendedFeatureSetMinutiae
    ↳/biom:MinutiaeNoPoresPresentIndicator
```

Summary

Indicates if no EFS pores can be discerned.

Notes

Omit field if false

Valid Examples

```
<biom:MinutiaeNoPoresPresentIndicator>true</biom:MinutiaeNoPoresPresentIndicator>
```

10.179. EFS Pores (XML) - POR

Field Reference: 9/POR:X
Content Type: Set_X
XML Tag Name: MinutiaePore
Data Type:
Minimum Length:
Minimum Occurrences: 0
Value range: *n/a*
Code table: *n/a*
Base type: biom:MinutiaePoreType

Field ID: [09.345:X]
Condition: Dependent (see table)
Defined in: xsd/niem/biometrics/1.0/biometrics.xsd
Special Characters: *n/a*
Maximum Length:
Maximum Occurrences: 9999
Regular Expression: *n/a*

Namespace: <http://niem.gov/niem/biometrics/1.0>

Dependency table

Type of dependency	Value
Mandatory on Absence of other Field	9/NPOR:X

XPath

```

/it1:PackageMinutiaeRecord
  ↙/biom:ExtendedFeatureSetMinutiae
    ↙/biom:MinutiaePore
    
```

Summary

EFS pore data.

10.180. X Coordinate - POX

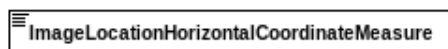

Field Reference: 9/POR/POX

Content Type: Data

XML Tag Name: ImageLocationHorizontalCoordinateMeasure

Data Type: N

Minimum Length: 1

Minimum Occurrences: 1

Value range: *n/a*

Code table: *n/a*

Base type: niem-xsd:integer

Field ID: [09.345-A]

Condition: Mandatory within a field

Defined in: xsd/niem/biometrics/1.0/biometrics.xsd

Special Characters: *n/a*

Maximum Length: 5

Maximum Occurrences: 1

Regular Expression: *n/a*

Namespace: <http://niem.gov/niem/biometrics/1.0>

XPath

```
/itl:PackageMinutiaeRecord
  ↳/biom:ExtendedFeatureSetMinutiae
    ↳/biom:MinutiaePore
      ↳/biom:ImageLocationHorizontalCoordinateMeasure
```

Summary

X coordinate of pore center (units of 10 micrometers).

Valid Examples

```
<biom:ImageLocationHorizontalCoordinateMeasure>40000</biom:ImageLocationHorizontalCoordinateMeasure>
```

10.181. Y Coordinate - POY

 ImageLocationVerticalCoordinateMeasure

Field Reference: 9/POR/POY

Content Type: Data

XML Tag Name: ImageLocationVerticalCoordinateMeasure

Data Type: N

Minimum Length: 1

Minimum Occurrences: 1

Value range: *n/a*

Code table: *n/a*

Base type: niem-xsd:integer

Field ID: [09.345-B]

Condition: Mandatory within a field

Defined in: xsd/niem/biometrics/1.0/biometrics.xsd

Special Characters: *n/a*

Maximum Length: 5

Maximum Occurrences: 1

Regular Expression: *n/a*

Namespace: <http://niem.gov/niem/biometrics/1.0>

XPath

```
/itl:PackageMinutiaeRecord
  ↳/biom:ExtendedFeatureSetMinutiae
    ↳/biom:MinutiaePore
      ↳/biom:ImageLocationVerticalCoordinateMeasure
```

Summary

Y coordinate of pore center (units of 10 micrometers).

Valid Examples

```
<biom:ImageLocationVerticalCoordinateMeasure>40000</biom:ImageLocationVerticalCoordinateMeasure>
```

10.182. EFS No Dots Present (XML) - NDOT

Field Reference: 9/NDOT:X	Field ID: [09.346:X]
Content Type: Data_X	Condition: Dependent (see table)
XML Tag Name: MinutiaeNoDotsPresentIndicator	Defined in: xsd/niem/biometrics/1.0/biometrics.xsd
Data Type: Y	Special Characters: <i>n/a</i>
Minimum Length: 1	Maximum Length: 4
Minimum Occurrences: 0	Maximum Occurrences: 1
Value range: {"true",1}	Regular Expression: <i>n/a</i>
Code table: <i>n/a</i>	
Base type: niem-xsd:boolean	Namespace: http://niem.gov/niem/biometrics/1.0

Dependency table

Type of dependency	Value
Mandatory on Absence of other Field	9/DOT:X

XPath

```
/it1:PackageMinutiaeRecord
  ↳/biom:ExtendedFeatureSetMinutiae
    ↳/biom:MinutiaeNoDotsPresentIndicator
```

Summary

Indicates if no EFS dots can be discerned.

Notes

Omit field if false

Valid Examples

```
<biom:MinutiaeNoDotsPresentIndicator>true</biom:MinutiaeNoDotsPresentIndicator>
```

10.183. EFS No Incipient Ridges Present (XML) - NINR

Field Reference: 9/NINR:X	Field ID: [09.347:X]
Content Type: Data_X	Condition: Dependent (see table)
XML Tag Name: MinutiaeNoIncipientRidgesPresentIndicator	Defined in: xsd/niem/biometrics/1.0/biometrics.xsd
Data Type: Y	Special Characters: <i>n/a</i>
Minimum Length: 1	Maximum Length: 4
Minimum Occurrences: 0	Maximum Occurrences: 1
Value range: {"true",1}	Regular Expression: <i>n/a</i>
Code table: <i>n/a</i>	
Base type: niem-xsd:boolean	Namespace: http://niem.gov/niem/biometrics/1.0

Dependency table

Type of dependency	Value
Mandatory on Absence of other Field	9/INR:X

XPath

```
/it1:PackageMinutiaeRecord
  ↳/biom:ExtendedFeatureSetMinutiae
    ↳/biom:MinutiaeNoIncipientRidgesPresentIndicator
```

Summary

Indicates if no EFS incipient ridges can be discerned.

Notes

Omit field if false

Valid Examples

```
<biom:MinutiaeNoIncipientRidgesPresentIndicator>true</biom:MinutiaeNoIncipientRidgesPresentIndicator>
```

10.184. EFS No Creases Present (XML) - NCLD

<p>Field Reference: 9/NCLD:X Content Type: Data_X XML Tag Name: MinutiaeNoCreasesPresentIndicator Data Type: Y Minimum Length: 1 Minimum Occurrences: 0 Value range: {"true",1} Code table: n/a Base type: niem-xsd:boolean</p>	<p>Field ID: [09.348:X] Condition: Dependent (see table) Defined in: xsd/niem/biometrics/1.0/biometrics.xsd Special Characters: n/a Maximum Length: 4 Maximum Occurrences: 1 Regular Expression: n/a Namespace: http://niem.gov/niem/biometrics/1.0</p>
--	--

Dependency table

Type of dependency	Value
Mandatory on Absence of other Field	9/CLD:X

XPath

```
/it1:PackageMinutiaeRecord
  ↙/biom:ExtendedFeatureSetMinutiae
    ↙/biom:MinutiaeNoCreasesPresentIndicator
```

Summary

Indicates if no EFS creases or linear discontinuities can be discerned.

Notes

Omit field if false

Valid Examples

```
<biom:MinutiaeNoCreasesPresentIndicator>true</biom:MinutiaeNoCreasesPresentIndicator>
```

10.185. EFS No Ridge Edge Features Present (XML) - NREF

Field Reference: 9/NREF:X	Field ID: [09.349:X]
Content Type: Data_X	Condition: Dependent (see table)
XML Tag Name: MinutiaeNoRidgeEdgeFeaturesPresentIndicator	Defined in: xsd/niem/biometrics/1.0/biometrics.xsd
Data Type: Y	Special Characters: <i>n/a</i>
Minimum Length: 1	Maximum Length: 4
Minimum Occurrences: 0	Maximum Occurrences: 1
Value range: {"true",1}	Regular Expression: <i>n/a</i>
Code table: <i>n/a</i>	
Base type: niem-xsd:boolean	Namespace: http://niem.gov/niem/biometrics/1.0

Dependency table

Type of dependency	Value
Mandatory on Absence of other Field	9/REF:X

XPath

```
/it1:PackageMinutiaeRecord
  ↳/biom:ExtendedFeatureSetMinutiae
    ↳/biom:MinutiaeNoRidgeEdgeFeaturesPresentIndicator
```

Summary

Indicates if no EFS ridge edge features can be discerned.

Notes

Omit field if false

Valid Examples

```
<biom:MinutiaeNoRidgeEdgeFeaturesPresentIndicator>true</biom:MinutiaeNoRidgeEdgeFeaturesPresentIndicator>
```

10.186. EFS Method of Feature Detection - MFD

Field Reference: 9/MFD	Field ID: [09.350]
Content Type: Set	Condition: Dependent (see table)
XML Tag Name: MinutiaeFeatureDetection	Defined in: xsd/niem/biometrics/1.0/biometrics.xsd
Data Type:	Special Characters: <i>n/a</i>
Minimum Length:	Maximum Length:
Minimum Occurrences: 0	Maximum Occurrences: 99
Value range: <i>n/a</i>	Regular Expression: <i>n/a</i>
Code table: <i>n/a</i>	
Base type: biom:MinutiaeFeatureDetectionType	Namespace: http://niem.gov/niem/biometrics/1.0

Dependency table

Type of dependency	Value
Optional on Presence of other Field	9/ROI

XPath

```

/itl:PackageMinutiaeRecord
  ↙/biom:ExtendedFeatureSetMinutiae
    ↙/biom:MinutiaeFeatureDetection
    
```

Summary

Method(s) by which EFS features were detected and/or edited. Each time fields are created or modified, the date and name of the automated algorithm or human examiner is noted in a new data entry repeating subfield).

10.187. Field - FIE

Field Reference: 9/MFD/FIE

Content Type: Data

XML Tag Name: MinutiaeFeatureDetectionFieldListText

Data Type: ANS

Minimum Length: 3

Minimum Occurrences: 1

Value range: *n/a*

Code table: *n/a*

Base type: nc:TextType

Field ID: [09.350-A]

Condition: Mandatory within a field

Defined in: xsd/niem/biometrics/1.0/biometrics.xsd

Special Characters: [.,]

Maximum Length: 999

Maximum Occurrences: 1

Regular Expression: ("ALL")|(9.3\d\d(9.3\d\d)*)

Namespace: <http://niem.gov/niem/biometrics/1.0>

XPath

```
/itl:PackageMinutiaeRecord
  ↳/biom:ExtendedFeatureSetMinutiae
    ↳/biom:MinutiaeFeatureDetection
      ↳/biom:MinutiaeFeatureDetectionFieldListText
```

Summary

Fields which correspond to method noted.

10.188. Method - FME

Field Reference: 9/MFD/FME	Field ID: [09.350-B]
Content Type: Data	Condition: Mandatory within a field
XML Tag Name: MinutiaeFeatureDetectionMethodCode	Defined in: xsd/niem/biometrics/1.0/biometrics.xsd
Data Type: A	Special Characters: <i>n/a</i>
Minimum Length: 3	Maximum Length: 4
Minimum Occurrences: 1	Maximum Occurrences: 1
Value range: <i>n/a</i>	Regular Expression: <i>n/a</i>
Code table: see table A.36	
Base type: biom:MinutiaeFeatureDetectionMethodCodeType	Namespace: http://niem.gov/niem/biometrics/1.0

XPath

```
/itl:PackageMinutiaeRecord  
  ↳/biom:ExtendedFeatureSetMinutiae  
    ↳/biom:MinutiaeFeatureDetection  
      ↳/biom:MinutiaeFeatureDetectionMethodCode
```

Summary

Method by which fingerprint features were detected and encoded.

Valid Examples

```
<biom:MinutiaeFeatureDetectionMethodCode>EDIT</biom:MinutiaeFeatureDetectionMethodCode>
```

10.189. Algorithm Vendor - FAV

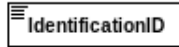

Field Reference: 9/MFD/FAV
Content Type: Data
XML Tag Name: IdentificationID
Data Type: U
Minimum Length: 1
Minimum Occurrences: 0
Value range: *n/a*
Code table: *n/a*
Base type: niem-xsd:string

Field ID: [09.350-C]
Condition: ?
Defined in: xsd/niem/niem-core/2.0/niem-core.xsd
Special Characters: *n/a*
Maximum Length: 40
Maximum Occurrences: 1
Regular Expression: *n/a*

Namespace: <http://niem.gov/niem/niem-core/2.0>

Dependency table

Type of dependency	Value
Optional on Value of other Field, should not be set otherwise.	[9/MFD/FME]IN{"AUTO","REV","EDIT"}

XPath

```

/itl:PackageMinutiaeRecord
  ↳/biom:ExtendedFeatureSetMinutiae
    ↳/biom:MinutiaeFeatureDetection
      ↳/biom:MinutiaeAlgorithmVendorIdentification
        ↳/nc:IdentificationID
  
```

Summary

Vendor of encoding algorithm.

10.190. Algorithm - FAL

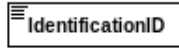

Field Reference: 9/MFD/FAL
Content Type: Data
XML Tag Name: IdentificationID
Data Type: U
Minimum Length: 1
Minimum Occurrences: 0
Value range: *n/a*
Code table: *n/a*
Base type: niem-xsd:string

Field ID: [09.350-D]
Condition: ?
Defined in: xsd/niem/niem-core/2.0/niem-core.xsd
Special Characters: *n/a*
Maximum Length: 40
Maximum Occurrences: 1
Regular Expression: *n/a*

Namespace: <http://niem.gov/niem/niem-core/2.0>

Dependency table

Type of dependency	Value
Optional on Value of other Field, should not be set otherwise.	[9/MFD/FME]IN{"AUTO","REV","EDIT"}

XPath

```

/itl:PackageMinutiaeRecord
  ↳/biom:ExtendedFeatureSetMinutiae
    ↳/biom:MinutiaeFeatureDetection
      ↳/biom:MinutiaeAlgorithmIdentification
        ↳/nc:IdentificationID
    
```

Summary

Algorithm name and version.

10.191. Minutiae Examiner (XML)

Field Reference: 9/MFD/ESN_9/MFD/EGN
Content Type: Set_X
XML Tag Name: PersonName
Data Type:
Minimum Length:
Minimum Occurrences: 0
Value range: *n/a*
Code table: *n/a*
Base type: nc:PersonNameType

Field ID: [09.350-E_09.350-F]
Condition: Optional within a field
Defined in: xsd/niem/niem-core/2.0/niem-core.xsd
Special Characters: *n/a*
Maximum Length:
Maximum Occurrences: 1
Regular Expression: *n/a*

Namespace: <http://niem.gov/niem/niem-core/2.0>

XPath

```
/it1:PackageMinutiaeRecord  
  ↙/biom:ExtendedFeatureSetMinutiae  
    ↙/biom:MinutiaeFeatureDetection  
      ↙/biom:MinutiaeExaminer  
        ↙/nc:PersonName
```

Summary

Minutiae examiner name.

Notes

Applies to 9.350-E and 9.350-F

10.192. Examiner Surname - ESN

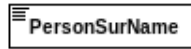

Field Reference: 9/MFD/ESN
Content Type: Data
XML Tag Name: PersonSurName
Data Type: U
Minimum Length: 1
Minimum Occurrences: 0
Value range: *n/a*
Code table: *n/a*
Base type: nc:PersonNameTextType

Field ID: [09.350-E]
Condition: ?
Defined in: xsd/niem/niem-core/2.0/niem-core.xsd
Special Characters: *n/a*
Maximum Length: 40
Maximum Occurrences: 1
Regular Expression: *n/a*
Namespace: <http://niem.gov/niem/niem-core/2.0>

Dependency table

Type of dependency	Value
Optional on Value of other Field, should not be set otherwise.	[9/MFD/FME]IN{"MAN","REV","EDIT"}

XPath

```

/itl:PackageMinutiaeRecord
├─/biom:ExtendedFeatureSetMinutiae
│   └─/biom:MinutiaeFeatureDetection
│       └─/biom:MinutiaeExaminer
│           └─/nc:PersonName
│               └─/nc:PersonSurName
    
```

Summary

Last name of fingerprint examiner.

Valid Examples

```
<nc:PersonSurName>Smith</nc:PersonSurName>
```

10.193. Examiner Given Name - EGN

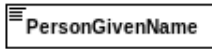

Field Reference: 9/MFD/EGN
Content Type: Data
XML Tag Name: PersonGivenName
Data Type: U
Minimum Length: 1
Minimum Occurrences: 0
Value range: *n/a*
Code table: *n/a*
Base type: nc:PersonNameTextType

Field ID: [09.350-F]
Condition: ?
Defined in: xsd/niem/niem-core/2.0/niem-core.xsd
Special Characters: *n/a*
Maximum Length: 40
Maximum Occurrences: 1
Regular Expression: *n/a*
Namespace: <http://niem.gov/niem/niem-core/2.0>

Dependency table

Type of dependency	Value
Optional on Value of other Field, should not be set otherwise.	[9/MFD/FME]IN{"MAN","REV","EDIT"}

XPath

```

/itl:PackageMinutiaeRecord
├─/biom:ExtendedFeatureSetMinutiae
│   └─/biom:MinutiaeFeatureDetection
│       └─/biom:MinutiaeExaminer
│           └─/nc:PersonName
│               └─/nc:PersonGivenName
    
```

Summary

Given name or first and middle names of fingerprint examiner.

Valid Examples

```
<nc:PersonGivenName>John</nc:PersonGivenName>
```

10.194. Examiner Affiliation - EAF

 OrganizationName

Field Reference: 9/MFD/EAF

Content Type: Data

XML Tag Name: OrganizationName

Data Type: U

Minimum Length: 1

Minimum Occurrences: 0

Value range: *n/a*

Code table: *n/a*

Base type: nc:TextType

Field ID: [09.350-G]

Condition: ?

Defined in: xsd/niem/niem-core/2.0/niem-core.xsd

Special Characters: *n/a*

Maximum Length: 99

Maximum Occurrences: 1

Regular Expression: *n/a*

Namespace: <http://niem.gov/niem/niem-core/2.0>

Dependency table

Type of dependency	Value
Optional on Value of other Field, should not be set otherwise.	[9/MFD/FME]IN{"MAN","REV","EDIT"}

XPath

```
/itl:PackageMinutiaeRecord
  ↳/biom:ExtendedFeatureSetMinutiae
    ↳/biom:MinutiaeFeatureDetection
      ↳/biom:MinutiaeExaminerAffiliation
        ↳/nc:OrganizationName
```

Summary

Employer or organizational affiliation of examiner.

Valid Examples

```
<nc:OrganizationName>FBI</nc:OrganizationName>
```

10.195. Date and Time (XML) - EMT

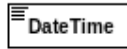

Field Reference: 9/MFD/EMT:X
Content Type: Data_X
XML Tag Name: DateTime
Data Type: ANS
Minimum Length: 20
Minimum Occurrences: 0
Value range: *n/a*
Code table: *n/a*
Base type: [niem-xsd:dateTime](#)

Field ID: [09.350-H:X]
Condition: Optional within a field
Defined in: [xsd/niem/niem-core/2.0/niem-core.xsd](#)
Special Characters: [-:]
Maximum Length: 20
Maximum Occurrences: 1
Regular Expression: \d{4}-\d{2}-\d{2}T\d{2}:\d{2}:\d{2}Z
Namespace: <http://niem.gov/niem/niem-core/2.0>

XPath

```
/itl:PackageMinutiaeRecord  
  ↳/biom:ExtendedFeatureSetMinutiae  
    ↳/biom:MinutiaeFeatureDetection  
      ↳/biom:MinutiaeFeatureDetectionDateTime  
        ↳/nc:DateTime
```

Summary

Date and time determination was made.

Valid Examples

```
<nc:DateTime>2007-01-01T00:00:01Z</nc:DateTime>
```

10.196. Notes - NTS

Field Reference: 9/MFD/NTS
Content Type: Data
XML Tag Name: MinutiaeCommentText
Data Type: U
Minimum Length: 1
Minimum Occurrences: 0
Value range: *n/a*
Code table: *n/a*
Base type: nc:TextType

Field ID: [09.350-I]
Condition: Optional within a field
Defined in: xsd/niem/biometrics/1.0/biometrics.xsd
Special Characters: *n/a*
Maximum Length: 99
Maximum Occurrences: 1
Regular Expression: *n/a*
Namespace: <http://niem.gov/niem/biometrics/1.0>

XPath

```
/itl:PackageMinutiaeRecord  
  ↳/biom:ExtendedFeatureSetMinutiae  
    ↳/biom:MinutiaeFeatureDetection  
      ↳/biom:MinutiaeCommentText
```

Summary

Additional information regarding the detection or modification of features.

10.197. EFS Comment - COM**Field Reference:** 9/COM**Content Type:** Data**XML Tag Name:** MinutiaeCommentText**Data Type:** U**Minimum Length:** 1**Minimum Occurrences:** 0**Value range:** *n/a***Code table:** *n/a***Base type:** nc:TextType**Field ID:** [09.351]**Condition:** Dependent (see table)**Defined in:** xsd/niem/biometrics/1.0/biometrics.xsd**Special Characters:** *n/a***Maximum Length:** 126**Maximum Occurrences:** 1**Regular Expression:** *n/a***Namespace:** <http://niem.gov/niem/biometrics/1.0>

Dependency table

Type of dependency	Value
Optional on Presence of other Field	9/ROI

XPath

```

/it1:PackageMinutiaeRecord
  ↙/biom:ExtendedFeatureSetMinutiae
    ↙/biom:MinutiaeCommentText

```

Summary

Additional information not noted in other fields. This may include unformatted text information such as location, background information, or descriptive information. If comments need to be made about specific portions of the impression, use Field 9.324 or Field 9.332.

Valid Examples

```
<biom:MinutiaeCommentText>Comment</biom:MinutiaeCommentText>
```

10.198. EFS Latent Processing Method - LPM

Field Reference: 9/LPM	Field ID: [09.352]
Content Type: Data	Condition: Dependent (see table)
XML Tag Name: LatentProcessingCategoryCode	Defined in: xsd/niem/biometrics/1.0/biometrics.xsd
Data Type: AN	Special Characters: <i>n/a</i>
Minimum Length: 3	Maximum Length: 3
Minimum Occurrences: 0	Maximum Occurrences: 9
Value range: <i>n/a</i>	Regular Expression: <i>n/a</i>
Code table: see table A.33	
Base type: biom:LatentProcessingCategoryCodeType	Namespace: http://niem.gov/niem/biometrics/1.0

Dependency table

Type of dependency	Value
Optional on Presence of other Field	9/ROI

XPath

```
/it1:PackageMinutiaeRecord
  ↙/biom:ExtendedFeatureSetMinutiae
    ↙/biom:LatentProcessingCategoryCode
```

Summary

Technique(s) used to process the latent fingerprint (only used for latent images). Unprocessed impressions (latent images visible to the naked eye) shall be labeled VIS. Methods should only be marked if they contributed substantively to the visualization of the image, and shall not be a compilation of all methods attempted.

Valid Examples

<biom:LatentProcessingCategoryCode>AMB</biom:LatentProcessingCategoryCode>
--

10.199. EFS Examiner Analysis Assessment - EAA

Field Reference: 9/EAA	Field ID: [09.353]
Content Type: Set	Condition: Dependent (see table)
XML Tag Name: MinutiaeValueAssessment	Defined in: xsd/niem/biometrics/1.0/biometrics.xsd
Data Type:	Special Characters: <i>n/a</i>
Minimum Length:	Maximum Length:
Minimum Occurrences: 0	Maximum Occurrences: 1
Value range: <i>n/a</i>	Regular Expression: <i>n/a</i>
Code table: <i>n/a</i>	
Base type: biom:MinutiaeValueAssessmentType	Namespace: http://niem.gov/niem/biometrics/1.0

Dependency table

Type of dependency	Value
Optional on Presence of other Field	9/ROI

XPath

```

/it1:PackageMinutiaeRecord
└─/biom:ExtendedFeatureSetMinutiae
  └─/biom:MinutiaeValueAssessment
    
```

Summary

Examiner's assessment of impression value.

10.200. Value Assessment Code - AAV

Field Reference: 9/EAA/AAV

Content Type: Data

XML Tag Name: MinutiaeValueAssessmentResultCode

Data Type: A

Minimum Length: 5

Minimum Occurrences: 1

Value range: *n/a*

Code table: see table [A.18](#)

Base type: biom:MinutiaeValueAssessmentResultCodeType

Field ID: [09.353-A]

Condition: Mandatory within a field

Defined in: xsd/niem/biometrics/1.0/biometrics.xsd

Special Characters: *n/a*

Maximum Length: 8

Maximum Occurrences: 1

Regular Expression: *n/a*

Namespace: <http://niem.gov/niem/biometrics/1.0>

XPath

```
/it1:PackageMinutiaeRecord
├─/biom:ExtendedFeatureSetMinutiae
│  └─/biom:MinutiaeValueAssessment
│     └─/biom:MinutiaeValueAssessmentResultCode
```

Summary

Value of impression.

Valid Examples

```
<biom:MinutiaeValueAssessmentResultCode>NOVALUE</biom:MinutiaeValueAssessmentResultCode>
```

10.201. Minutiae Examiner (XML)

Field Reference: 9/EAA/ALN_9/EAA/AFN
Content Type: Set_X
XML Tag Name: PersonName
Data Type:
Minimum Length:
Minimum Occurrences: 1
Value range: *n/a*
Code table: *n/a*
Base type: nc:PersonNameType

Field ID: [09.353-B_09.353-C]
Condition: Mandatory within a field
Defined in: xsd/niem/niem-core/2.0/niem-core.xsd
Special Characters: *n/a*
Maximum Length:
Maximum Occurrences: 1
Regular Expression: *n/a*
Namespace: <http://niem.gov/niem/niem-core/2.0>

XPath

```
/it1:PackageMinutiaeRecord  
  ↳/biom:ExtendedFeatureSetMinutiae  
    ↳/biom:MinutiaeValueAssessment  
      ↳/biom:MinutiaeExaminer  
        ↳/nc:PersonName
```

Summary

Minutiae examiner name.

Notes

Applies to 9.353-B and 9.353-C

10.202. Examiner Last Name - ALN

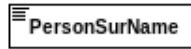

Field Reference: 9/EAA/ALN
Content Type: Data
XML Tag Name: PersonSurName
Data Type: U
Minimum Length: 1
Minimum Occurrences: 1
Value range: *n/a*
Code table: *n/a*
Base type: nc:PersonNameTextType

Field ID: [09.353-B]
Condition: Mandatory within a field
Defined in: xsd/niem/niem-core/2.0/niem-core.xsd
Special Characters: *n/a*
Maximum Length: 40
Maximum Occurrences: 1
Regular Expression: *n/a*

Namespace: <http://niem.gov/niem/niem-core/2.0>

XPath

```
/itl:PackageMinutiaeRecord  
  ↳/biom:ExtendedFeatureSetMinutiae  
    ↳/biom:MinutiaeValueAssessment  
      ↳/biom:MinutiaeExaminer  
        ↳/nc:PersonName  
          ↳/nc:PersonSurName
```

Summary

Last name of examiner.

Valid Examples

```
<nc:PersonSurName>Smith</nc:PersonSurName>
```

10.203. Examiner First Name - AFN

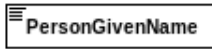

Field Reference: 9/EAA/AFN
Content Type: Data
XML Tag Name: PersonGivenName
Data Type: U
Minimum Length: 1
Minimum Occurrences: 1
Value range: *n/a*
Code table: *n/a*
Base type: nc:PersonNameTextType

Field ID: [09.353-C]
Condition: Mandatory within a field
Defined in: xsd/niem/niem-core/2.0/niem-core.xsd
Special Characters: *n/a*
Maximum Length: 40
Maximum Occurrences: 1
Regular Expression: *n/a*

Namespace: <http://niem.gov/niem/niem-core/2.0>

XPath

```
/itl:PackageMinutiaeRecord  
  ↳/biom:ExtendedFeatureSetMinutiae  
    ↳/biom:MinutiaeValueAssessment  
      ↳/biom:MinutiaeExaminer  
        ↳/nc:PersonName  
          ↳/nc:PersonGivenName
```

Summary

Given name or first and middle names of examiner.

Valid Examples

```
<nc:PersonGivenName>John</nc:PersonGivenName>
```

10.204. Examiner Affiliation - AAF

 OrganizationName

Field Reference: 9/EAA/AAF
Content Type: Data
XML Tag Name: OrganizationName
Data Type: U
Minimum Length: 1
Minimum Occurrences: 1
Value range: *n/a*
Code table: *n/a*
Base type: nc:TextType

Field ID: [09.353-D]
Condition: Mandatory within a field
Defined in: xsd/niem/niem-core/2.0/niem-core.xsd
Special Characters: *n/a*
Maximum Length: 99
Maximum Occurrences: 1
Regular Expression: *n/a*

Namespace: <http://niem.gov/niem/niem-core/2.0>

XPath

```
/itl:PackageMinutiaeRecord  
  ↳/biom:ExtendedFeatureSetMinutiae  
    ↳/biom:MinutiaeValueAssessment  
      ↳/biom:MinutiaeExaminerAffiliation  
        ↳/nc:OrganizationName
```

Summary

Employer or organizational affiliation of examiner.

Valid Examples

```
<nc:OrganizationName>FBI</nc:OrganizationName>
```

10.205. Date and Time (XML) - AMT



Field Reference: 9/EAA/AMT:X
Content Type: Data_X
XML Tag Name: DateTime
Data Type: ANS
Minimum Length: 20
Minimum Occurrences: 1
Value range: *n/a*
Code table: *n/a*
Base type: [niem-xsd:dateTime](#)

Field ID: [09.353-E:X]
Condition: Mandatory within a field
Defined in: [xsd/niem/niem-core/2.0/niem-core.xsd](#)
Special Characters: [-:]
Maximum Length: 20
Maximum Occurrences: 1
Regular Expression: \d{4}-\d{2}-\d{2}T\d{2}:\d{2}:\d{2}Z
Namespace: <http://niem.gov/niem/niem-core/2.0>

XPath

```
/itl:PackageMinutiaeRecord  
  ↳/biom:ExtendedFeatureSetMinutiae  
    ↳/biom:MinutiaeValueAssessment  
      ↳/biom:MinutiaeValueAssessmentDateTime  
        ↳/nc:DateTime
```

Summary

Date and time determination was made.

Valid Examples

```
<nc:DateTime>2007-01-01T00:00:01Z</nc:DateTime>
```

10.206. Comment - ACM

Field Reference: 9/EAA/ACM
Content Type: Data
XML Tag Name: MinutiaeCommentText
Data Type: U
Minimum Length: 1
Minimum Occurrences: 0
Value range: *n/a*
Code table: *n/a*
Base type: nc:TextType

Field ID: [09.353-F]
Condition: Optional within a field
Defined in: xsd/niem/biometrics/1.0/biometrics.xsd
Special Characters: *n/a*
Maximum Length: 200
Maximum Occurrences: 1
Regular Expression: *n/a*
Namespace: <http://niem.gov/niem/biometrics/1.0>

XPath

```
/it1:PackageMinutiaeRecord  
  ↳/biom:ExtendedFeatureSetMinutiae  
    ↳/biom:MinutiaeValueAssessment  
      ↳/biom:MinutiaeCommentText
```

Summary

Additional clarifying information for examiner analysis assessment.

Valid Examples

```
<biom:MinutiaeCommentText>Low minutiae count</biom:MinutiaeCommentText>
```

10.207. Analysis Complexity Flag - CXF

Field Reference: 9/EAA/CXF
Content Type: Data
XML Tag Name: MinutiaeAnalysisComplexityCode
Data Type: A
Minimum Length: 7
Minimum Occurrences: 0
Value range: {"COMPLEX"}
Code table: *n/a*
Base type: biom:MinutiaeAnalysisComplexityCodeType

Field ID: [09.353-G]
Condition: Optional within a field
Defined in: xsd/niem/biometrics/1.0/biometrics.xsd
Special Characters: *n/a*
Maximum Length: 7
Maximum Occurrences: 1
Regular Expression: *n/a*
Namespace: <http://niem.gov/niem/biometrics/1.0>

XPath

```
/it1:PackageMinutiaeRecord  
  ↳/biom:ExtendedFeatureSetMinutiae  
    ↳/biom:MinutiaeValueAssessment  
      ↳/biom:MinutiaeAnalysisComplexityCode
```

Summary

Indicates the examiner determined that the analysis was complex as defined in Standards for examining friction ridge impressions and resulting conclusions.

Valid Examples

```
<biom:MinutiaeAnalysisComplexityCode>COMPLEX</biom:MinutiaeAnalysisComplexityCode>
```

10.208. EFS Evidence of Fraud - EOF

Field Reference: 9/EOF

Content Type: Set

XML Tag Name: MinutiaeFraudEvidence

Data Type:

Minimum Length:

Minimum Occurrences: 0

Value range: *n/a*

Code table: *n/a*

Base type: biom:MinutiaeFraudEvidenceType

Field ID: [09.354]

Condition: Dependent (see table)

Defined in: xsd/niem/biometrics/1.0/biometrics.xsd

Special Characters: *n/a*

Maximum Length:

Maximum Occurrences: 4

Regular Expression: *n/a*

Namespace: <http://niem.gov/niem/biometrics/1.0>

Dependency table

Type of dependency	Value
Optional on Presence of other Field	9/ROI

XPath

```
/itl:PackageMinutiaeRecord
  ↳/biom:ExtendedFeatureSetMinutiae
    ↳/biom:MinutiaeFraudEvidence
```

Summary

Indicates that the image may be fraudulent.

10.209. Fraud Type - FRA

Field Reference: 9/EOF/FRA

Content Type: Data

XML Tag Name: MinutiaeFraudEvidenceCategoryCode

Data Type: A

Minimum Length: 3

Minimum Occurrences: 1

Value range: *n/a*

Code table: see table [A.21](#)

Base type: biom:MinutiaeFraudEvidenceCategoryCodeType

Field ID: [09.354-A]

Condition: Mandatory within a field

Defined in: xsd/niem/biometrics/1.0/biometrics.xsd

Special Characters: *n/a*

Maximum Length: 3

Maximum Occurrences: 1

Regular Expression: *n/a*

Namespace: <http://niem.gov/niem/biometrics/1.0>

XPath

```
/it1:PackageMinutiaeRecord
  ↙/biom:ExtendedFeatureSetMinutiae
    ↙/biom:MinutiaeFraudEvidence
      ↙/biom:MinutiaeFraudEvidenceCategoryCode
```

Summary

Potential type of fraud attempted.

Valid Examples

```
<biom:MinutiaeFraudEvidenceCategoryCode>EVA</biom:MinutiaeFraudEvidenceCategoryCode>
```

10.210. Comment - CFD

Field Reference: 9/EOF/CFD
Content Type: Data
XML Tag Name: MinutiaeCommentText
Data Type: U
Minimum Length: 1
Minimum Occurrences: 0
Value range: *n/a*
Code table: *n/a*
Base type: nc:TextType

Field ID: [09.354-B]
Condition: Optional within a field
Defined in: xsd/niem/biometrics/1.0/biometrics.xsd
Special Characters: *n/a*
Maximum Length: 200
Maximum Occurrences: 1
Regular Expression: *n/a*
Namespace: <http://niem.gov/niem/biometrics/1.0>

XPath

```
/itl:PackageMinutiaeRecord  
  ↳/biom:ExtendedFeatureSetMinutiae  
    ↳/biom:MinutiaeFraudEvidence  
      ↳/biom:MinutiaeCommentText
```

Summary

Clarifying information regarding assessment of potential evidence of fraud.

Valid Examples

```
<biom:MinutiaeCommentText>Fake fingerprints</biom:MinutiaeCommentText>
```

10.211. EFS Latent Substrate - LSB

Field Reference: 9/LSB

Content Type: Set

XML Tag Name: MinutiaeLatentSubstrate

Data Type:

Minimum Length:

Minimum Occurrences: 0

Value range: *n/a*

Code table: *n/a*

Base type: biom:MinutiaeLatentSubstrateType

Field ID: [09.355]

Condition: Dependent (see table)

Defined in: xsd/niem/biometrics/1.0/biometrics.xsd

Special Characters: *n/a*

Maximum Length:

Maximum Occurrences: 3

Regular Expression: *n/a*

Namespace: <http://niem.gov/niem/biometrics/1.0>

Dependency table

Type of dependency	Value
Optional on Presence of other Field	9/ROI

XPath

```
/itl:PackageMinutiaeRecord
  ↳/biom:ExtendedFeatureSetMinutiae
    ↳/biom:MinutiaeLatentSubstrate
```

Summary

EFS surface on which the friction ridge impression was deposited. If multiple substrates are present, they are represented by separate subfields.

10.212. Code - CLS

Field Reference: 9/LSB/CLS	Field ID: [09.355-A]
Content Type: Data	Condition: Mandatory within a field
XML Tag Name: MinutiaeLatentSubstrateCategoryCode	Defined in: xsd/niem/biometrics/1.0/biometrics.xsd
Data Type: AN	Special Characters: <i>n/a</i>
Minimum Length: 1	Maximum Length: 2
Minimum Occurrences: 1	Maximum Occurrences: 1
Value range: <i>n/a</i>	Regular Expression: <i>n/a</i>
Code table: see table A.35	
Base type: biom:MinutiaeLatentSubstrateCategoryCodeType	Namespace: http://niem.gov/niem/biometrics/1.0

XPath

```

/itl:PackageMinutiaeRecord
├─/biom:ExtendedFeatureSetMinutiae
│   └─/biom:MinutiaeLatentSubstrate
│       └─/biom:MinutiaeLatentSubstrateCategoryCode

```

Summary

Type of substrate.

Valid Examples

```
<biom:MinutiaeLatentSubstrateCategoryCode>3D</biom:MinutiaeLatentSubstrateCategoryCode>
```

10.213. Object/Substrate Description - OSD

Field Reference: 9/LSB/OSD	Field ID: [09.355-B]
Content Type: Data	Condition: Optional within a field
XML Tag Name: MinutiaeLatentSubstrateDescriptionText	Defined in: xsd/niem/biometrics/1.0/biometrics.xsd
Data Type: U	Special Characters: <i>n/a</i>
Minimum Length: 1	Maximum Length: 1000
Minimum Occurrences: 0	Maximum Occurrences: 1
Value range: <i>n/a</i>	Regular Expression: <i>n/a</i>
Code table: <i>n/a</i>	
Base type: nc:TextType	Namespace: http://niem.gov/niem/biometrics/1.0

XPath

```
/it1:PackageMinutiaeRecord  
  ↘/biom:ExtendedFeatureSetMinutiae  
    ↘/biom:MinutiaeLatentSubstrate  
      ↘/biom:MinutiaeLatentSubstrateDescriptionText
```

Summary

Text that describes object or surface on which print was deposited, or provides clarifying information regarding the substrate.

Valid Examples

```
<biom:MinutiaeLatentSubstrateDescriptionText>Glass</biom:MinutiaeLatentSubstrateDescriptionText>
```

10.214. EFS Latent Matrix - LMT

Field Reference: 9/LMT

Content Type: Set

XML Tag Name: MinutiaeLatentMatrix

Data Type:

Minimum Length:

Minimum Occurrences: 0

Value range: *n/a*

Code table: *n/a*

Base type: biom:MinutiaeLatentMatrixType

Field ID: [09.356]

Condition: Dependent (see table)

Defined in: xsd/niem/biometrics/1.0/biometrics.xsd

Special Characters: *n/a*

Maximum Length:

Maximum Occurrences: 3

Regular Expression: *n/a*

Namespace: <http://niem.gov/niem/biometrics/1.0>

Dependency table

Type of dependency	Value
Optional on Presence of other Field	9/ROI

XPath

```
/itl:PackageMinutiaeRecord
  ↙/biom:ExtendedFeatureSetMinutiae
    ↙/biom:MinutiaeLatentMatrix
```

Summary

EFS substance deposited by the finger that forms the impression. Each latent matrix is represented by a repeating subfield.

10.215. Code - TOM

Field Reference: 9/LMT/TOM

Content Type: Data

XML Tag Name: MinutiaeLatentMatrixCategoryCode

Data Type: N

Minimum Length: 1

Minimum Occurrences: 1

Value range: *n/a*

Code table: see table [A.32](#)

Base type: biom:MinutiaeLatentMatrixCategoryCodeType

Field ID: [09.356-A]

Condition: Mandatory within a field

Defined in: xsd/niem/biometrics/1.0/biometrics.xsd

Special Characters: *n/a*

Maximum Length: 2

Maximum Occurrences: 1

Regular Expression: *n/a*

Namespace: <http://niem.gov/niem/biometrics/1.0>

XPath

```
/itl:PackageMinutiaeRecord
  ↳/biom:ExtendedFeatureSetMinutiae
    ↳/biom:MinutiaeLatentMatrix
      ↳/biom:MinutiaeLatentMatrixCategoryCode
```

Summary

Type of substance deposited by finger. All visible contaminants are apparent rather than necessarily known to certainty: for example, the substrate may be marked as blood if it appears to be blood; if known for certain that should be indicated as a comment.

Valid Examples

```
<biom:MinutiaeLatentMatrixCategoryCode>1</biom:MinutiaeLatentMatrixCategoryCode>
```

10.216. Comment - CLA

Field Reference: 9/LMT/CLA
Content Type: Data
XML Tag Name: MinutiaeCommentText
Data Type: U
Minimum Length: 1
Minimum Occurrences: 0
Value range: *n/a*
Code table: *n/a*
Base type: nc:TextType

Field ID: [09.356-B]
Condition: Optional within a field
Defined in: xsd/niem/biometrics/1.0/biometrics.xsd
Special Characters: *n/a*
Maximum Length: 1000
Maximum Occurrences: 1
Regular Expression: *n/a*
Namespace: <http://niem.gov/niem/biometrics/1.0>

XPath

```
/it1:PackageMinutiaeRecord  
  ↳/biom:ExtendedFeatureSetMinutiae  
    ↳/biom:MinutiaeLatentMatrix  
      ↳/biom:MinutiaeCommentText
```

Summary

Clarifying information regarding the deposited substance.

Valid Examples

```
<biom:MinutiaeCommentText>Known for certain that substrate is perspiration</biom:MinutiaeCommentText>
```

10.217. EFS Local Quality Issues - LQI

Field Reference: 9/LQI	Field ID: [09.357]
Content Type: Set	Condition: Dependent (see table)
XML Tag Name: MinutiaeLocalQualityIssues	Defined in: xsd/niem/biometrics/1.0/biometrics.xsd
Data Type:	Special Characters: <i>n/a</i>
Minimum Length:	Maximum Length:
Minimum Occurrences: 0	Maximum Occurrences: *
Value range: <i>n/a</i>	Regular Expression: <i>n/a</i>
Code table: <i>n/a</i>	
Base type: biom:MinutiaeLocalQualityIssuesType	Namespace: http://niem.gov/niem/biometrics/1.0

Dependency table

Type of dependency	Value
Optional on Presence of other Field	9/ROI

XPath

```

/it1:PackageMinutiaeRecord
  ↙/biom:ExtendedFeatureSetMinutiae
    ↙/biom:MinutiaeLocalQualityIssues
    
```

Summary

Defines area(s) containing quality or transfer issues that indicate that the anatomical friction ridge features may not have been accurately represented in the image.

10.218. Type - LQT

Field Reference: 9/LQI/LQT

Content Type: Data

XML Tag Name: MinutiaeLocalQualityIssuesCategoryCode

Data Type: A

Minimum Length: 4

Minimum Occurrences: 1

Value range: *n/a*

Code table: see table [A.34](#)

Base type: biom:MinutiaeLocalQualityIssuesCategoryCodeType

Field ID: [09.357-A]

Condition: Mandatory within a field

Defined in: [xsd/niem/biometrics/1.0/biometrics.xsd](#)

Special Characters: *n/a*

Maximum Length: 10

Maximum Occurrences: 1

Regular Expression: *n/a*

Namespace: <http://niem.gov/niem/biometrics/1.0>

XPath

```
/it1:PackageMinutiaeRecord
  ↳/biom:ExtendedFeatureSetMinutiae
    ↳/biom:MinutiaeLocalQualityIssues
      ↳/biom:MinutiaeLocalQualityIssuesCategoryCode
```

Summary

Type of quality issue.

Valid Examples

```
<biom:MinutiaeLocalQualityIssuesCategoryCode>BACKGROUND</biom:MinutiaeLocalQualityIssuesCategoryCode>
```

10.219. Image Segment Polygon (XML) - LQP

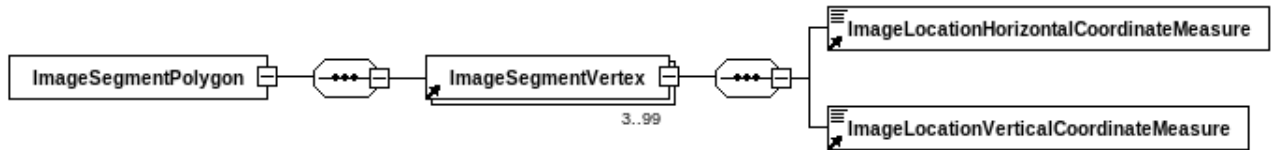

Field Reference: 9/LQI/LQP:X1
Content Type: Set_X
XML Tag Name: ImageSegmentPolygon
Data Type:
Minimum Length:
Minimum Occurrences: 1
Value range: *n/a*
Code table: *n/a*
Base type: biom:ImageSegmentPolygonType

Field ID: [09.357-B:X1]
Condition: Mandatory within a field
Defined in: xsd/niem/biometrics/1.0/biometrics.xsd
Special Characters: *n/a*
Maximum Length:
Maximum Occurrences: 1
Regular Expression: *n/a*
Namespace: <http://niem.gov/niem/biometrics/1.0>

XPath

```

/itl:PackageMinutiaeRecord
└─/biom:ExtendedFeatureSetMinutiae
  └─/biom:MinutiaeLocalQualityIssues
    └─/biom:ImageSegmentPolygon
  
```

Summary

Closed path polygon outlining the area of the quality issue.

10.220. Image Segment Vertex (XML) - LQP

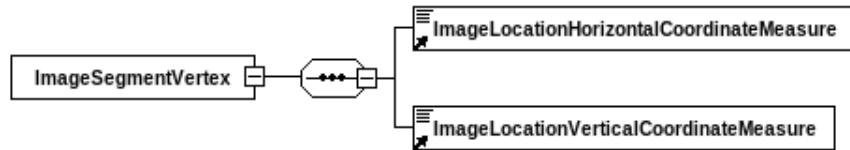

Field Reference: 9/LQI/LQP:X2
Content Type: Set_X
XML Tag Name: ImageSegmentVertex
Data Type:
Minimum Length:
Minimum Occurrences: 3
Value range: *n/a*
Code table: *n/a*
Base type: biom:ImageSegmentVertexType

Field ID: [09.357-B:X2]
Condition: Mandatory within a field
Defined in: xsd/niem/biometrics/1.0/biometrics.xsd
Special Characters: *n/a*
Maximum Length:
Maximum Occurrences: 99
Regular Expression: *n/a*
Namespace: <http://niem.gov/niem/biometrics/1.0>

XPath

```
/itl:PackageMinutiaeRecord
  ↳/biom:ExtendedFeatureSetMinutiae
    ↳/biom:MinutiaeLocalQualityIssues
      ↳/biom:ImageSegmentPolygon
        ↳/biom:ImageSegmentVertex
```

Summary

Closed path polygon outlining the area of the quality issue.

10.221. Image Location Horizontal Coordinate Measure (XML) - LQP

ImageLocationHorizontalCoordinateMeasure

Field Reference: 9/LQI/LQP:X3

Content Type: Data_NX-1T

XML Tag Name: ImageLocationHorizontalCoordinateMeasure

Data Type: N

Minimum Length: 1

Minimum Occurrences: 1

Value range: {0..49999}

Code table: *n/a*

Base type: niem-xsd:integer

Field ID: [09.357-B:X3]

Condition: Mandatory within a field

Defined in: xsd/niem/biometrics/1.0/biometrics.xsd

Special Characters: *n/a*

Maximum Length: 5

Maximum Occurrences: 1

Regular Expression: *n/a*

Namespace: <http://niem.gov/niem/biometrics/1.0>

XPath

```

/itl:PackageMinutiaeRecord
├─/biom:ExtendedFeatureSetMinutiae
│   └─/biom:MinutiaeLocalQualityIssues
│       └─/biom:ImageSegmentPolygon
│           └─/biom:ImageSegmentVertex
│               └─/biom:ImageLocationHorizontalCoordinateMeasure

```

Summary

Closed path polygon outlining the area of the quality issue.

Valid Examples

<code><biom:ImageLocationHorizontalCoordinateMeasure>1530</biom:ImageLocationHorizontalCoordinateMeasure></code>
--

10.222. Image Location Vertical Coordinate Measure (XML) - LQP

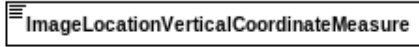

Field Reference: 9/LQI/LQP:X4

Content Type: Data_NX-1T

XML Tag Name: ImageLocationVerticalCoordinateMeasure

Data Type: N

Minimum Length: 1

Minimum Occurrences: 1

Value range: {0..49999}

Code table: *n/a*

Base type: niem-xsd:integer

Field ID: [09.357-B:X4]

Condition: Mandatory within a field

Defined in: xsd/niem/biometrics/1.0/biometrics.xsd

Special Characters: *n/a*

Maximum Length: 5

Maximum Occurrences: 1

Regular Expression: *n/a*

Namespace: <http://niem.gov/niem/biometrics/1.0>

XPath

```
/itl:PackageMinutiaeRecord
├─/biom:ExtendedFeatureSetMinutiae
│   └─/biom:MinutiaeLocalQualityIssues
│       └─/biom:ImageSegmentPolygon
│           └─/biom:ImageSegmentVertex
│               └─/biom:ImageLocationVerticalCoordinateMeasure
```

Summary

Closed path polygon outlining the area of the quality issue.

Valid Examples

```
<biom:ImageLocationVerticalCoordinateMeasure>2510</biom:ImageLocationVerticalCoordinateMeasure>
```

10.223. Comment - LQC

Field Reference: 9/LQI/LQC
Content Type: Data
XML Tag Name: MinutiaeCommentText
Data Type: U
Minimum Length: 1
Minimum Occurrences: 0
Value range: *n/a*
Code table: *n/a*
Base type: nc:TextType

Field ID: [09.357-C]
Condition: Optional within a field
Defined in: xsd/niem/biometrics/1.0/biometrics.xsd
Special Characters: *n/a*
Maximum Length: 1000
Maximum Occurrences: 1
Regular Expression: *n/a*
Namespace: <http://niem.gov/niem/biometrics/1.0>

XPath

```
/itl:PackageMinutiaeRecord  
  ↪/biom:ExtendedFeatureSetMinutiae  
    ↪/biom:MinutiaeLocalQualityIssues  
      ↪/biom:MinutiaeCommentText
```

Summary

Text describing quality issue.

10.224. EFS Area of Correspondence - AOC

Field Reference: 9/AOC	Field ID: [09.360]
Content Type: Set	Condition: Dependent (see table)
XML Tag Name: FrictionRidgeImageAreaOfCorrespondence	Defined in: xsd/niem/biometrics/1.0/biometrics.xsd
Data Type:	Special Characters: <i>n/a</i>
Minimum Length:	Maximum Length:
Minimum Occurrences: 0	Maximum Occurrences: *
Value range: <i>n/a</i>	Regular Expression: <i>n/a</i>
Code table: <i>n/a</i>	
Base type: biom:FrictionRidgeImageAreaOfCorrespondenceType	Namespace: http://niem.gov/niem/biometrics/1.0

Dependency table

Type of dependency	Value
Optional on Presence of other Field	9/ROI

XPath

```
/it1:PackageMinutiaeRecord
└─/biom:ExtendedFeatureSetMinutiae
  └─/biom:FrictionRidgeImageAreaOfCorrespondence
```

Summary

EFS polygon enclosing a region of usable ridge detail in two or more images being compared. If the corresponding areas are discontinuous, more than one area of correspondence may be defined for a pair of images, each in a separate subfield.

Notes

Note that the AOC in a given Type-9 record contains an IDC reference for one or more other Type-9 record in a transaction. For example, a latent could have areas of correspondence with both the rolled and plain exemplars from one subject, or a latent could have areas of correspondence with candidate exemplars from two different subjects. If two prints overlap but neither encloses the area of the other (such as shown in Figure 11, the AOC shall be marked for both prints. If the area of a small print is completely enclosed by the area of a larger print so that the AOC for the small print is identical to the ROI, the AOC may be omitted for the smaller print.

10.225. IDC Reference - CIR



Field Reference: 9/AOC/CIR
Content Type: Data
XML Tag Name: IdentificationID
Data Type: N
Minimum Length: 1
Minimum Occurrences: 1
Value range: {0..99}
Code table: *n/a*
Base type: niem-xsd:string

Field ID: [09.360-A]
Condition: Mandatory within a field
Defined in: xsd/niem/niem-core/2.0/niem-core.xsd
Special Characters: *n/a*
Maximum Length: 2
Maximum Occurrences: 1
Regular Expression: *n/a*

Namespace: <http://niem.gov/niem/niem-core/2.0>

XPath

```
/itl:PackageMinutiaeRecord
  ↳/biom:ExtendedFeatureSetMinutiae
    ↳/biom:FrictionRidgeImageAreaOfCorrespondence
      ↳/biom:ImageReferenceIdentification
        ↳/nc:IdentificationID
```

Summary

IDC for the target image / Type-9 record for a given AOC.

Valid Examples

```
<nc:IdentificationID>2</nc:IdentificationID>
```

10.226. Image Segment Polygon (XML) - AOP

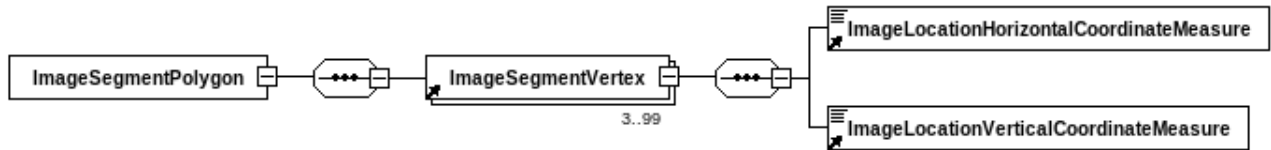

Field Reference: 9/AOC/AOP:X1
Content Type: Set_X
XML Tag Name: ImageSegmentPolygon
Data Type:
Minimum Length:
Minimum Occurrences: 1
Value range: *n/a*
Code table: *n/a*
Base type: biom:ImageSegmentPolygonType

Field ID: [09.360-B:X1]
Condition: Mandatory within a field
Defined in: xsd/niem/biometrics/1.0/biometrics.xsd
Special Characters: *n/a*
Maximum Length:
Maximum Occurrences: 1
Regular Expression: *n/a*
Namespace: <http://niem.gov/niem/biometrics/1.0>

XPath

```

/itl:PackageMinutiaeRecord
  ↙/biom:ExtendedFeatureSetMinutiae
    ↙/biom:FrictionRidgeImageAreaOfCorrespondence
      ↙/biom:ImageSegmentPolygon
  
```

Summary

Defines outline of corresponding area.

10.227. Image Segment Vertex (XML) - AOP

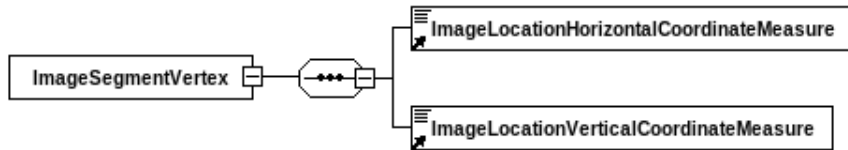

Field Reference: 9/AOC/AOP:X2
Content Type: Set_X
XML Tag Name: ImageSegmentVertex
Data Type:
Minimum Length:
Minimum Occurrences: 3
Value range: *n/a*
Code table: *n/a*
Base type: biom:ImageSegmentVertexType

Field ID: [09.360-B:X2]
Condition: Mandatory within a field
Defined in: xsd/niem/biometrics/1.0/biometrics.xsd
Special Characters: *n/a*
Maximum Length:
Maximum Occurrences: 99
Regular Expression: *n/a*
Namespace: <http://niem.gov/niem/biometrics/1.0>

XPath

```

/itl:PackageMinutiaeRecord
  ↳/biom:ExtendedFeatureSetMinutiae
    ↳/biom:FrictionRidgeImageAreaOfCorrespondence
      ↳/biom:ImageSegmentPolygon
        ↳/biom:ImageSegmentVertex
    
```

Summary

Defines outline of corresponding area.

10.228. Image Location Horizontal Coordinate Measure (XML) - AOP

 ImageLocationHorizontalCoordinateMeasure

Field Reference: 9/AOC/AOP:X3

Content Type: Data_NX-1T

XML Tag Name: ImageLocationHorizontalCoordinateMeasure

Data Type: N

Minimum Length: 1

Minimum Occurrences: 1

Value range: {0..49999}

Code table: *n/a*

Base type: niem-xsd:integer

Field ID: [09.360-B:X3]

Condition: Mandatory within a field

Defined in: xsd/niem/biometrics/1.0/biometrics.xsd

Special Characters: *n/a*

Maximum Length: 5

Maximum Occurrences: 1

Regular Expression: *n/a*

Namespace: <http://niem.gov/niem/biometrics/1.0>

XPath

```
/itl:PackageMinutiaeRecord
  ↳/biom:ExtendedFeatureSetMinutiae
    ↳/biom:FrictionRidgeImageAreaOfCorrespondence
      ↳/biom:ImageSegmentPolygon
        ↳/biom:ImageSegmentVertex
          ↳/biom:ImageLocationHorizontalCoordinateMeasure
```

Summary

Defines outline of corresponding area.

Valid Examples

```
<biom:ImageLocationHorizontalCoordinateMeasure>1530</biom:ImageLocationHorizontalCoordinateMeasure>
```

10.229. Image Location Vertical Coordinate Measure (XML) - AOP

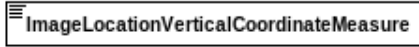

Field Reference: 9/AOC/AOP:X4

Content Type: Data_NX-1T

XML Tag Name: ImageLocationVerticalCoordinateMeasure

Data Type: N

Minimum Length: 1

Minimum Occurrences: 1

Value range: {0..49999}

Code table: *n/a*

Base type: niem-xsd:integer

Field ID: [09.360-B:X4]

Condition: Mandatory within a field

Defined in: xsd/niem/biometrics/1.0/biometrics.xsd

Special Characters: *n/a*

Maximum Length: 5

Maximum Occurrences: 1

Regular Expression: *n/a*

Namespace: <http://niem.gov/niem/biometrics/1.0>

XPath

```
/itl:PackageMinutiaeRecord
├── /biom:ExtendedFeatureSetMinutiae
│   ├── /biom:FrictionRidgeImageAreaOfCorrespondence
│   │   ├── /biom:ImageSegmentPolygon
│   │   │   ├── /biom:ImageSegmentVertex
│   │   │   └── /biom:ImageLocationVerticalCoordinateMeasure
```

Summary

Defines outline of corresponding area.

Valid Examples

```
<biom:ImageLocationVerticalCoordinateMeasure>2510</biom:ImageLocationVerticalCoordinateMeasure>
```

10.230. Comment - CAC

Field Reference: 9/AOC/CAC
Content Type: Data
XML Tag Name: MinutiaeCommentText
Data Type: U
Minimum Length: 1
Minimum Occurrences: 0
Value range: *n/a*
Code table: *n/a*
Base type: nc:TextType

Field ID: [09.360-C]
Condition: Optional within a field
Defined in: xsd/niem/biometrics/1.0/biometrics.xsd
Special Characters: *n/a*
Maximum Length: 1000
Maximum Occurrences: 1
Regular Expression: *n/a*
Namespace: <http://niem.gov/niem/biometrics/1.0>

XPath

```
/itl:PackageMinutiaeRecord  
  ↳/biom:ExtendedFeatureSetMinutiae  
    ↳/biom:FrictionRidgeImageAreaOfCorrespondence  
      ↳/biom:MinutiaeCommentText
```

Summary

Free text comment or description related to the AOC.

10.231. EFS Corresponding Points or Features - CPF

Field Reference: 9/CPF	Field ID: [09.361]
Content Type: Set	Condition: Dependent (see table)
XML Tag Name: MinutiaeFeatureCorrespondence	Defined in: xsd/niem/biometrics/1.0/biometrics.xsd
Data Type:	Special Characters: <i>n/a</i>
Minimum Length:	Maximum Length:
Minimum Occurrences: 0	Maximum Occurrences: *
Value range: <i>n/a</i>	Regular Expression: <i>n/a</i>
Code table: <i>n/a</i>	
Base type: biom:MinutiaeFeatureCorrespondenceType	Namespace: http://niem.gov/niem/biometrics/1.0

Dependency table

Type of dependency	Value
Optional on Presence of other Field	9/ROI

XPath

```

/it1:PackageMinutiaeRecord
  ↳/biom:ExtendedFeatureSetMinutiae
    ↳/biom:MinutiaeFeatureCorrespondence
    
```

Summary

EFS points and features for corresponding areas.

10.232. Label - COL

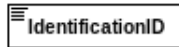

Field Reference: 9/CPF/COL
Content Type: Data
XML Tag Name: IdentificationID
Data Type: AN
Minimum Length: 1
Minimum Occurrences: 1
Value range: *n/a*
Code table: *n/a*
Base type: niem-xsd:string

Field ID: [09.361-A]
Condition: Mandatory within a field
Defined in: xsd/niem/niem-core/2.0/niem-core.xsd
Special Characters: *n/a*
Maximum Length: 3
Maximum Occurrences: 1
Regular Expression: *n/a*

Namespace: <http://niem.gov/niem/niem-core/2.0>

XPath

```

/itl:PackageMinutiaeRecord
  ↳/biom:ExtendedFeatureSetMinutiae
    ↳/biom:MinutiaeFeatureCorrespondence
      ↳/biom:MinutiaeFeatureIdentification
        ↳/nc:IdentificationID
  
```

Summary

Alphanumeric label used to indicate corresponding features and points in different Type-9 records. The label names may be selected and assigned at the discretion of the system or the examiner.

Notes

Labels within a single Type-9 record shall be unique. Note that the use of a given label in one Type-9 record means that that point or feature corresponds with any or all other features with the same label in other Type-9 records in the transaction.

Valid Examples

```
<nc:IdentificationID>3</nc:IdentificationID>
```

10.233. Type of Correspondence - TOC

Field Reference: 9/CPF/TOC	Field ID: [09.361-B]
Content Type: Data	Condition: Mandatory within a field
XML Tag Name: MinutiaeFeatureCorrespondenceCategoryCode	Defined in: xsd/niem/biometrics/1.0/biometrics.xsd
Data Type: A	Special Characters: n/a
Minimum Length: 1	Maximum Length: 2
Minimum Occurrences: 1	Maximum Occurrences: 1
Value range: n/a	Regular Expression: n/a
Code table: see table A.10	
Base type: biom:MinutiaeFeatureCorrespondenceCategoryCodeType	Namespace: http://niem.gov/niem/biometrics/1.0

XPath

```

/it1:PackageMinutiaeRecord
├─/biom:ExtendedFeatureSetMinutiae
│   └─/biom:MinutiaeFeatureCorrespondence
│       └─/biom:MinutiaeFeatureCorrespondenceCategoryCode
    
```

Summary

Code indicating the type of correspondence or non-correspondence.

Valid Examples

```
<biom:MinutiaeFeatureCorrespondenceCategoryCode>R</biom:MinutiaeFeatureCorrespondenceCategoryCode>
```

10.234. Corresponding Field Number - CFN

Field Reference: 9/CPF/CFN	Field ID: [09.361-C]
Content Type: Data	Condition: ?
XML Tag Name: MinutiaeFeatureCategoryCode	Defined in: xsd/niem/biometrics/1.0/biometrics.xsd
Data Type: N	Special Characters: <i>n/a</i>
Minimum Length: 3	Maximum Length: 3
Minimum Occurrences: 0	Maximum Occurrences: 1
Value range: <i>n/a</i>	Regular Expression: <i>n/a</i>
Code table: see table A.9	
Base type: biom:MinutiaeFeatureCategoryCodeType	Namespace: http://niem.gov/niem/biometrics/1.0

Dependency table

Type of dependency	Value
Mandatory on Value of other Field, should not be set if not.	[9/CPF/TOC]IN{"F","DF"}

XPath

```

/it1:PackageMinutiaeRecord
  ↳/biom:ExtendedFeatureSetMinutiae
    ↳/biom:MinutiaeFeatureCorrespondence
      ↳/biom:MinutiaeFeatureCategoryCode
    
```

Summary

Field number being compared.

Valid Examples

```
<biom:MinutiaeFeatureCategoryCode>331</biom:MinutiaeFeatureCategoryCode>
```

10.235. Corresponding Field Occurrence - FOC

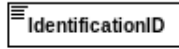

Field Reference: 9/CPF/FOC
Content Type: Data
XML Tag Name: IdentificationID
Data Type: N
Minimum Length: 1
Minimum Occurrences: 0
Value range: {1..999}
Code table: *n/a*
Base type: niem-xsd:string

Field ID: [09.361-D]
Condition: ?
Defined in: xsd/niem/niem-core/2.0/niem-core.xsd
Special Characters: *n/a*
Maximum Length: 3
Maximum Occurrences: 1
Regular Expression: *n/a*

Namespace: <http://niem.gov/niem/niem-core/2.0>

Dependency table

Type of dependency	Value
Mandatory on Value of other Field, should not be set if not.	[9/CPF/TOC]IN{"F","DF"}

XPath

```

/itl:PackageMinutiaeRecord
├─/biom:ExtendedFeatureSetMinutiae
│   └─/biom:MinutiaeFeatureCorrespondence
│       └─/biom:MinutiaeFeatureReferenceIdentification
│           └─/nc:IdentificationID
    
```

Summary

Occurrence of the specified field that the label applies to. Occurrences are numbered starting with 1.

Valid Examples

```
<nc:IdentificationID>11</nc:IdentificationID>
```

10.236. Corresponding X Coordinate - CXC

ImageLocationHorizontalCoordinateMeasure

<p>Field Reference: 9/CPF/CXC Content Type: Data XML Tag Name: ImageLocationHorizontalCoordinateMeasure Data Type: N Minimum Length: 1 Minimum Occurrences: 0 Value range: <i>n/a</i> Code table: <i>n/a</i> Base type: niem-xsd:integer</p>	<p>Field ID: [09.361-E] Condition: ? Defined in: xsd/niem/biometrics/1.0/biometrics.xsd Special Characters: <i>n/a</i> Maximum Length: 5 Maximum Occurrences: 1 Regular Expression: <i>n/a</i> Namespace: http://niem.gov/niem/biometrics/1.0</p>
---	--

Dependency table	
Type of dependency	Value
Mandatory on Value of other Field, optional otherwise.	[9/CPF/TOC]IN{"P","DP"}
Optional on Value of other Field, should not be set otherwise.	[9/CPF/TOC]="X"

XPath

```

/it1:PackageMinutiaeRecord
└─/biom:ExtendedFeatureSetMinutiae
   └─/biom:MinutiaeFeatureCorrespondence
      └─/biom:ImageLocationHorizontalCoordinateMeasure
    
```

Summary

X coordinate of feature/point (units of 10 micrometers).

Valid Examples

```

<biom:ImageLocationHorizontalCoordinateMeasure>9880</biom:ImageLocationHorizontalCoordinateMeasure>
    
```

10.237. Corresponding Y Coordinate - CYC

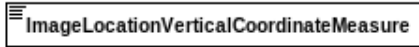

Field Reference: 9/CPF/CYC	Field ID: [09.361-F]
Content Type: Data	Condition: ?
XML Tag Name: ImageLocationVerticalCoordinateMeasure	Defined in: xsd/niem/biometrics/1.0/biometrics.xsd
Data Type: N	Special Characters: n/a
Minimum Length: 1	Maximum Length: 5
Minimum Occurrences: 0	Maximum Occurrences: 1
Value range: n/a	Regular Expression: n/a
Code table: n/a	
Base type: niem-xsd:integer	Namespace: http://niem.gov/niem/biometrics/1.0

Dependency table	
Type of dependency	Value
Mandatory on Value of other Field, optional otherwise.	[9/CPF/TOC]IN{"P","DP"}
Optional on Value of other Field, should not be set otherwise.	[9/CPF/TOC]="X"

XPath

```

/it1:PackageMinutiaeRecord
├─/biom:ExtendedFeatureSetMinutiae
│   └─/biom:MinutiaeFeatureCorrespondence
│       └─/biom:ImageLocationVerticalCoordinateMeasure
    
```

Summary

Y coordinate of feature/point (units of 10 micrometers).

Valid Examples

```
<biom:ImageLocationVerticalCoordinateMeasure>9880</biom:ImageLocationVerticalCoordinateMeasure>
```

10.238. Comment - COC

Field Reference: 9/CPF/COC
Content Type: Data
XML Tag Name: MinutiaeCommentText
Data Type: U
Minimum Length: 1
Minimum Occurrences: 0
Value range: *n/a*
Code table: *n/a*
Base type: nc:TextType

Field ID: [09.361-G]
Condition: Optional within a field
Defined in: xsd/niem/biometrics/1.0/biometrics.xsd
Special Characters: *n/a*
Maximum Length: 1000
Maximum Occurrences: 1
Regular Expression: *n/a*
Namespace: <http://niem.gov/niem/biometrics/1.0>

XPath

```
/itl:PackageMinutiaeRecord  
  ↳/biom:ExtendedFeatureSetMinutiae  
    ↳/biom:MinutiaeFeatureCorrespondence  
      ↳/biom:MinutiaeCommentText
```

Summary

Text comment or description related to the corresponding features and points.

10.239. EFS Examiner Comparison Determination - ECD

Field Reference: 9/ECD
Content Type: Set
XML Tag Name: MinutiaeExaminerComparisonDetermination
Data Type:
Minimum Length:
Minimum Occurrences: 0
Value range: *n/a*
Code table: *n/a*
Base type: biom:MinutiaeExaminerComparisonDeterminationType

Field ID: [09.362]
Condition: Dependent (see table)
Defined in: xsd/niem/biometrics/1.0/biometrics.xsd
Special Characters: *n/a*
Maximum Length:
Maximum Occurrences: *
Regular Expression: *n/a*

Namespace: <http://niem.gov/niem/biometrics/1.0>

Dependency table

Type of dependency	Value
Optional on Presence of other Field	9/ROI

XPath

```

/it1:PackageMinutiaeRecord
  ↳/biom:ExtendedFeatureSetMinutiae
    ↳/biom:MinutiaeExaminerComparisonDetermination
  
```

Summary

Examiner's determination based on analysis and comparison of two specified friction ridge images. If multiple examiners' determinations are represented, each is contained separately in a repeating subfield. Comparison determinations against multiple impressions in the same transaction are specified in a separate subfield with distinct IDC references.

10.240. IDC Reference - EDC

 IdentificationID

Field Reference: 9/ECD/EDC
Content Type: Data
XML Tag Name: IdentificationID
Data Type: N
Minimum Length: 1
Minimum Occurrences: 1
Value range: {0..99}
Code table: *n/a*
Base type: niem-xsd:string

Field ID: [09.362-A]
Condition: Mandatory within a field
Defined in: xsd/niem/niem-core/2.0/niem-core.xsd
Special Characters: *n/a*
Maximum Length: 2
Maximum Occurrences: 1
Regular Expression: *n/a*

Namespace: <http://niem.gov/niem/niem-core/2.0>

XPath

```

/itl:PackageMinutiaeRecord
  ↳/biom:ExtendedFeatureSetMinutiae
    ↳/biom:MinutiaeExaminerComparisonDetermination
      ↳/biom:ImageReferenceIdentification
        ↳/nc:IdentificationID
  
```

Summary

IDC for the target image for a given determination.

Valid Examples

```
<nc:IdentificationID>2</nc:IdentificationID>
```

10.241. Determination - EDE

Field Reference: 9/ECD/EDE

Content Type: Data

XML Tag Name: MinutiaeExaminerComparisonDeterminationResultCode

Data Type: AS

Minimum Length: 4

Minimum Occurrences: 1

Value range: *n/a*

Code table: see table [A.19](#)

Base type: biom:MinutiaeExaminerComparisonDeterminationResultCode

Field ID: [09.362-B]

Condition: Mandatory within a field

Defined in: xsd/niem/biometrics/1.0/biometrics.xsd

Special Characters: []

Maximum Length: 6

Maximum Occurrences: 1

Regular Expression: *n/a*

NameSpace: <http://niem.gov/niem/biometrics/1.0>

Exceptions

see Technical Notes below

XPath

```
/it1:PackageMinutiaeRecord
  ↙/biom:ExtendedFeatureSetMinutiae
    ↙/biom:MinutiaeExaminerComparisonDetermination
      ↙/biom:MinutiaeExaminerComparisonDeterminationResultCode
```

Summary

Comparison conclusion.

Technical Notes

The default value is "NONE".

Valid Examples

```
<biom:MinutiaeExaminerComparisonDeterminationResultCode>INC_I</biom:MinutiaeExaminerComparisonDeterminationResultCode>
```

10.242. Work in Progress - WIP

Field Reference: 9/ECD/WIP

Content Type: Data

XML Tag Name: MinutiaeExaminerProgressCode

Data Type: A

Minimum Length: 5

Minimum Occurrences: 1

Value range: {"PRELIMINARY", "FINAL"}

Code table: *n/a*

Base type: biom:MinutiaeExaminerProgressCodeType

Field ID: [09.362-C]

Condition: Mandatory within a field

Defined in: xsd/niem/biometrics/1.0/biometrics.xsd

Special Characters: *n/a*

Maximum Length: 11

Maximum Occurrences: 1

Regular Expression: *n/a*

Namespace: <http://niem.gov/niem/biometrics/1.0>

Exceptions

see Technical Notes below

XPath

```
/it1:PackageMinutiaeRecord
  ↳/biom:ExtendedFeatureSetMinutiae
    ↳/biom:MinutiaeExaminerComparisonDetermination
      ↳/biom:MinutiaeExaminerProgressCode
```

Summary

Status (preliminary or final).

Technical Notes

The default value is "PRELIMINARY".

Valid Examples

```
<biom:MinutiaeExaminerProgressCode>PRELIMINARY</biom:MinutiaeExaminerProgressCode>
```

10.243. Minutiae Examiner (XML)

Field Reference: 9/ECD/ELN_9/ECD/EFN
Content Type: Set_X
XML Tag Name: PersonName
Data Type:
Minimum Length:
Minimum Occurrences: 1
Value range: *n/a*
Code table: *n/a*
Base type: nc:PersonNameType

Field ID: [09.362-D_09.362-E]
Condition: Mandatory within a field
Defined in: xsd/niem/niem-core/2.0/niem-core.xsd
Special Characters: *n/a*
Maximum Length:
Maximum Occurrences: 1
Regular Expression: *n/a*
Namespace: <http://niem.gov/niem/niem-core/2.0>

XPath

```
/it1:PackageMinutiaeRecord  
  ↳/biom:ExtendedFeatureSetMinutiae  
    ↳/biom:MinutiaeExaminerComparisonDetermination  
      ↳/biom:MinutiaeExaminer  
        ↳/nc:PersonName
```

Summary

Minutiae examiner name.

Notes

Applies to 9.362-D and 9.362-E

10.244. Examiner Last Name - ELN

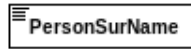

Field Reference: 9/ECD/ELN
Content Type: Data
XML Tag Name: PersonSurName
Data Type: U
Minimum Length: 1
Minimum Occurrences: 1
Value range: *n/a*
Code table: *n/a*
Base type: nc:PersonNameTextType

Field ID: [09.362-D]
Condition: Mandatory within a field
Defined in: xsd/niem/niem-core/2.0/niem-core.xsd
Special Characters: *n/a*
Maximum Length: 40
Maximum Occurrences: 1
Regular Expression: *n/a*

Namespace: <http://niem.gov/niem/niem-core/2.0>

XPath

```
/itl:PackageMinutiaeRecord  
  ↳/biom:ExtendedFeatureSetMinutiae  
    ↳/biom:MinutiaeExaminerComparisonDetermination  
      ↳/biom:MinutiaeExaminer  
        ↳/nc:PersonName  
          ↳/nc:PersonSurName
```

Summary

Surname of the fingerprint examiner.

Valid Examples

```
<nc:PersonSurName>Smith</nc:PersonSurName>
```

10.245. Examiner First Name - EFN

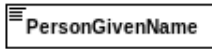

Field Reference: 9/ECD/EFN
Content Type: Data
XML Tag Name: PersonGivenName
Data Type: U
Minimum Length: 1
Minimum Occurrences: 1
Value range: *n/a*
Code table: *n/a*
Base type: nc:PersonNameTextType

Field ID: [09.362-E]
Condition: Mandatory within a field
Defined in: xsd/niem/niem-core/2.0/niem-core.xsd
Special Characters: *n/a*
Maximum Length: 40
Maximum Occurrences: 1
Regular Expression: *n/a*

Namespace: <http://niem.gov/niem/niem-core/2.0>

XPath

```
/itl:PackageMinutiaeRecord  
  ↳/biom:ExtendedFeatureSetMinutiae  
    ↳/biom:MinutiaeExaminerComparisonDetermination  
      ↳/biom:MinutiaeExaminer  
        ↳/nc:PersonName  
          ↳/nc:PersonGivenName
```

Summary

Given name (first name or first and middle names) of the fingerprint examiner.

Valid Examples

```
<nc:PersonGivenName>John</nc:PersonGivenName>
```

10.246. Examiner Affiliation - EAF

 OrganizationName

Field Reference: 9/ECD/EAF
Content Type: Data
XML Tag Name: OrganizationName
Data Type: U
Minimum Length: 1
Minimum Occurrences: 1
Value range: *n/a*
Code table: *n/a*
Base type: nc:TextType

Field ID: [09.362-F]
Condition: Mandatory within a field
Defined in: xsd/niem/niem-core/2.0/niem-core.xsd
Special Characters: *n/a*
Maximum Length: 99
Maximum Occurrences: 1
Regular Expression: *n/a*
Namespace: <http://niem.gov/niem/niem-core/2.0>

XPath

```
/itl:PackageMinutiaeRecord  
  ↳/biom:ExtendedFeatureSetMinutiae  
    ↳/biom:MinutiaeExaminerComparisonDetermination  
      ↳/biom:MinutiaeExaminerAffiliation  
        ↳/nc:OrganizationName
```

Summary

Employer or organizational affiliation of examiner.

Valid Examples

```
<nc:OrganizationName>FBI</nc:OrganizationName>
```

10.247. Date and Time (XML) - DTG

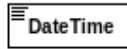

Field Reference: 9/ECD/DTG:X
Content Type: Data_X
XML Tag Name: DateTime
Data Type: ANS
Minimum Length: 20
Minimum Occurrences: 1
Value range: *n/a*
Code table: *n/a*
Base type: [niem-xsd:dateTime](#)

Field ID: [09.362-G:X]
Condition: Mandatory within a field
Defined in: [xsd/niem/niem-core/2.0/niem-core.xsd](#)
Special Characters: [-:]
Maximum Length: 20
Maximum Occurrences: 1
Regular Expression: \d{4}-\d{2}-\d{2}T\d{2}:\d{2}:\d{2}Z
Namespace: <http://niem.gov/niem/niem-core/2.0>

XPath

```

/itl:PackageMinutiaeRecord
├─/biom:ExtendedFeatureSetMinutiae
│   └─/biom:MinutiaeExaminerComparisonDetermination
│       └─/biom:MinutiaeExaminerComparisonDeterminationDateTime
│           └─/nc:DateTime

```

Summary

Date and time determination was made, in terms of Greenwich Mean Time units.

Valid Examples

```
<nc:DateTime>2007-01-01T00:00:01Z</nc:DateTime>
```

10.248. Comment - CZZ

Field Reference: 9/ECD/CZZ
Content Type: Data
XML Tag Name: MinutiaeCommentText
Data Type: U
Minimum Length: 1
Minimum Occurrences: 0
Value range: *n/a*
Code table: *n/a*
Base type: nc:TextType

Field ID: [09.362-H]
Condition: Optional within a field
Defined in: xsd/niem/biometrics/1.0/biometrics.xsd
Special Characters: *n/a*
Maximum Length: 200
Maximum Occurrences: 1
Regular Expression: *n/a*
Namespace: <http://niem.gov/niem/biometrics/1.0>

XPath

```
/itl:PackageMinutiaeRecord  
  ↳/biom:ExtendedFeatureSetMinutiae  
    ↳/biom:MinutiaeExaminerComparisonDetermination  
      ↳/biom:MinutiaeCommentText
```

Summary

Clarifying or qualifying information regarding comparison determination.

10.249. Complex Comparison Flag - CCF

Field Reference: 9/ECD/CCF

Content Type: Data

XML Tag Name: MinutiaeComparisonComplexityCode

Data Type: A

Minimum Length: 7

Minimum Occurrences: 0

Value range: {"COMPLEX"}

Code table: n/a

Base type: biom:MinutiaeAnalysisComplexityCodeType

Field ID: [09.362-I]

Condition: Optional within a field

Defined in: xsd/niem/biometrics/1.0/biometrics.xsd

Special Characters: n/a

Maximum Length: 7

Maximum Occurrences: 1

Regular Expression: n/a

Namespace: <http://niem.gov/niem/biometrics/1.0>

XPath

```
/it1:PackageMinutiaeRecord  
  ↳/biom:ExtendedFeatureSetMinutiae  
    ↳/biom:MinutiaeExaminerComparisonDetermination  
      ↳/biom:MinutiaeComparisonComplexityCode
```

Summary

Used only when examiner determines that the comparison was complex.

Valid Examples

```
<biom:MinutiaeComparisonComplexityCode>COMPLEX</biom:MinutiaeComparisonComplexityCode>
```

10.250. EFS Relative Rotation of Corresponding Print - RRC

Field Reference: 9/RRC	Field ID: [09.363]
Content Type: Set	Condition: Dependent (see table)
XML Tag Name: FrictionRidgeImageRelativeRotation	Defined in: xsd/niem/biometrics/1.0/biometrics.xsd
Data Type:	Special Characters: <i>n/a</i>
Minimum Length:	Maximum Length:
Minimum Occurrences: 0	Maximum Occurrences: *
Value range: <i>n/a</i>	Regular Expression: <i>n/a</i>
Code table: <i>n/a</i>	
Base type: biom:FrictionRidgeImageRelativeRotationType	Namespace: http://niem.gov/niem/biometrics/1.0

Dependency table

Type of dependency	Value
Optional on Presence of other Field	9/ROI

XPath

```

/it1:PackageMinutiaeRecord
  ↙/biom:ExtendedFeatureSetMinutiae
    ↙/biom:FrictionRidgeImageRelativeRotation
    
```

Summary

Relative overall rotation needed for two or more prints to be compared. The number of subfields is limited only by the number of Type-9 records in a transaction.

10.251. Rotation IDC Reference - RIR



Field Reference: 9/RRC/RIR
Content Type: Data
XML Tag Name: IdentificationID
Data Type: N
Minimum Length: 1
Minimum Occurrences: 1
Value range: {0..99}
Code table: *n/a*
Base type: niem-xsd:string

Field ID: [09.363-A]
Condition: Mandatory within a field
Defined in: xsd/niem/niem-core/2.0/niem-core.xsd
Special Characters: *n/a*
Maximum Length: 2
Maximum Occurrences: 1
Regular Expression: *n/a*

Namespace: <http://niem.gov/niem/niem-core/2.0>

XPath

```

/itl:PackageMinutiaeRecord
  ↳/biom:ExtendedFeatureSetMinutiae
    ↳/biom:FrictionRidgeImageRelativeRotation
      ↳/biom:ImageReferenceIdentification
        ↳/nc:IdentificationID
  
```

Summary

IDC for the Type-9 record associated with target image / Type-9 record for a given RRC.

Valid Examples

```
<nc:IdentificationID>2</nc:IdentificationID>
```

10.252. Relative Overall Rotation - ROR

Field Reference: 9/RRC/ROR

Content Type: Data

XML Tag Name: ImageRelativeOverallRotationValue

Data Type: NS

Minimum Length: 1

Minimum Occurrences: 1

Value range: {-179..180}

Code table: *n/a*

Base type: biom:RelativeRotationMeasureType

Field ID: [09.363-B]

Condition: Mandatory within a field

Defined in: xsd/niem/biometrics/1.0/biometrics.xsd

Special Characters: [-]

Maximum Length: 4

Maximum Occurrences: 1

Regular Expression: *n/a*

Namespace: <http://niem.gov/niem/biometrics/1.0>

XPath

```
/itl:PackageMinutiaeRecord
  ↳/biom:ExtendedFeatureSetMinutiae
    ↳/biom:FrictionRidgeImageRelativeRotation
      ↳/biom:ImageRelativeOverallRotationValue
```

Summary

Number of degrees the target image and/or features referenced by 9.363-A must be rotated to correspond with the designated Type-9 record. Positive numbers indicate degrees counterclockwise; negative numbers indicate degrees clockwise.

Valid Examples

```
<biom:ImageRelativeOverallRotationValue>101</biom:ImageRelativeOverallRotationValue>
```

10.253. EFS Skeletonized Image - SIM

Field Reference: 9/SIM	Field ID: [09.372]
Content Type: Data	Condition: Dependent (see table)
XML Tag Name: FrictionRidgeSkeletonizedImageBinaryObject	Defined in: xsd/niem/biometrics/1.0/biometrics.xsd
Data Type: Base64	Special Characters: <i>n/a</i>
Minimum Length: 8	Maximum Length: *
Minimum Occurrences: 0	Maximum Occurrences: 1
Value range: <i>n/a</i>	Regular Expression: <i>n/a</i>
Code table: <i>n/a</i>	
Base type: niem-xsd:base64Binary	Namespace: http://niem.gov/niem/biometrics/1.0

Dependency table

Type of dependency	Value
Optional on Presence of other Field	9/ROI

XPath

```
/it1:PackageMinutiaeRecord
  ↳/biom:ExtendedFeatureSetMinutiae
    ↳/biom:FrictionRidgeSkeletonizedImageBinaryObject
```

Summary

EFS skeletonized image (aka ridge tracing), which reduces the friction ridge impression to an image with thinned representations of each ridge.

Notes

The skeletonized image is stored as a 1-bit grayscale PNG compressed image, bit-packed 6 bits per character using Base-64 representation (See Annex A: Character encoding information). The entire PNG128 formatted image is included as a single data entry / information item. Interlacing, alpha transparency, and color palettes shall not be used. The skeletonized image's dimensions shall be identical width and height of the ROI (See Field 9.300). The resolution of the skeletonized image shall be the same as the original image, and shall be set in the PNG header. See section F.6.7 Ridge path: Skeletonized image and ridge path segments in ANSI/NIST for more information.

10.254. Minutiae Image Ridge Path Representation (XML) - RPS

Field Reference: 9/RPS:X1	Field ID: [09.373:X1]
Content Type: Set_X	Condition: Optional
XML Tag Name: MinutiaeImageRidgePathRepresentation	Defined in: xsd/niem/biometrics/1.0/biometrics.xsd
Data Type:	Special Characters: <i>n/a</i>
Minimum Length:	Maximum Length:
Minimum Occurrences: 0	Maximum Occurrences: 1
Value range: <i>n/a</i>	Regular Expression: <i>n/a</i>
Code table: <i>n/a</i>	
Base type: biom:MinutiaeImageRidgePathRepresentationType	Namespace: http://niem.gov/niem/biometrics/1.0

XPath

```
/it1:PackageMinutiaeRecord
  ↙/biom:ExtendedFeatureSetMinutiae
    ↙/biom:MinutiaeImageRidgePathRepresentation
```

Summary

Alternate representation of skeletonized image data contained in 9.372.

Notes

Each ridge path segment is saved as an open path (ordered set of vertices) and each skeletonized ridge segment is stored as a separate subfield. Each endpoint of a ridge segment is either shared by three ridge segments (at a bifurcation) or is unique to a single ridge segment (at a ridge ending). See section F.6.7 Ridge path: Skeletonized image and ridge path segments in ANSI/NIST for more information.

10.255. Minutiae Ridge Path Segment (XML) - RPS

Field Reference: 9/RPS:X2
Content Type: Set_X
XML Tag Name: MinutiaeRidgePathSegment
Data Type:
Minimum Length:
Minimum Occurrences: 1
Value range: *n/a*
Code table: *n/a*
Base type: biom:ImageSegmentPathType

Field ID: [09.373:X2]
Condition: Mandatory
Defined in: xsd/niem/biometrics/1.0/biometrics.xsd
Special Characters: *n/a*
Maximum Length:
Maximum Occurrences: *
Regular Expression: *n/a*
Namespace: <http://niem.gov/niem/biometrics/1.0>

XPath

```
/itl:PackageMinutiaeRecord  
  ↙/biom:ExtendedFeatureSetMinutiae  
    ↙/biom:MinutiaeImageRidgePathRepresentation  
      ↙/biom:MinutiaeRidgePathSegment
```

Summary

Alternate representation of skeletonized image data contained in 9.372.

10.256. Image Segment Vertex (XML) - RPS

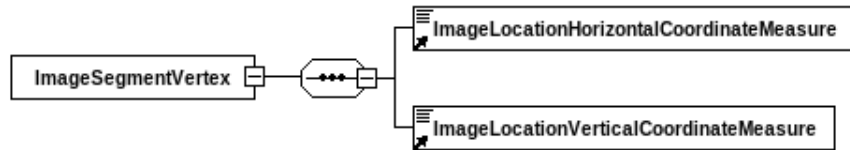

Field Reference: 9/RPS:X3
Content Type: Set_X
XML Tag Name: ImageSegmentVertex
Data Type:
Minimum Length:
Minimum Occurrences: 2
Value range: *n/a*
Code table: *n/a*
Base type: biom:ImageSegmentVertexType

Field ID: [09.373:X3]
Condition: Mandatory
Defined in: xsd/niem/biometrics/1.0/biometrics.xsd
Special Characters: *n/a*
Maximum Length:
Maximum Occurrences: 99
Regular Expression: *n/a*
Namespace: <http://niem.gov/niem/biometrics/1.0>

XPath

```

/itl:PackageMinutiaeRecord
├─ /biom:ExtendedFeatureSetMinutiae
│   └─ /biom:MinutiaeImageRidgePathRepresentation
│       └─ /biom:MinutiaeRidgePathSegment
│           └─ /biom:ImageSegmentVertex
    
```

Summary

Alternate representation of skeletonized image data contained in 9.372.

10.257. Image Location Horizontal Coordinate Measure (XML) - RPS

 ImageLocationHorizontalCoordinateMeasure
--

Field Reference: 9/RPS:X4

Content Type: Data_X

XML Tag Name: ImageLocationHorizontalCoordinateMeasure

Data Type: N

Minimum Length: 1

Minimum Occurrences: 1

Value range: {0..49999}

Code table: *n/a*

Base type: niem-xsd:integer

Field ID: [09.373:X4]

Condition: Mandatory

Defined in: xsd/niem/biometrics/1.0/biometrics.xsd

Special Characters: *n/a*

Maximum Length: 5

Maximum Occurrences: 1

Regular Expression: *n/a*

Namespace: <http://niem.gov/niem/biometrics/1.0>

XPath

```
/itl:PackageMinutiaeRecord
├─/biom:ExtendedFeatureSetMinutiae
│   └─/biom:MinutiaeImageRidgePathRepresentation
│       └─/biom:MinutiaeRidgePathSegment
│           └─/biom:ImageSegmentVertex
│               └─/biom:ImageLocationHorizontalCoordinateMeasure
```

Summary

Alternate representation of skeletonized image data contained in 9.372.

Valid Examples

<code><biom:ImageLocationHorizontalCoordinateMeasure>1530</biom:ImageLocationHorizontalCoordinateMeasure></code>
--

10.258. Image Location Vertical Coordinate Measure (XML) - RPS

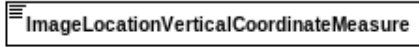

Field Reference: 9/RPS:X5	Field ID: [09.373:X5]
Content Type: Data_X	Condition: Mandatory
XML Tag Name: ImageLocationVerticalCoordinateMeasure	Defined in: xsd/niem/biometrics/1.0/biometrics.xsd
Data Type: N	Special Characters: <i>n/a</i>
Minimum Length: 1	Maximum Length: 5
Minimum Occurrences: 1	Maximum Occurrences: 1
Value range: {0..49999}	Regular Expression: <i>n/a</i>
Code table: <i>n/a</i>	
Base type: niem-xsd:integer	Namespace: http://niem.gov/niem/biometrics/1.0

XPath

```
/itl:PackageMinutiaeRecord
├─/biom:ExtendedFeatureSetMinutiae
│   └─/biom:MinutiaeImageRidgePathRepresentation
│       └─/biom:MinutiaeRidgePathSegment
│           └─/biom:ImageSegmentVertex
│               └─/biom:ImageLocationVerticalCoordinateMeasure
```

Summary

Alternate representation of skeletonized image data contained in 9.372.

Valid Examples

```
<biom:ImageLocationVerticalCoordinateMeasure>2510</biom:ImageLocationVerticalCoordinateMeasure>
```

10.259. Field Mandatoriness in Minutiae Data Record

The following table shows a summary of the fields and information items in each record type and its corresponding XML elements, and in particular the fields and items that are mandatory.

Table 10.1.: Field Summary for Type 9 Records

Field Id	Code	Field Name	Card.	Notes
9/XRCC:X	[09.001:X]	XML Record Category Code	M	
9/IDC	[09.002]	Information Designation Character	M	
9/IMP	[09.003]	Impression Type	M	
9/FMT:X	[09.004:X]	Minutia Format (XML)	M	
9/RMU:X	[09.013_09.225:X]	User-Defined Fields	O	
9/CBI_9/ADA	[09.126_09.141]	INCITS Minutiae (XML)	O	
9/CBI/CFO	[09.126-A]	CBEFF Format Owner	M [^]	This field is required (and not permitted otherwise) if 9/CEI is/are present.
9/CBI/CFT	[09.126-B]	CBEFF Format Type	M [^]	
9/CBI/CPI	[09.126-C]	CBEFF Product Identifier	M [^]	
9/CEI	[09.127]	M1 Capture Equipment ID	D	This field is required (and not permitted otherwise) if 9/CBI/CFO is/are present.
9/CEI/AFS	[09.127-A]	Appendix F Status	M [^]	
9/CEI/CID	[09.127-B]	Capture Equipment ID	M [^]	
9/HLL_9/FGP	[09.128_09.134]	Finger Impression Image (XML)	M	
9/HLL	[09.128]	M1 Horizontal Line Length	D	This field is required (and not permitted otherwise) if 9/CBI/CFO is/are present.
9/VLL	[09.129]	M1 Vertical Line Length	D	This field is required (and not permitted otherwise) if 9/CBI/CFO is/are present.
9/SLC	[09.130]	M1 Scale Units	D	This field is required (and not permitted otherwise) if 9/CBI/CFO is/are present.
9/THPS	[09.131]	M1 Transmitted Horizontal Pixel Scale	D	This field is required (and not permitted otherwise) if 9/CBI/CFO is/are present.
9/TVPS	[09.132]	M1 Transmitted Vertical Pixel Scale	D	This field is required (and not permitted otherwise) if 9/CBI/CFO is/are present.
9/FVW	[09.133]	M1 Finger View	D	This field is required (and not permitted otherwise) if 9/CBI/CFO is/are present.
9/FGP	[09.134]	M1 Friction Ridge Generalized Position	D	This field is required (and not permitted otherwise) if 9/CBI/CFO is/are present.
9/FQD	[09.135]	M1 Friction Ridge Quality Data	D	This field is required (and not permitted otherwise) if 9/CBI/CFO is/are present.
9/FQD/QVU	[09.135-A]	Quality Value	M [^]	
9/FQD/QAV	[09.135-B]	Algorithm Vendor Identification	O [^]	
9/FQD/QAP	[09.135-C]	Algorithm Product Identification	O [^]	
9/NOM	[09.136]	M1 Number of Minutiae	D	This field is required (and not permitted otherwise) if 9/CBI/CFO is/are present.
9/FMD:X	[09.137:X]	M1 Finger Minutiae Data (XML)	D	This field is required (and not permitted otherwise) if 9/CBI/CFO is/are present.
9/FMD/MAN	[09.137-A]	Minutia Index Number	M [^]	
9/FMD/MXC_9/FMD/MAV	[09.137-B_09.137-D]	INCITS Minutia Location (XML)	M	
9/FMD/MXC	[09.137-B]	X Coordinate	M [^]	

M=Mandatory, O=Optional, M[^]=Mandatory Info Item within a Field, O[^]=Optional Info Item within a Field, D=Dependent on other Fields/Info Items

10. Minutiae Data Record (aka Type 9)

Table 10.1.: Field Summary for Type 9 Records

Field Id	Code	Field Name	Card.	Notes
9/FMD/MYC	[09.137-C]	Y Coordinate	M [^]	
9/FMD/MAV	[09.137-D]	Minutia Angle	M [^]	
9/FMD/M1M	[09.137-E]	Minutia Type	M [^]	
9/FMD/QOM	[09.137-F]	Quality of Minutia	M [^]	
9/RCI	[09.138]	M1 Ridge Count Information	D	This field is optional (and should not be entered otherwise) if [9/CBI/CFT]IN514,515
9/RCI/REM	[09.138-A]	Ridge Count Extraction Method	M [^]	
9/RCI/CMI_9/RCI/NRC	[09.138-D_09.138-F]	Minutiae Ridge Count Item (XML)	M [^]	
9/RCI/CMI	[09.138-D]	Center Minutia Index Number	M [^]	
9/RCI/NMN	[09.138-E]	Neighboring Minutia Index Number	M [^]	
9/RCI/NRC	[09.138-F]	Number of Ridges Crossed	M [^]	
9/CIN	[09.139]	M1 Core Information	D	This field is optional (and should not be entered otherwise) if [9/CBI/CFT]IN514,515
9/CIN/XCC	[09.139-A]	X Coordinate	M [^]	
9/CIN/YCC	[09.139-B]	Y Coordinate	M [^]	
9/CIN/ANGC	[09.139-C]	Angle of the Core	M [^]	
9/DIN	[09.140]	M1 Delta Information	D	This field is optional (and should not be entered otherwise) if [9/CBI/CFT]IN514,515
9/DIN/XCD	[09.140-A]	X Coordinate	M [^]	
9/DIN/YCD	[09.140-B]	Y Coordinate	M [^]	
9/DIN/ANG1_9/ADA/ANG3	[09.140-C_09.141-B]	First, Second, and Third Angles of the Delta	M [^]	
9/ROI_9/RPS	[09.300_09.373]	Extended Feature Set Minutiae (XML)	O	
9/ROI	[09.300]	EFS Region of Interest	D	This field is required (and not permitted otherwise) if 9/FPP is/are present.
9/ROI/EWI	[09.300-A]	ROI Width	M [^]	
9/ROI/EHI	[09.300-B]	ROI Height	M [^]	
9/ROI/EHO	[09.300-C]	ROI Horizontal Offset	O [^]	If absent, defaults to zero.
9/ROI/EVO	[09.300-D]	ROI Vertical Offset	O [^]	If absent, defaults to zero.
9/ROI/ROP:X1	[09.300-E:X1]	ROI Polygon (XML)	O [^]	
9/ROI/ROP:X2	[09.300-E:X2]	Image Segment Vertex (XML)	M [^]	
9/ROI/ROP:X3	[09.300-E:X3]	Image Location Horizontal Coordinate Measure (XML)	M [^]	
9/ROI/ROP:X4	[09.300-E:X4]	Image Location Vertical Coordinate Measure (XML)	M [^]	
9/ORT	[09.301]	EFS Orientation	D	This field is optional but is only permitted if 9/ROI is/are present.
9/ORT/EOD	[09.301-A]	Direction	M [^]	If field is omitted, the direction shall default to 0 (upright).
9/ORT/EUC	[09.301-B]	Uncertainty	O [^]	If field is omitted, the direction shall default to 0 (upright).
9/FPP	[09.302]	EFS Finger, Palm, Plantar Position	D	This field is required (and not permitted otherwise) if 9/ROI is/are present.
9/FPP/FGP	[09.302-A]	Friction Ridge Generalized Position	M [^]	
9/FPP/SGP:X1	[09.302-D:X1]	Segment Polygon (XML)	O [^]	
9/FPP/SGP:X2	[09.302-D:X2]	Image Segment Vertex (XML)	M [^]	
9/FPP/SGP:X3	[09.302-D:X3]	Image Location Horizontal Coordinate Measure (XML)	M [^]	
9/FPP/SGP:X4	[09.302-D:X4]	Image Location Vertical Coordinate Measure (XML)	M [^]	

M=Mandatory, O=Optional, M[^]=Mandatory Info Item within a Field, O[^]=Optional Info Item within a Field, D=Dependent on other Fields/Info Items

10. Minutiae Data Record (aka Type 9)

Table 10.1.: Field Summary for Type 9 Records

Field Id	Code	Field Name	Card.	Notes
9/FSP	[09.303]	EFS Feature Set Profile	D	<ul style="list-style-type: none"> This field is optional but is only permitted if 9/ROI is/are present. Note this can have multiple occurrences, so the requirements apply if ANY of the 9/FSP occurrences is defined. If 9/FSP=1, then (either 9/COR or 9/NCOR is required) and (either 9/DEL or 9/NDEL is required). 9/FSP=2 has requirements of 9/FSP=1 as well as (either 9/MIN or 9/NMIN is required). 9/FSP=3 has the requirements of 9/FSP=1 and 2 as well as required 9/RQM, 9/RFM, and (either 9/DOT or 9/NDOT) and (either 9/INR or 9/NINR).
9/PAT	[09.307]	EFS Pattern Classification	D	This field is optional but is only permitted if 9/ROI is/are present.
9/PAT/GCF	[09.307-A]	General Class	M [^]	
9/PAT/SUB	[09.307-B]	Subclass	D [^]	This field is optional (and should not be entered otherwise) if [9/PAT/GCF]IN"AU","WU"
9/PAT/WDR	[09.307-C]	Whorl-Delta Relationship	D [^]	This field is optional (and should not be entered otherwise) if [9/PAT/SUB]IN"PW","CP","DL","AW"
9/RQM:X	[09.308:X]	EFS Ridge Quality Map (XML)	D	<ul style="list-style-type: none"> This field is optional but is only permitted if 9/ROI is/are present. This field is required (and optional otherwise) if [9/FSP]=3 If 9/RQF/RDF="UNC", permissible characters are [0..5]; otherwise permissible characters are [0..9][A..F], coincidentally the same as hexadecimal.
9/RQF:X	[09.309:X]	Ridge Quality Map Format (XML)	D	This field is required (and not permitted otherwise) if 9/RQM:X is/are present.
9/RQF/GSZ	[09.309-A]	Grid Size	M [^]	
9/RQF/RDF	[09.309-B]	Ridge Quality Data Format	M [^]	
9/RFM:X	[09.310:X]	EFS Ridge Flow Map (XML)	M	<ul style="list-style-type: none"> This field is required (and optional otherwise) if [9/FSP]=3 If 9/RFM/RDF="UNC", the DataType is H (hexadecimal), otherwise Base64.
9/RFM:X	[09.311:X]	EFS Ridge Flow Map Format (XML)	D	This field is optional but is only permitted if 9/RFM:X is/are present.

M=Mandatory, O=Optional, M[^]=Mandatory Info Item within a Field, O[^]=Optional Info Item within a Field, D=Dependent on other Fields/Info Items

10. Minutiae Data Record (aka Type 9)

Table 10.1.: Field Summary for Type 9 Records

Field Id	Code	Field Name	Card.	Notes
9/RFF/SFQ	[09.311-A]	Sampling Frequency	M [^]	Default value is "41".
9/RFF/RDF	[09.311-B]	Ridge Flow Data Format	M [^]	Default value is "UNC".
9/RWM:X	[09.312:X]	EFS Ridge Wavelength Map (XML)	D	<ul style="list-style-type: none"> This field is optional but is only permitted if 9/RWF:X is/are present. The number of occurrences must either be 0 or (9/EHI divided by 9/RWF/FWS). The length of each value must be (2 * 9/EWI divided by 9/RWF/FWS). Valid characters are [0..9][*X*].
9/RWF:X	[09.313:X]	EFS Ridge Wavelength Map Format (XML)	D	This field is optional but is only permitted if 9/RWM:X is/are present.
9/RWF/FWS	[09.313-A]	Sampling Frequency	M [^]	Default value is "41".
9/RWF/FDF	[09.313-B]	Data Format	M [^]	Default value is "UNC".
9/TRV	[09.314]	EFS Tonal Reversal	D	This field is optional but is only permitted if 9/ROI is/are present.
9/PLR	[09.315]	EFS Possible Lateral Reversal	D	This field is optional but is only permitted if 9/ROI is/are present.
9/FQM	[09.316]	EFS Friction Ridge Quality Metric	D	This field is optional but is only permitted if 9/ROI is/are present.
9/FQM/QVU	[09.316-A]	Quality Value	M [^]	
9/FQM/QAV	[09.316-B]	Algorithm Vendor Identification	M [^]	
9/FQM/QAP	[09.316-C]	Algorithm Product Identification	M [^]	
9/PGS	[09.317]	EFS Possible Growth or Shrinkage	D	This field is optional but is only permitted if 9/ROI is/are present.
9/PGS/TGS	[09.317-A]	Growth or Shrinkage Type	M [^]	
9/PGS/CGS:X	[09.317-B:X]	Growth or Shrinkage Comment (XML)	O [^]	
9/COR:X	[09.320:X]	EFS Cores (XML)	D	<ul style="list-style-type: none"> This field is only permitted if 9/NCOR:X is/are absent. If palm/plantar 9/FPP/FGP >= 18, MaxOccur=*; if 9/PAT/SUB="AW", MaxOccur=*; if 9/PAT/SUB="PA", MaxOccur=0; if 9/PAT/SUB="TA", MaxOccur=1; if 9/PAT/GCF="LS" or "RS", MaxOccur=1; if 9/PAT/GCF="WU", MaxOccur=2.
9/COR/CXC	[09.320-A]	X Coordinate	M [^]	
9/COR/CYC	[09.320-B]	Y Coordinate	M [^]	
9/COR/CDI	[09.320-C]	Direction	O [^]	
9/COR/RPU	[09.320-D]	Radius of Position Uncertainty	O [^]	
9/COR/DUY	[09.320-E]	Direction Uncertainty	O [^]	

M=Mandatory, O=Optional, M[^]=Mandatory Info Item within a Field, O[^]=Optional Info Item within a Field, D=Dependent on other Fields/Info Items

10. Minutiae Data Record (aka Type 9)

Table 10.1.: Field Summary for Type 9 Records

Field Id	Code	Field Name	Card.	Notes
9/DEL:X	[09.321:X]	EFS Deltas (XML)	D	<ul style="list-style-type: none"> This field is only permitted if 9/NDEL:X is/are absent. If palm/plantar 9/FPP/FGP\geq18, MaxOccur=*. Otherwise, if 9/PAT/SUB="AW", MaxOccur=*; if 9/PAT/SUB="PA", MaxOccur=0; if 9/PAT/SUB="TA", MaxOccur=1; if 9/PAT/GCF="LS" or "RS", MaxOccur=1; if 9/PAT/GCF="WU", MaxOccur=2.
9/DEL/DXC	[09.321-A]	X Coordinate	M [^]	
9/DEL/DYC	[09.321-B]	Y Coordinate	M [^]	
9/DEL/DUP	[09.321-C]	Direction Up	O [^]	
9/DEL/DLF	[09.321-D]	Direction Left	O [^]	
9/DEL/DRT	[09.321-E]	Direction Right	O [^]	
9/DEL/DTP	[09.321-F]	Type	O [^]	
9/DEL/RPU	[09.321-G]	Radius of Position Uncertainty	O [^]	
9/DEL/DUU	[09.321-H]	Direction Uncertainty Up	O [^]	
9/DEL/DUL	[09.321-I]	Direction Uncertainty Left	O [^]	
9/DEL/DUR	[09.321-J]	Direction Uncertainty Right	O [^]	
9/CDR	[09.322]	EFS Core-Delta Ridge Counts	D	This field is optional but is only permitted if 9/ROI is/are present.
9/CDR/CIX	[09.322-A]	Core Index	M [^]	
9/CDR/DIX	[09.322-B]	Delta index	M [^]	
9/CDR/MNRC	[09.322-C]	Min Ridge Count	M [^]	
9/CDR/MXRC	[09.322-D]	Max Ridge Count	O [^]	
9/CPR	[09.323]	EFS Center Point of Reference	D	This field is optional but is only permitted if 9/ROI is/are present.
9/CPR/CPM	[09.323-A]	Method	M [^]	
9/CPR/PXC	[09.323-B]	X Coordinate	M [^]	
9/CPR/PYC	[09.323-C]	Y Coordinate	M [^]	
9/CPR/CRU	[09.323-D]	Radius of Position Uncertainty	O [^]	
9/DIS:X	[09.324:X]	EFS Distinctive Features (XML)	D	This field is only permitted if 9/NDIS:X is/are absent.
9/DIS/DIT	[09.324-A]	Distinctive Feature Type	M [^]	
9/DIS/DFP:X1	[09.324-B:X1]	Distinctive Features Polygon (XML)	O [^]	
9/DIS/DFP:X2	[09.324-B:X2]	Image Segment Vertex (XML)	M [^]	
9/DIS/DFP:X3	[09.324-B:X3]	Image Location Horizontal Coordinate Measure (XML)	M [^]	
9/DIS/DFP:X4	[09.324-B:X4]	Image Location Vertical Coordinate Measure (XML)	M [^]	
9/DIS/DFC	[09.324-C]	Distinctive Features Comment	O [^]	
9/NCOR:X	[09.325:X]	EFS No Cores Present (XML)	D	This field is only permitted if 9/COR:X is/are absent.
9/NDEL:X	[09.326:X]	EFS No Deltas Present (XML)	D	This field is only permitted if 9/DEL:X is/are absent.
9/NDIS:X	[09.327:X]	EFS No Distinctive Features Present (XML)	D	This field is only permitted if 9/DIS:X is/are absent.
9/MIN:X	[09.331:X]	EFS Minutiae (XML)	D	This field is only permitted if 9/NMIN:X is/are absent.
9/MIN/MXC	[09.331-A]	X Coordinate	M [^]	
9/MIN/MYC	[09.331-B]	Y Coordinate	M [^]	
9/MIN/MTD	[09.331-C]	Theta Degrees	M [^]	

M=Mandatory, O=Optional, M[^]=Mandatory Info Item within a Field, O[^]=Optional Info Item within a Field, D=Dependent on other Fields/Info Items

10. Minutiae Data Record (aka Type 9)

Table 10.1.: Field Summary for Type 9 Records

Field Id	Code	Field Name	Card.	Notes
9/MIN/MTY	[09.331-D]	Minutia Type	M [^]	
9/MIN/MRU	[09.331-E]	Radius of Position Uncertainty	O [^]	This field is required (and optional otherwise) if [9/MIN/MTY]="X"
9/MIN/MDU	[09.331-F]	Minutiae Direction of Uncertainty	O [^]	
9/MRA	[09.332]	EFS Minutiae Ridge Count Algorithm	D	<ul style="list-style-type: none"> This field is optional but is only permitted if 9/MRC is/are present. This field is required (and optional otherwise) if [9/FSP]=11
9/MRC	[09.333]	EFS Minutiae Ridge Counts	D	<ul style="list-style-type: none"> This field is optional but is only permitted if 9/ROI is/are present. This field is required (and optional otherwise) if [9/FSP]=11
9/MRC/MIA	[09.333-A]	Minutia Index A	M [^]	
9/MRC/MIB	[09.333-B]	Minutia Index B	M [^]	
9/MRC/MIR	[09.333-C]	Ridge Count	M [^]	
9/MRC/MRN	[09.333-D]	Reference Number	O [^]	
9/MRC/MRS	[09.333-E]	Residual	O [^]	
9/NMIN:X	[09.334:X]	EFS No Minutia Present (XML)	D	This field is only permitted if 9/MIN:X is/are absent.
9/RCC	[09.335]	EFS Ridge Count Confidence	D	This field is optional but is only permitted if 9/ROI is/are present.
9/RCC/ACX_9/RCC/ACY	[09.335-A_09.335-B]	Minutia Location Point (XML)	M [^]	
9/RCC/ACX	[09.335-A]	X Coordinate Point A	M [^]	
9/RCC/ACY	[09.335-B]	Y Coordinate Point A	M [^]	
9/RCC/BCX_9/RCC/BCY	[09.335-C_09.335-D]	Minutia Location Reference Point (XML)	M [^]	
9/RCC/BCX	[09.335-C]	X Coordinate Point B	M [^]	
9/RCC/BCY	[09.335-D]	Y Coordinate Point B	M [^]	
9/RCC/MORC	[09.335-E]	Method of Ridge Counting	M [^]	
9/RCC/MCV	[09.335-F]	Confidence Value	M [^]	
9/DOT:X	[09.340:X]	EFS Dots (XML)	D	This field is only permitted if 9/NDOT:X is/are absent.
9/DOT/DOX	[09.340-A]	Dot X Coordinate	M [^]	
9/DOT/DOY	[09.340-B]	Dot Y Coordinate	M [^]	
9/DOT/DOL	[09.340-C]	Dot Length	O [^]	
9/INR:X	[09.341:X]	EFS Incipient Ridges (XML)	D	This field is only permitted if 9/NINR:X is/are absent.
9/INR/X1C_9/INR/Y1C	[09.341-A_09.341-B]	Minutia Location Point (XML)	M [^]	
9/INR/X1C	[09.341-A]	X Coordinate Point 1	M [^]	
9/INR/Y1C	[09.341-B]	Y Coordinate Point 1	M [^]	
9/INR/X2C_9/INR/Y2C	[09.341-C_09.341-D]	Minutia Location Reference Point (XML)	M [^]	
9/INR/X2C	[09.341-C]	X Coordinate Point 2	M [^]	
9/INR/Y2C	[09.341-D]	Y Coordinate Point 2	M [^]	
9/CLD:X	[09.342:X]	EFS Creases and Linear Discontinuities (XML)	D	This field is only permitted if 9/NCLD:X is/are absent.
9/CLD/X1D_9/CLD/Y1D	[09.342-A_09.342-B]	Minutia Location Point (XML)	M [^]	
9/CLD/X1D	[09.342-A]	X Coordinate Point 1	M [^]	
9/CLD/Y1D	[09.342-B]	Y Coordinate Point 1	M [^]	

M=Mandatory, O=Optional, M[^]=Mandatory Info Item within a Field, O[^]=Optional Info Item within a Field, D=Dependent on other Fields/Info Items

10. Minutiae Data Record (aka Type 9)

Table 10.1.: Field Summary for Type 9 Records

Field Id	Code	Field Name	Card.	Notes
9/CLD/X2D_9/CLD/Y2D	[09.342-C_09.342-D]	Minutia Location Reference Point (XML)	M [^]	
9/CLD/X2D	[09.342-C]	X Coordinate Point 2	M [^]	
9/CLD/Y2D	[09.342-D]	Y Coordinate Point 2	M [^]	
9/CLD/TPD	[09.342-E]	Type	M [^]	
9/REF:X	[09.343:X]	EFS Ridge Edge Features (XML)	D	This field is only permitted if 9/NREF:X is/are absent.
9/REF/CLX	[09.343-A]	X Coordinate	M [^]	
9/REF/CLY	[09.343-B]	Y Coordinate	M [^]	
9/REF/CLT	[09.343-C]	Type	M [^]	
9/NPOR:X	[09.344:X]	EFS No Pores Present (XML)	D	This field is only permitted if 9/POR:X is/are absent.
9/POR:X	[09.345:X]	EFS Pores (XML)	D	This field is only permitted if 9/NPOR:X is/are absent.
9/POR/POX	[09.345-A]	X Coordinate	M [^]	
9/POR/POY	[09.345-B]	Y Coordinate	M [^]	
9/NDOT:X	[09.346:X]	EFS No Dots Present (XML)	D	This field is only permitted if 9/DOT:X is/are absent.
9/NINR:X	[09.347:X]	EFS No Incipient Ridges Present (XML)	D	This field is only permitted if 9/INR:X is/are absent.
9/NCLD:X	[09.348:X]	EFS No Creases Present (XML)	D	This field is only permitted if 9/CLD:X is/are absent.
9/NREF:X	[09.349:X]	EFS No Ridge Edge Features Present (XML)	D	This field is only permitted if 9/REF:X is/are absent.
9/MFD	[09.350]	EFS Method of Feature Detection	D	This field is optional but is only permitted if 9/ROI is/are present.
9/MFD/FIE	[09.350-A]	Field	M [^]	
9/MFD/FME	[09.350-B]	Method	M [^]	
9/MFD/FAV	[09.350-C]	Algorithm Vendor	D [^]	This field is optional (and should not be entered otherwise) if [9/MFD/FME]IN"AUTO","REV","EDIT"
9/MFD/FAL	[09.350-D]	Algorithm	D [^]	This field is optional (and should not be entered otherwise) if [9/MFD/FME]IN"AUTO","REV","EDIT"
9/MFD/ESN_9/MFD/EGN	[09.350-E_09.350-F]	Minutiae Examiner (XML)	O [^]	
9/MFD/ESN	[09.350-E]	Examiner Surname	D [^]	This field is optional (and should not be entered otherwise) if [9/MFD/FME]IN"MAN","REV","EDIT"
9/MFD/EGN	[09.350-F]	Examiner Given Name	D [^]	This field is optional (and should not be entered otherwise) if [9/MFD/FME]IN"MAN","REV","EDIT"
9/MFD/EAF	[09.350-G]	Examiner Affiliation	D [^]	This field is optional (and should not be entered otherwise) if [9/MFD/FME]IN"MAN","REV","EDIT"
9/MFD/EMT:X	[09.350-H:X]	Date and Time (XML)	O [^]	
9/MFD/NTS	[09.350-I]	Notes	O [^]	
9/COM	[09.351]	EFS Comment	D	This field is optional but is only permitted if 9/ROI is/are present.
9/LPM	[09.352]	EFS Latent Processing Method	D	This field is optional but is only permitted if 9/ROI is/are present.
9/EAA	[09.353]	EFS Examiner Analysis Assessment	D	This field is optional but is only permitted if 9/ROI is/are present.
9/EAA/AAV	[09.353-A]	Value Assessment Code	M [^]	
9/EAA/ALN_9/EAA/AFN	[09.353-B_09.353-C]	Minutiae Examiner (XML)	M [^]	
9/EAA/ALN	[09.353-B]	Examiner Last Name	M [^]	
9/EAA/AFN	[09.353-C]	Examiner First Name	M [^]	
9/EAA/AAF	[09.353-D]	Examiner Affiliation	M [^]	
9/EAA/AMT:X	[09.353-E:X]	Date and Time (XML)	M [^]	
9/EAA/ACM	[09.353-F]	Comment	O [^]	

M=Mandatory, O=Optional, M[^]=Mandatory Info Item within a Field, O[^]=Optional Info Item within a Field, D=Dependent on other Fields/Info Items

10. Minutiae Data Record (aka Type 9)

Table 10.1.: Field Summary for Type 9 Records

Field Id	Code	Field Name	Card.	Notes
9/EAA/CXF	[09.353-G]	Analysis Complexity Flag	O [^]	
9/EOF	[09.354]	EFS Evidence of Fraud	D	This field is optional but is only permitted if 9/ROI is/are present.
9/EOF/FRA	[09.354-A]	Fraud Type	M [^]	
9/EOF/CFD	[09.354-B]	Comment	O [^]	
9/LSB	[09.355]	EFS Latent Substrate	D	This field is optional but is only permitted if 9/ROI is/are present.
9/LSB/CLS	[09.355-A]	Code	M [^]	
9/LSB/OSD	[09.355-B]	Object/Substrate Description	O [^]	
9/LMT	[09.356]	EFS Latent Matrix	D	This field is optional but is only permitted if 9/ROI is/are present.
9/LMT/TOM	[09.356-A]	Code	M [^]	
9/LMT/CLA	[09.356-B]	Comment	O [^]	
9/LQI	[09.357]	EFS Local Quality Issues	D	This field is optional but is only permitted if 9/ROI is/are present.
9/LQI/LQT	[09.357-A]	Type	M [^]	
9/LQI/LQP:X1	[09.357-B:X1]	Image Segment Polygon (XML)	M [^]	
9/LQI/LQP:X2	[09.357-B:X2]	Image Segment Vertex (XML)	M [^]	
9/LQI/LQP:X3	[09.357-B:X3]	Image Location Horizontal Coordinate Measure (XML)	M [^]	
9/LQI/LQP:X4	[09.357-B:X4]	Image Location Vertical Coordinate Measure (XML)	M [^]	
9/LQI/LQC	[09.357-C]	Comment	O [^]	
9/AOC	[09.360]	EFS Area of Correspondence	D	This field is optional but is only permitted if 9/ROI is/are present.
9/AOC/CIR	[09.360-A]	IDC Reference	M [^]	
9/AOC/AOP:X1	[09.360-B:X1]	Image Segment Polygon (XML)	M [^]	
9/AOC/AOP:X2	[09.360-B:X2]	Image Segment Vertex (XML)	M [^]	
9/AOC/AOP:X3	[09.360-B:X3]	Image Location Horizontal Coordinate Measure (XML)	M [^]	
9/AOC/AOP:X4	[09.360-B:X4]	Image Location Vertical Coordinate Measure (XML)	M [^]	
9/AOC/CAC	[09.360-C]	Comment	O [^]	
9/CPF	[09.361]	EFS Corresponding Points or Features	D	This field is optional but is only permitted if 9/ROI is/are present.
9/CPF/COL	[09.361-A]	Label	M [^]	
9/CPF/TOC	[09.361-B]	Type of Correspondence	M [^]	
9/CPF/CFN	[09.361-C]	Corresponding Field Number	D [^]	This field is required (and not permitted otherwise) if [9/CPF/TOC]IN"F","DF"
9/CPF/FOC	[09.361-D]	Corresponding Field Occurrence	D [^]	This field is required (and not permitted otherwise) if [9/CPF/TOC]IN"F","DF"
9/CPF/CXC	[09.361-E]	Corresponding X Coordinate	D [^]	<ul style="list-style-type: none"> • This field is required (and optional otherwise) if [9/CPF/-TOC]IN{"P","DP"} • This field is optional (and should not be entered otherwise) if [9/CPF/TOC]="X"

M=Mandatory, O=Optional, M[^]=Mandatory Info Item within a Field, O[^]=Optional Info Item within a Field, D=Dependent on other Fields/Info Items

10. Minutiae Data Record (aka Type 9)

Table 10.1.: Field Summary for Type 9 Records

Field Id	Code	Field Name	Card.	Notes
9/CPF/CYC	[09.361-F]	Corresponding Y Coordinate	D [^]	<ul style="list-style-type: none"> This field is required (and optional otherwise) if [9/CPF/-TOC]IN{"P","DP"} This field is optional (and should not be entered otherwise) if [9/CPF/TOC]="X"
9/CPF/COC	[09.361-G]	Comment	O [^]	
9/ECD	[09.362]	EFS Examiner Comparison Determination	D	This field is optional but is only permitted if 9/ROI is/are present.
9/ECD/EDC	[09.362-A]	IDC Reference	M [^]	
9/ECD/EDE	[09.362-B]	Determination	M [^]	The default value is "NONE".
9/ECD/WIP	[09.362-C]	Work in Progress	M [^]	The default value is "PRELIMINARY".
9/ECD/ELN_9/ECD/EFN	[09.362-D_09.362-E]	Minutiae Examiner (XML)	M [^]	
9/ECD/ELN	[09.362-D]	Examiner Last Name	M [^]	
9/ECD/EFN	[09.362-E]	Examiner First Name	M [^]	
9/ECD/EAF	[09.362-F]	Examiner Affiliation	M [^]	
9/ECD/DTG:X	[09.362-G:X]	Date and Time (XML)	M [^]	
9/ECD/CZZ	[09.362-H]	Comment	O [^]	
9/ECD/CCF	[09.362-I]	Complex Comparison Flag	O [^]	
9/RRC	[09.363]	EFS Relative Rotation of Corresponding Print	D	This field is optional but is only permitted if 9/ROI is/are present.
9/RRC/RIR	[09.363-A]	Rotation IDC Reference	M [^]	
9/RRC/ROR	[09.363-B]	Relative Overall Rotation	M [^]	
9/SIM	[09.372]	EFS Skeletonized Image	D	This field is optional but is only permitted if 9/ROI is/are present.
9/RPS:X1	[09.373:X1]	Minutiae Image Ridge Path Representation (XML)	O	
9/RPS:X2	[09.373:X2]	Minutiae Ridge Path Segment (XML)	M	
9/RPS:X3	[09.373:X3]	Image Segment Vertex (XML)	M	
9/RPS:X4	[09.373:X4]	Image Location Horizontal Coordinate Measure (XML)	M	
9/RPS:X5	[09.373:X5]	Image Location Vertical Coordinate Measure (XML)	M	

M=Mandatory, O=Optional, M[^]=Mandatory Info Item within a Field, O[^]=Optional Info Item within a Field, D=Dependent on other Fields/Info Items

11. Photographic Body Part Imagery Record (aka Type 10)

This chapter describes all the fields that are used in the Photographic Body Part Imagery Record.

11.1. Package Facial And SMT Image Record (XML)

Field Reference: 10	Field ID: [10]
Content Type: Set_X	Condition: Optional
XML Tag Name: PackageFacialAndSMTImageRecord	Defined in: xsd/itl/2011/ITL-2007f-Package.xsd
Data Type:	Special Characters: n/a
Minimum Length:	Maximum Length:
Minimum Occurrences: 0	Maximum Occurrences: *
Value range: n/a	Regular Expression: n/a
Code table: n/a	
Base type: itl:PackageFacialAndSMTImageRecordType	Namespace: http://biometrics.nist.gov/standard/2011

XPath

/itl:PackageFacialAndSMTImageRecord

Summary

Face, SMT, and/or other body part image data and related information pertaining to the specific image contained in this record.

11.2. XML Record Category Code - XRCC

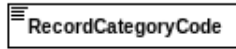

Field Reference: 10/XRCC:X
Content Type: Data_X
XML Tag Name: RecordCategoryCode
Data Type: N
Minimum Length: 1
Minimum Occurrences: 1
Value range: {10}
Code table: *n/a*
Base type: biom:RecordCategoryCodeType

Field ID: [10.001:X]
Condition: Mandatory
Defined in: xsd/niem/biometrics/1.0/biometrics.xsd
Special Characters: *n/a*
Maximum Length: 2
Maximum Occurrences: 1
Regular Expression: *n/a*
Namespace: <http://niem.gov/niem/biometrics/1.0>

XPath

```
/it1:PackageFacialAndSMTImageRecord  
  ↘/biom:RecordCategoryCode
```

Summary

Numeric representation of Record Type.

Valid Examples

```
<biom:RecordCategoryCode>10</biom:RecordCategoryCode>
```

11.3. Information Designation Character - IDC

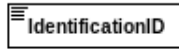

Field Reference: 10/IDC

Content Type: Data

XML Tag Name: IdentificationID

Data Type: N

Minimum Length: 1

Minimum Occurrences: 1

Value range: {0..99}

Code table: *n/a*

Base type: niem-xsd:string

Field ID: [10.002]

Condition: Mandatory

Defined in: xsd/niem/niem-core/2.0/niem-core.xsd

Special Characters: *n/a*

Maximum Length: 2

Maximum Occurrences: 1

Regular Expression: *n/a*

Namespace: <http://niem.gov/niem/niem-core/2.0>

XPath

```
/it1:PackageFacialAndSMTImageRecord  
  ↙/biom:ImageReferenceIdentification  
    ↙/nc:IdentificationID
```

Summary

IDC assigned to this Type-10 record as listed in field 1.003.

Valid Examples

```
<nc:IdentificationID>4</nc:IdentificationID>
```

11.4. Face or Physical Feature Indication (XML)

Field Reference: 10/IMT_10/DATA	Field ID: [10.003_10.999]
Content Type: Set_X	Condition: Mandatory
XML Tag Name: FaceImage or PhysicalFeatureImage	Defined in: xsd/niem/biometrics/1.0/biometrics.xsd
Data Type:	Special Characters: <i>n/a</i>
Minimum Length:	Maximum Length:
Minimum Occurrences: 1	Maximum Occurrences: 1
Value range: <i>n/a</i>	Regular Expression: <i>n/a</i>
Code table: <i>n/a</i>	
Base type: biom:FaceImageType or biom:PhysicalFeatureImageType	Namespace: http://niem.gov/niem/biometrics/1.0

XPath

```
if [10/IMT] IN "FACE" then
/itl:PackageFacialAndSMTImageRecord
  ↪/biom:FaceImage
else
/itl:PackageFacialAndSMTImageRecord
  ↪/biom:PhysicalFeatureImage
endif
```

Summary

Image and associated information.

Notes

Applies to 10.003, 10.004, 10.005, 10.006, 10.007, 10.008, 10.009, 10.010, 10.011, 10.012, 10.016, 10.017, 10.018, 10.024, 10.030, 10.038, 10.044, 10.903, 10.904, 10.993, 10.998, and 10.999.

11. Photographic Body Part Imagery Record (aka Type 10)

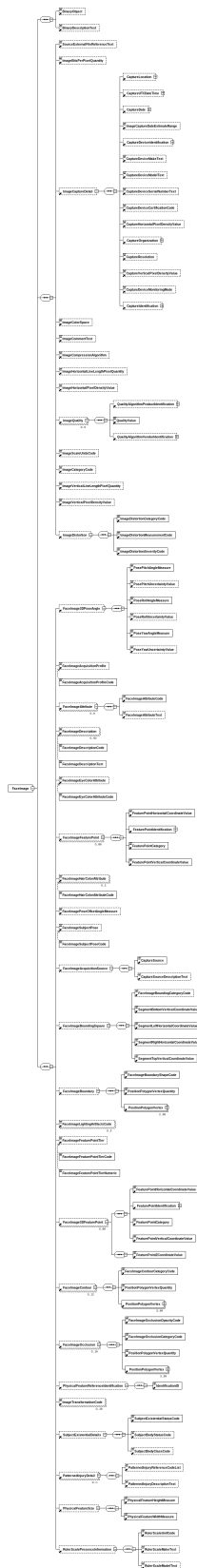

11.5. Image Type - IMT

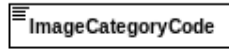

Field Reference: 10/IMT	Field ID: [10.003]
Content Type: Data	Condition: Mandatory
XML Tag Name: ImageCategoryCode	Defined in: xsd/niem/biometrics/1.0/biometrics.xsd
Data Type: AS	Special Characters: [-]
Minimum Length: 4	Maximum Length: 11
Minimum Occurrences: 1	Maximum Occurrences: 1
Value range: {"FACE"}	Regular Expression: <i>n/a</i>
Code table: <i>n/a</i>	
Base type: biom:PersonImageCategoryCodeType	Namespace: http://niem.gov/niem/biometrics/1.0

XPath

```

if [10/IMT] IN "FACE" then
/it1:PackageFacialAndSMTImageRecord
  ↙/biom:FaceImage
    ↙/biom:ImageCategoryCode
else
/it1:PackageFacialAndSMTImageRecord
  ↙/biom:PhysicalFeatureImage
    ↙/biom:ImageCategoryCode
endif
    
```

Summary

Type of image contained in the record.

Notes

Even though the ANSI-NIST standard allows a large number of types, only the "FACE" one is allowed in the INTERPOL implementation.

Valid Examples

```
<biom:ImageCategoryCode>FACE</biom:ImageCategoryCode>
```

11.6. Capture Organization (XML)

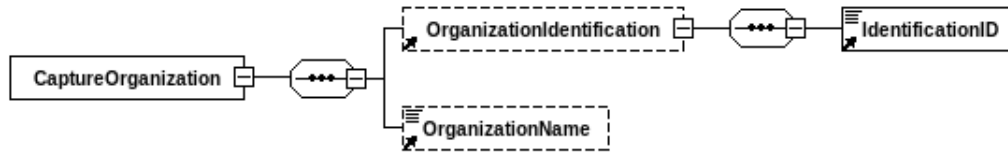

Field Reference: 10/SRC_10/SAN
Content Type: Set_X
XML Tag Name: CaptureOrganization
Data Type:
Minimum Length:
Minimum Occurrences: 1
Value range: *n/a*
Code table: *n/a*
Base type: nc:OrganizationType

Field ID: [10.004_10.993]
Condition: Mandatory
Defined in: xsd/niem/biometrics/1.0/biometrics.xsd
Special Characters: *n/a*
Maximum Length:
Maximum Occurrences: 1
Regular Expression: *n/a*
Namespace: <http://niem.gov/niem/biometrics/1.0>

XPath

```

if [10/IMT] IN "FACE" then
/it1:PackageFacialAndSMTImageRecord
  ↙/biom:FaceImage
    ↙/biom:ImageCaptureDetail
      ↙/biom:CaptureOrganization
else
/it1:PackageFacialAndSMTImageRecord
  ↙/biom:PhysicalFeatureImage
    ↙/biom:ImageCaptureDetail
      ↙/biom:CaptureOrganization
endif
  
```

Summary

Identifier of agency that created record and supplied information contained in it.

Notes

Applies to 10.004 and 10.993

11.7. Source Agency - SRC

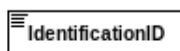

Field Reference: 10/SRC

Content Type: Data

XML Tag Name: IdentificationID

Data Type: U

Minimum Length: 1

Minimum Occurrences: 1

Value range: *n/a*

Code table: *n/a*

Base type: niem-xsd:string

Field ID: [10.004]

Condition: Mandatory

Defined in: xsd/niem/niem-core/2.0/niem-core.xsd

Special Characters: *n/a*

Maximum Length: *

Maximum Occurrences: 1

Regular Expression: *n/a*

Namespace: <http://niem.gov/niem/niem-core/2.0>

XPath

```

if [10/IMT] IN "FACE" then
/itl:PackageFacialAndSMTImageRecord
  ↙/biom:FaceImage
    ↙/biom:ImageCaptureDetail
      ↙/biom:CaptureOrganization
        ↙/nc:OrganizationIdentification
          ↙/nc:IdentificationID
else
/itl:PackageFacialAndSMTImageRecord
  ↙/biom:PhysicalFeatureImage
    ↙/biom:ImageCaptureDetail
      ↙/biom:CaptureOrganization
        ↙/nc:OrganizationIdentification
          ↙/nc:IdentificationID
endif

```

Summary

Identifier of agency that created and supplied information contained in the record. The source agency name may be entered in 10.993.

Valid Examples

```
<nc:IdentificationID>WI013415Y</nc:IdentificationID>
```

11.8. Photo Capture Date (XML) - PHD



Field Reference: 10/PHD:X
Content Type: Data_X
XML Tag Name: Date
Data Type: NS
Minimum Length: 10
Minimum Occurrences: 1
Value range: *n/a*
Code table: *n/a*
Base type: [niem-xsd:date](#)

Field ID: [10.005:X]
Condition: Mandatory
Defined in: [xsd/niem/niem-core/2.0/niem-core.xsd](#)
Special Characters: [-]
Maximum Length: 10
Maximum Occurrences: 1
Regular Expression: \d{4}-\d{2}-\d{2}
Namespace: <http://niem.gov/niem/niem-core/2.0>

XPath

```
if [10/IMT] IN "FACE" then
/itl:PackageFacialAndSMTImageRecord
  ↳/biom:FaceImage
    ↳/biom:ImageCaptureDetail
      ↳/biom:CaptureDate
        ↳/nc:Date
else
/itl:PackageFacialAndSMTImageRecord
  ↳/biom:PhysicalFeatureImage
    ↳/biom:ImageCaptureDetail
      ↳/biom:CaptureDate
        ↳/nc:Date
endif
```

Summary

The date that the image contained in the record was captured.

Valid Examples

```
<nc:Date>2007-01-01</nc:Date>
```

11.9. Horizontal Line Length - HLL

ImageHorizontalLineLengthPixelQuantity

Field Reference: 10/HLL

Content Type: Data

XML Tag Name: ImageHorizontalLineLengthPixelQuantity

Data Type: N

Minimum Length: 2

Minimum Occurrences: 1

Value range: {10..99999}

Code table: *n/a*

Base type: niem-xsd:integer

Field ID: [10.006]

Condition: Mandatory

Defined in: xsd/niem/biometrics/1.0/biometrics.xsd

Special Characters: *n/a*

Maximum Length: 5

Maximum Occurrences: 1

Regular Expression: *n/a*

Namespace: <http://niem.gov/niem/biometrics/1.0>

XPath

```
if [10/IMT] IN "FACE" then
/it1:PackageFacialAndSMTImageRecord
  ↙/biom:FaceImage
    ↙/biom:ImageHorizontalLineLengthPixelQuantity
else
/it1:PackageFacialAndSMTImageRecord
  ↙/biom:PhysicalFeatureImage
    ↙/biom:ImageHorizontalLineLengthPixelQuantity
endif
```

Summary

Number of pixels contained on a single horizontal line of the image.

Valid Examples

```
<biom:ImageHorizontalLineLengthPixelQuantity>80</biom:ImageHorizontalLineLengthPixelQuantity>
```

11.10. Vertical Line Length - VLL

 ImageVerticalLineLengthPixelQuantity
--

Field Reference: 10/VLL

Content Type: Data

XML Tag Name: ImageVerticalLineLengthPixelQuantity

Data Type: N

Minimum Length: 2

Minimum Occurrences: 1

Value range: {10..99999}

Code table: *n/a*

Base type: niem-xsd:integer

Field ID: [10.007]

Condition: Mandatory

Defined in: xsd/niem/biometrics/1.0/biometrics.xsd

Special Characters: *n/a*

Maximum Length: 5

Maximum Occurrences: 1

Regular Expression: *n/a*

Namespace: <http://niem.gov/niem/biometrics/1.0>

XPath

```
if [10/IMT] IN "FACE" then
/it1:PackageFacialAndSMTImageRecord
  ↙/biom:FaceImage
    ↙/biom:ImageVerticalLineLengthPixelQuantity
else
/it1:PackageFacialAndSMTImageRecord
  ↙/biom:PhysicalFeatureImage
    ↙/biom:ImageVerticalLineLengthPixelQuantity
endif
```

Summary

Number of pixels contained on a single vertical line of the image.

Valid Examples

<code><biom:ImageVerticalLineLengthPixelQuantity>65</biom:ImageVerticalLineLengthPixelQuantity></code>
--

11.11. Scale Units - SLC

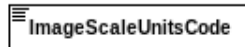

Field Reference: 10/SLC	Field ID: [10.008]
Content Type: Data	Condition: Mandatory
XML Tag Name: ImageScaleUnitsCode	Defined in: xsd/niem/biometrics/1.0/biometrics.xsd
Data Type: N	Special Characters: <i>n/a</i>
Minimum Length: 1	Maximum Length: 1
Minimum Occurrences: 1	Maximum Occurrences: 1
Value range: {0}	Regular Expression: <i>n/a</i>
Code table: see table A.59	
Base type: biom:ScaleUnitsCodeType	Namespace: http://niem.gov/niem/biometrics/1.0

XPath

```

if [10/IMT] IN "FACE" then
/itl:PackageFacialAndSMTImageRecord
  ↙/biom:FaceImage
    ↙/biom:ImageScaleUnitsCode
else
/itl:PackageFacialAndSMTImageRecord
  ↙/biom:PhysicalFeatureImage
    ↙/biom:ImageScaleUnitsCode
endif

```

Summary

Image sampling frequency (pixel density).

Notes

For contact exemplar friction ridge images, a value of 1 or 2 shall be specified. A value of 1 or 2 shall be specified for latent friction ridge prints if the lifted latent print is transmitted directly from a scanner. If the latent print is contained in a photograph, a value of 1 or 2 shall be entered only if the image of the latent was captured with a scale measurement visible in the image and the pixels across an inch or centimeter can be calculated - given the known characteristics of the camera and its distance from the latent print. A value of 0 for a latent print indicates that the true ppi value of the image is not known. For non-contact images of body parts, SLC shall be set to 0 unless the object being imaged is a fixed distance from the capture device and the ppi or ppm values for the capture device are accurately known at that fixed distance. (An example might be an iris capture device with a very small effective capture zone).

Valid Examples

```
<biom:ImageScaleUnitsCode>2</biom:ImageScaleUnitsCode>
```

11.12. Transmitted Horizontal Pixel Scale - THPS

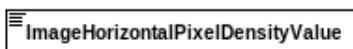

Field Reference: 10/THPS	Field ID: [10.009]
Content Type: Data	Condition: Mandatory
XML Tag Name: ImageHorizontalPixelDensityValue	Defined in: xsd/niem/biometrics/1.0/biometrics.xsd
Data Type: N	Special Characters: <i>n/a</i>
Minimum Length: 1	Maximum Length: 5
Minimum Occurrences: 1	Maximum Occurrences: 1
Value range: {10..99999}	Regular Expression: <i>n/a</i>
Code table: <i>n/a</i>	
Base type: niem-xsd:nonNegativeInteger	Namespace: http://niem.gov/niem/biometrics/1.0

XPath

```

if [10/IMT] IN "FACE" then
/itl:PackageFacialAndSMTImageRecord
  ↙/biom:FaceImage
    ↙/biom:ImageHorizontalPixelDensityValue
else
/itl:PackageFacialAndSMTImageRecord
  ↙/biom:PhysicalFeatureImage
    ↙/biom:ImageHorizontalPixelDensityValue
endif

```

Summary

Integer pixel density in the horizontal direction (if 10/SLC = 1 or 2); otherwise, if 10/SLC = 0, the horizontal component of the pixel aspect ratio.

Notes

For example, if the SLC value = 1, then the value of THPS could be '1000' for a 1000 ppi sensor.

Technical Notes

If 10/SLC=1,2, then THPS shall equal TVPS.

Valid Examples

```
<biom:ImageHorizontalPixelDensityValue>1000</biom:ImageHorizontalPixelDensityValue>
```

11.13. Transmitted Vertical Pixel Scale - TVPS

ImageVerticalPixelDensityValue

Field Reference: 10/TVPS	Field ID: [10.010]
Content Type: Data	Condition: Mandatory
XML Tag Name: ImageVerticalPixelDensityValue	Defined in: xsd/niem/biometrics/1.0/biometrics.xsd
Data Type: N	Special Characters: <i>n/a</i>
Minimum Length: 1	Maximum Length: 5
Minimum Occurrences: 1	Maximum Occurrences: 1
Value range: {10..99999}	Regular Expression: <i>n/a</i>
Code table: <i>n/a</i>	
Base type: niem-xsd:nonNegativeInteger	Namespace: http://niem.gov/niem/biometrics/1.0

XPath

```

if [10/IMT] IN "FACE" then
/itl:PackageFacialAndSMTImageRecord
  ↙/biom:FaceImage
    ↙/biom:ImageVerticalPixelDensityValue
else
/itl:PackageFacialAndSMTImageRecord
  ↙/biom:PhysicalFeatureImage
    ↙/biom:ImageVerticalPixelDensityValue
endif

```

Summary

Integer pixel density in the vertical direction (if 10/SLC = 1 or 2); otherwise, if 10/SLC = 0, the vertical component of the pixel aspect ratio.

Technical Notes

If 10/SLC=1,2, then THPS shall equal TVPS.

Valid Examples

```
<biom:ImageVerticalPixelDensityValue>1000</biom:ImageVerticalPixelDensityValue>
```

11.14. Compression Algorithm - CGA

 ImageCompressionAlgorithmText

Field Reference: 10/CGA

Content Type: Data

XML Tag Name: ImageCompressionAlgorithmText

Data Type: AN

Minimum Length: 3

Minimum Occurrences: 1

Value range: {"JPEGB", "JPEGL"}

Code table: see table A.6

Base type: nc:TextType

Field ID: [10.011]

Condition: Mandatory

Defined in: xsd/niem/biometrics/1.0/biometrics.xsd

Special Characters: *n/a*

Maximum Length: 5

Maximum Occurrences: 1

Regular Expression: *n/a*

Namespace: <http://niem.gov/niem/biometrics/1.0>

XPath

```

if [10/IMT] IN "FACE" then
/it1:PackageFacialAndSMTImageRecord
  ↙/biom:FaceImage
    ↙/biom:ImageCompressionAlgorithmText
else
/it1:PackageFacialAndSMTImageRecord
  ↙/biom:PhysicalFeatureImage
    ↙/biom:ImageCompressionAlgorithmText
endif
  
```

Summary

Algorithm used to compress the transmitted color or grayscale images.

Notes

INTERPOL standard restricts the possible formats to the following ones:

JPEGB JPEG lossy

JPEGL JPEG lossless

Valid Examples

```
<biom:ImageCompressionAlgorithmText>JPEGB</biom:ImageCompressionAlgorithmText>
```

11.15. Color Space - CSP

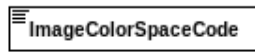

Field Reference: 10/CSP	Field ID: [10.012]
Content Type: Data	Condition: Mandatory
XML Tag Name: ImageColorSpaceCode	Defined in: xsd/niem/biometrics/1.0/biometrics.xsd
Data Type: A	Special Characters: <i>n/a</i>
Minimum Length: 3	Maximum Length: 4
Minimum Occurrences: 1	Maximum Occurrences: 1
Value range: {"SRGB"}	Regular Expression: <i>n/a</i>
Code table: see table A.14	
Base type: biom:ColorSpaceCodeType	Namespace: http://niem.gov/niem/biometrics/1.0

XPath

```
if [10/IMT] IN "FACE" then
/it1:PackageFacialAndSMTImageRecord
  ↙/biom:FaceImage
    ↙/biom:ImageColorSpaceCode
else
/it1:PackageFacialAndSMTImageRecord
  ↙/biom:PhysicalFeatureImage
    ↙/biom:ImageColorSpaceCode
endif
```

Summary

Image color space, e. g., grayscale or undetermined color space for an RGB image.

Notes

See Section 7.7.10.3 Color Image Data for a detailed description of this field.

Valid Examples

```
<biom:ImageColorSpaceCode>SRGB</biom:ImageColorSpaceCode>
```

11.16. Subject Acquisition Profile - SAP

FacelImageAcquisitionProfileCode

Field Reference: 10/SAP	Field ID: [10.013]
Content Type: Data	Condition: Dependent (see table)
XML Tag Name: FaceImageAcquisitionProfileCode	Defined in: xsd/niem/biometrics/1.0/biometrics.xsd
Data Type: N	Special Characters: <i>n/a</i>
Minimum Length: 1	Maximum Length: 2
Minimum Occurrences: 0	Maximum Occurrences: 1
Value range: {30..52}	Regular Expression: <i>n/a</i>
Code table: see table A.57	
Base type: biom:FaceImageAcquisitionProfileCodeType	Namespace: http://niem.gov/niem/biometrics/1.0

Dependency table

Type of dependency	Value
Mandatory on Value of other Field, should not be set if not.	[10/IMT]="FACE"

XPath

```
/it1:PackageFacialAndSMTImageRecord
  ↳/biom:FaceImage
    ↳/biom:FaceImageAcquisitionProfileCode
```

Summary

Set of characteristics concerning the capture of the face sample.

Notes

To ensure a minimum quality level, the Subject Acquisition Profile should be 30 or higher.

Valid Examples

<biom:FaceImageAcquisitionProfileCode>30</biom:FaceImageAcquisitionProfileCode>

11.17. Subject Pose - POS

 FacelImageSubjectPoseCode
--

Field Reference: 10/POS

Content Type: Data

XML Tag Name: FaceImageSubjectPoseCode

Data Type: A

Minimum Length: 1

Minimum Occurrences: 0

Value range: {"F","L","R","A"}

Code table: see table [A.47](#)

Base type: biom:SubjectPoseCodeType

Field ID: [10.020]

Condition: Dependent (see table)

Defined in: xsd/niem/biometrics/1.0/biometrics.xsd

Special Characters: *n/a*

Maximum Length: 1

Maximum Occurrences: 1

Regular Expression: *n/a*

Namespace: <http://niem.gov/niem/biometrics/1.0>

Dependency table

Type of dependency	Value
Optional on Value of other Field, should not be set otherwise.	[10/IMT]="FACE"

XPath

```
/it1:PackageFacialAndSMTImageRecord
  ↙/biom:FaceImage
    ↙/biom:FaceImageSubjectPoseCode
```

Summary

Code describing pose of subject.

Notes

For this implementation, the determined 3D pose is not permitted.

Valid Examples

<pre><biom:FaceImageSubjectPoseCode>F</biom:FaceImageSubjectPoseCode></pre>

11.18. Pose Offset Angle - POA

Field Reference: 10/POA

Content Type: Data

XML Tag Name: FaceImagePoseOffsetAngleMeasure

Data Type: NS

Minimum Length: 1

Minimum Occurrences: 0

Value range: {-180..180}

Code table: *n/a*

Base type: niem-xsd:integer

Field ID: [10.021]

Condition: Dependent (see table)

Defined in: xsd/niem/biometrics/1.0/biometrics.xsd

Special Characters: [-]

Maximum Length: 4

Maximum Occurrences: 1

Regular Expression: *n/a*

Namespace: <http://niem.gov/niem/biometrics/1.0>

Dependency table

Type of dependency	Value
Optional on Value of other Field, should not be set otherwise.	[10/IMT]="FACE",[10/POS]="A"

XPath

```
/it1:PackageFacialAndSMTImageRecord
  ↳/biom:FaceImage
    ↳/biom:FaceImagePoseOffsetAngleMeasure
```

Summary

Specifies pose direction of the subject to the nearest degree. A positive angle is used to express the angular offset as the subject rotates from a full-face pose to their left (approaching a right profile).

Valid Examples

```
<biom:FaceImagePoseOffsetAngleMeasure>40</biom:FaceImagePoseOffsetAngleMeasure>
```

11.19. Body Part Image - DATA

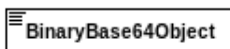

Field Reference: 10/DATA

Content Type: Data

XML Tag Name: BinaryBase64Object

Data Type: B

Minimum Length: 1

Minimum Occurrences: 1

Value range: *n/a*

Code table: *n/a*

Base type: niem-xsd:base64Binary

Field ID: [10.999]

Condition: Mandatory

Defined in: xsd/niem/niem-core/2.0/niem-core.xsd

Special Characters: *n/a*

Maximum Length: *

Maximum Occurrences: 1

Regular Expression: *n/a*

Namespace: <http://niem.gov/niem/niem-core/2.0>

XPath

```
if [10/IMT] IN "FACE" then
/itl:PackageFacialAndSMTImageRecord
  ↙/biom:FaceImage
    ↙/nc:BinaryBase64Object
else
/itl:PackageFacialAndSMTImageRecord
  ↙/biom:PhysicalFeatureImage
    ↙/nc:BinaryBase64Object
endif
```

Summary

Contains the image.

Notes

Binary for Traditional encoding or Base64 for XML

Valid Examples

```
<nc:BinaryBase64Object>mrHbPdrko3u1s7ahtgPBjtm01s85tfG2U7bpofY94Czu2SbY7d7wF9fQ7ZptgGrk02a2dsJ7wZbe8B1zvAmQ7xq+
Y94GoHeEsR3ikWd4DIGhmp3k42d4DRmzs94DKveDTB3hq6PeBLrtpPep0H/+h</nc:BinaryBase64Object>
```

11.20. Field Mandatoriness in Photographic Imagery Record

The following table shows a summary of the fields and information items in each record type and its corresponding XML elements, and in particular the fields and items that are mandatory.

Table 11.1.: Field Summary for Type 10 Records

Field Id	Code	Field Name	Card.	Notes
10/XRCC:X	[10.001:X]	XML Record Category Code	M	
10/IDC	[10.002]	Information Designation Character	M	
10/IMT_10/DATA	[10.003_10.999]	Face or Physical Feature Indication (XML)	M	
10/IMT	[10.003]	Image Type	M	
10/SRC_10/SAN	[10.004_10.993]	Capture Organization (XML)	M	
10/SRC	[10.004]	Source Agency	M	
10/PHD:X	[10.005:X]	Photo Capture Date (XML)	M	
10/HLL	[10.006]	Horizontal Line Length	M	
10/VLL	[10.007]	Vertical Line Length	M	
10/SLC	[10.008]	Scale Units	M	
10/THPS	[10.009]	Transmitted Horizontal Pixel Scale	M	
10/TVPS	[10.010]	Transmitted Vertical Pixel Scale	M	
10/CGA	[10.011]	Compression Algorithm	M	
10/CSP	[10.012]	Color Space	M	
10/SAP	[10.013]	Subject Acquisition Profile	D	This field is required (and not permitted otherwise) if [10/IMT]="FACE"
10/POS	[10.020]	Subject Pose	D	This field is optional (and should not be entered otherwise) if [10/IMT]="FACE"
10/POA	[10.021]	Pose Offset Angle	D	This field is optional (and should not be entered otherwise) if [10/IMT]="FACE", [10/POS]="A"
10/DATA	[10.999]	Body Part Image	M	

M=Mandatory, O=Optional, M^=Mandatory Info Item within a Field, O^=Optional Info Item within a Field, D=Dependent on other Fields/Info Items

12. Friction-ridge Latent Image Record (aka Type 13)

This chapter describes all the fields that are used in the Friction-ridge Latent Image Record.

12.1. Package Latent Image Record (XML)

Field Reference: 13
Content Type: Set_X
XML Tag Name: PackageLatentImageRecord
Data Type:
Minimum Length:
Minimum Occurrences: 0
Value range: *n/a*
Code table: *n/a*
Base type: itl:PackageLatentImageRecordType

Field ID: [13]
Condition: Optional
Defined in: xsd/itl/2011/ITL-2007f-Package.xsd
Special Characters: *n/a*
Maximum Length:
Maximum Occurrences: *
Regular Expression: *n/a*
Namespace: <http://biometrics.nist.gov/standard/2011>

XPath

/itl:PackageLatentImageRecord

Summary

Image data acquired from latent captures of friction ridge images.

12. Friction-ridge Latent Image Record (aka Type 13)



12.2. XML Record Category Code - XRCC

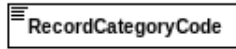

Field Reference: 13/XRCC:X
Content Type: Data_X
XML Tag Name: RecordCategoryCode
Data Type: N
Minimum Length: 1
Minimum Occurrences: 1
Value range: {13}
Code table: *n/a*
Base type: biom:RecordCategoryCodeType

Field ID: [13.001:X]
Condition: Mandatory
Defined in: xsd/niem/biometrics/1.0/biometrics.xsd
Special Characters: *n/a*
Maximum Length: 2
Maximum Occurrences: 1
Regular Expression: *n/a*
Namespace: <http://niem.gov/niem/biometrics/1.0>

XPath

```
/it1:PackageLatentImageRecord  
  ↘/biom:RecordCategoryCode
```

Summary

Numeric representation of Record Type.

Valid Examples

```
<biom:RecordCategoryCode>13</biom:RecordCategoryCode>
```

12.3. Information Designation Character - IDC

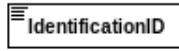

Field Reference: 13/IDC

Content Type: Data

XML Tag Name: IdentificationID

Data Type: N

Minimum Length: 1

Minimum Occurrences: 1

Value range: {0..99}

Code table: *n/a*

Base type: niem-xsd:string

Field ID: [13.002]

Condition: Mandatory

Defined in: xsd/niem/niem-core/2.0/niem-core.xsd

Special Characters: *n/a*

Maximum Length: 2

Maximum Occurrences: 1

Regular Expression: *n/a*

Namespace: <http://niem.gov/niem/niem-core/2.0>

XPath

```
/it1:PackageLatentImageRecord  
  ↙/biom:ImageReferenceIdentification  
    ↙/nc:IdentificationID
```

Summary

IDC assigned to this Type-13 record as listed in 1.003.

Valid Examples

```
<nc:IdentificationID>6</nc:IdentificationID>
```

12.4. Image Type (XML)

Field Reference: 13/IMP_13/DATA

Content Type: Set_X

XML Tag Name: FingerImpressionImage or FrictionRidgeImage or PalmprintImage or PlantarImage

Data Type:

Minimum Length:

Minimum Occurrences: 1

Value range: *n/a*

Code table: *n/a*

Base type: biom:FrictionRidgeImageType or biom:PalmprintImageType or biom:PlantarImageType or biom:FingerImpressionImageType

Field ID: [13.003_13.999]

Condition: Mandatory

Defined in: xsd/niem/biometrics/1.0/biometrics.xsd

Special Characters: *n/a*

Maximum Length:

Maximum Occurrences: 1

Regular Expression: *n/a*

Namespace: <http://niem.gov/niem/biometrics/1.0>

XPath

```

if [13/IMP] IN 4..7 then
/itl:PackageLatentImageRecord
  \biom:FingerImpressionImage
or
/itl:PackageLatentImageRecord
  \biom:FrictionRidgeImage
elseif [13/IMP] IN 12..15 then
/itl:PackageLatentImageRecord
  \biom:PalmprintImage
or
/itl:PackageLatentImageRecord
  \biom:FrictionRidgeImage
elseif [13/IMP] IN 28, 29 then
/itl:PackageLatentImageRecord
  \biom:FingerImpressionImage
or
/itl:PackageLatentImageRecord
  \biom:PalmprintImage
or
/itl:PackageLatentImageRecord
  \biom:PlantarImage
or
/itl:PackageLatentImageRecord
  \biom:FrictionRidgeImage
elseif [13/IMP] IN 32..35 then
/itl:PackageLatentImageRecord
  \biom:PlantarImage
or
/itl:PackageLatentImageRecord
  \biom:FrictionRidgeImage
else
/itl:PackageLatentImageRecord
  \biom:FrictionRidgeImage
endif

```

Summary

Image and associated information.

Notes

Applies to 13.003, 13.004, 13.005, 13.006, 13.007, 13.008, 13.009, 13.010, 13.011, 13.012, 13.013, 13.014, 13.015, 13.016, 13.017, 13.020, 13.024, 13.903, 13.904, 13.993, 13.998, 13.999. XML elements itl:FingerprintImage and itl:PalmprintImage are not listed in ANSI/NIST documentation, but are included in the XML schemas to allow for backward compatibility.

12.5. Impression Type - IMP

 FingerprintImageImpressionCaptureCategoryCode
--

Field Reference: 13/IMP

Content Type: Data

XML Tag Name: FingerprintImageImpressionCaptureCategoryCode

Data Type: N

Minimum Length: 1

Minimum Occurrences: 1

Value range: {4}

Code table: see table A.31

Base type: biom:ImpressionCaptureCategoryCodeType

Field ID: [13.003]

Condition: Mandatory

Defined in: xsd/niem/biometrics/1.0/biometrics.xsd

Special Characters: *n/a*

Maximum Length: 2

Maximum Occurrences: 1

Regular Expression: *n/a*

Namespace: <http://niem.gov/niem/biometrics/1.0>

XPath

```

if [13/IMP] IN 4..7 then
/itl:PackageLatentImageRecord
  ↳/biom:FingerImpressionImage
or
  ↳/biom:FingerprintImageImpressionCaptureCategoryCode
or
/itl:PackageLatentImageRecord
  ↳/biom:FrictionRidgeImage
  ↳/biom:FingerprintImageImpressionCaptureCategoryCode
elseif [13/IMP] IN 12..15 then
/itl:PackageLatentImageRecord
  ↳/biom:PalmpointImage
  ↳/biom:FingerprintImageImpressionCaptureCategoryCode
or
/itl:PackageLatentImageRecord
  ↳/biom:FrictionRidgeImage
  ↳/biom:FingerprintImageImpressionCaptureCategoryCode
elseif [13/IMP] IN 28, 29 then
/itl:PackageLatentImageRecord
  ↳/biom:FingerImpressionImage
  ↳/biom:FingerprintImageImpressionCaptureCategoryCode
/itl:PackageLatentImageRecord
  ↳/biom:PalmpointImage
  ↳/biom:FingerprintImageImpressionCaptureCategoryCode
or
/itl:PackageLatentImageRecord
  ↳/biom:PlantarImage
  ↳/biom:FingerprintImageImpressionCaptureCategoryCode
or
/itl:PackageLatentImageRecord
  ↳/biom:FrictionRidgeImage
  ↳/biom:FingerprintImageImpressionCaptureCategoryCode
elseif [13/IMP] IN 32..35 then
/itl:PackageLatentImageRecord
  ↳/biom:PlantarImage
  ↳/biom:FingerprintImageImpressionCaptureCategoryCode
or
/itl:PackageLatentImageRecord
  ↳/biom:FrictionRidgeImage
  ↳/biom:FingerprintImageImpressionCaptureCategoryCode
else

```

12. Friction-ridge Latent Image Record (aka Type 13)

```
/it1:PackageLatentImageRecord
  ↪/biom:FrictionRidgeImage
    ↪/biom:FingerprintImageImpressionCaptureCategoryCode
endif
```

Summary

Manner by which latent print was obtained.

Valid Examples

```
<biom:FingerprintImageImpressionCaptureCategoryCode>5</biom:FingerprintImageImpressionCaptureCategoryCode>
```

12.6. Capture Organization (XML)

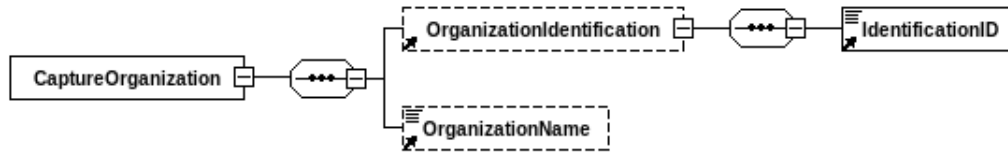

Field Reference: 13/SRC_13/SAN
Content Type: Set_X
XML Tag Name: CaptureOrganization
Data Type:
Minimum Length:
Minimum Occurrences: 1
Value range: *n/a*
Code table: *n/a*
Base type: nc:OrganizationType

Field ID: [13.004_13.993]
Condition: Mandatory
Defined in: xsd/niem/biometrics/1.0/biometrics.xsd
Special Characters: *n/a*
Maximum Length:
Maximum Occurrences: 1
Regular Expression: *n/a*
Namespace: <http://niem.gov/niem/biometrics/1.0>

XPath

```

if [13/IMP] IN 4..7 then
/itl:PackageLatentImageRecord
  ↳/biom:FingerImpressionImage
    ↳/biom:ImageCaptureDetail
      ↳/biom:CaptureOrganization
or
/itl:PackageLatentImageRecord
  ↳/biom:FrictionRidgeImage
    ↳/biom:ImageCaptureDetail
      ↳/biom:CaptureOrganization
elseif [13/IMP] IN 12..15 then
/itl:PackageLatentImageRecord
  ↳/biom:PalmpointImage
    ↳/biom:ImageCaptureDetail
      ↳/biom:CaptureOrganization
or
/itl:PackageLatentImageRecord
  ↳/biom:FrictionRidgeImage
    ↳/biom:ImageCaptureDetail
      ↳/biom:CaptureOrganization
elseif [13/IMP] IN 28, 29 then
/itl:PackageLatentImageRecord
  ↳/biom:FingerImpressionImage
    ↳/biom:ImageCaptureDetail
      ↳/biom:CaptureOrganization
or
/itl:PackageLatentImageRecord
  ↳/biom:PalmpointImage
    ↳/biom:ImageCaptureDetail
      ↳/biom:CaptureOrganization
or
/itl:PackageLatentImageRecord
  ↳/biom:PlantarImage
    ↳/biom:ImageCaptureDetail
      ↳/biom:CaptureOrganization
or
  
```



```
/itl:PackageLatentImageRecord
  ↳/biom:FrictionRidgeImage
    ↳/biom:ImageCaptureDetail
      ↳/biom:CaptureOrganization
elseif [13/IMP] IN 32..35 then
/itl:PackageLatentImageRecord
  ↳/biom:PlantarImage
    ↳/biom:ImageCaptureDetail
      ↳/biom:CaptureOrganization
or
/itl:PackageLatentImageRecord
  ↳/biom:FrictionRidgeImage
    ↳/biom:ImageCaptureDetail
      ↳/biom:CaptureOrganization
else
/itl:PackageLatentImageRecord
  ↳/biom:FrictionRidgeImage
    ↳/biom:ImageCaptureDetail
      ↳/biom:CaptureOrganization
endif
```

Summary

Identifier of agency that created record and supplied information contained in it.

Notes

Applies to 13.004 and 13.993.

12.7. Source Agency - SRC

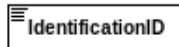

Field Reference: 13/SRC

Content Type: Data

XML Tag Name: IdentificationID

Data Type: U

Minimum Length: 1

Minimum Occurrences: 1

Value range: *n/a*

Code table: *n/a*

Base type: niem-xsd:string

Field ID: [13.004]

Condition: Mandatory

Defined in: xsd/niem/niem-core/2.0/niem-core.xsd

Special Characters: *n/a*

Maximum Length: *

Maximum Occurrences: 1

Regular Expression: *n/a*

Namespace: <http://niem.gov/niem/niem-core/2.0>

XPath

```

if [13/IMP] IN 4..7 then
/itl:PackageLatentImageRecord
  ↘/biom:FingerImpressionImage
    ↘/biom:ImageCaptureDetail
      ↘/biom:CaptureOrganization
        ↘/nc:OrganizationIdentification
          ↘/nc:IdentificationID
or
/itl:PackageLatentImageRecord
  ↘/biom:FrictionRidgeImage
    ↘/biom:ImageCaptureDetail
      ↘/biom:CaptureOrganization
        ↘/nc:OrganizationIdentification
          ↘/nc:IdentificationID
elseif [13/IMP] IN 12..15 then
/itl:PackageLatentImageRecord
  ↘/biom:PalmpointImage
    ↘/biom:ImageCaptureDetail
      ↘/biom:CaptureOrganization
        ↘/nc:OrganizationIdentification
          ↘/nc:IdentificationID
or
/itl:PackageLatentImageRecord
  ↘/biom:FrictionRidgeImage
    ↘/biom:ImageCaptureDetail
      ↘/biom:CaptureOrganization
        ↘/nc:OrganizationIdentification
          ↘/nc:IdentificationID
elseif [13/IMP] IN 28, 29 then
/itl:PackageLatentImageRecord
  ↘/biom:FingerImpressionImage
    ↘/biom:ImageCaptureDetail
      ↘/biom:CaptureOrganization
        ↘/nc:OrganizationIdentification
          ↘/nc:IdentificationID
or
/itl:PackageLatentImageRecord
  ↘/biom:PalmpointImage
    ↘/biom:ImageCaptureDetail
      ↘/biom:CaptureOrganization
        ↘/nc:OrganizationIdentification
          ↘/nc:IdentificationID

```

```

or
/itl:PackageLatentImageRecord
  ↪/biom:PlantarImage
    ↪/biom:ImageCaptureDetail
      ↪/biom:CaptureOrganization
        ↪/nc:OrganizationIdentification
          ↪/nc:IdentificationID
or
/itl:PackageLatentImageRecord
  ↪/biom:FrictionRidgeImage
    ↪/biom:ImageCaptureDetail
      ↪/biom:CaptureOrganization
        ↪/nc:OrganizationIdentification
          ↪/nc:IdentificationID
elseif [13/IMP] IN 32..35 then
/itl:PackageLatentImageRecord
  ↪/biom:PlantarImage
    ↪/biom:ImageCaptureDetail
      ↪/biom:CaptureOrganization
        ↪/nc:OrganizationIdentification
          ↪/nc:IdentificationID
or
/itl:PackageLatentImageRecord
  ↪/biom:FrictionRidgeImage
    ↪/biom:ImageCaptureDetail
      ↪/biom:CaptureOrganization
        ↪/nc:OrganizationIdentification
          ↪/nc:IdentificationID
else
/itl:PackageLatentImageRecord
  ↪/biom:FrictionRidgeImage
    ↪/biom:ImageCaptureDetail
      ↪/biom:CaptureOrganization
        ↪/nc:OrganizationIdentification
          ↪/nc:IdentificationID
endif

```

Summary

Identifier of agency that created and supplied information contained in the record. The source agency name may be entered in 13.993.

Valid Examples

<nc:IdentificationID>WI013415Y</nc:IdentificationID>
--

12.8. Latent Capture Date (XML) - LCD



Field Reference: 13/LCD:X
Content Type: Data_X
XML Tag Name: Date
Data Type: NS
Minimum Length: 10
Minimum Occurrences: 1
Value range: *n/a*
Code table: *n/a*
Base type: [niem-xsd:date](#)

Field ID: [13.005:X]
Condition: Mandatory
Defined in: [xsd/niem/niem-core/2.0/niem-core.xsd](#)
Special Characters: [-]
Maximum Length: 10
Maximum Occurrences: 1
Regular Expression: \d{4}-\d{2}-\d{2}
Namespace: <http://niem.gov/niem/niem-core/2.0>

XPath

```

if [13/IMP] IN 4..7 then
/itl:PackageLatentImageRecord
  ↳/biom:FingerImpressionImage
    ↳/biom:ImageCaptureDetail
      ↳/biom:CaptureDate
        ↳/nc:Date
or
/itl:PackageLatentImageRecord
  ↳/biom:FrictionRidgeImage
    ↳/biom:ImageCaptureDetail
      ↳/biom:CaptureDate
        ↳/nc:Date
elseif [13/IMP] IN 12..15 then
/itl:PackageLatentImageRecord
  ↳/biom:PalmpointImage
    ↳/biom:ImageCaptureDetail
      ↳/biom:CaptureDate
        ↳/nc:Date
or
/itl:PackageLatentImageRecord
  ↳/biom:FrictionRidgeImage
    ↳/biom:ImageCaptureDetail
      ↳/biom:CaptureDate
        ↳/nc:Date
elseif [13/IMP] IN 28, 29 then
/itl:PackageLatentImageRecord
  ↳/biom:FingerImpressionImage
    ↳/biom:ImageCaptureDetail
      ↳/biom:CaptureDate
        ↳/nc:Date
or
/itl:PackageLatentImageRecord
  ↳/biom:PalmpointImage
    ↳/biom:ImageCaptureDetail
      ↳/biom:CaptureDate
        ↳/nc:Date
or
/itl:PackageLatentImageRecord
  ↳/biom:PlantarImage
    ↳/biom:ImageCaptureDetail
      ↳/biom:CaptureDate
        ↳/nc:Date

```

```
or
/itl:PackageLatentImageRecord
  ↪/biom:FrictionRidgeImage
    ↪/biom:ImageCaptureDetail
      ↪/biom:CaptureDate
        ↪/nc:Date
elseif [13/IMP] IN 32..35 then
/itl:PackageLatentImageRecord
  ↪/biom:PlantarImage
    ↪/biom:ImageCaptureDetail
      ↪/biom:CaptureDate
        ↪/nc:Date
or
/itl:PackageLatentImageRecord
  ↪/biom:FrictionRidgeImage
    ↪/biom:ImageCaptureDetail
      ↪/biom:CaptureDate
        ↪/nc:Date
else
/itl:PackageLatentImageRecord
  ↪/biom:FrictionRidgeImage
    ↪/biom:ImageCaptureDetail
      ↪/biom:CaptureDate
        ↪/nc:Date
endif
```

Summary

Capture date of latent biometric data.

Valid Examples

```
<nc:Date>2014-01-18</nc:Date>
```

12.9. Horizontal Line Length - HLL

ImageHorizontalLineLengthPixelQuantity
--

Field Reference: 13/HLL

Content Type: Data

XML Tag Name: ImageHorizontalLineLengthPixelQuantity

Data Type: N

Minimum Length: 2

Minimum Occurrences: 1

Value range: {10..99999}

Code table: *n/a*

Base type: niem-xsd:integer

Field ID: [13.006]

Condition: Mandatory

Defined in: xsd/niem/biometrics/1.0/biometrics.xsd

Special Characters: *n/a*

Maximum Length: 5

Maximum Occurrences: 1

Regular Expression: *n/a*

Namespace: <http://niem.gov/niem/biometrics/1.0>

XPath

```

if [13/IMP] IN 4..7 then
/itl:PackageLatentImageRecord
  ↳/biom:FingerImpressionImage
    ↳/biom:ImageHorizontalLineLengthPixelQuantity
or
/itl:PackageLatentImageRecord
  ↳/biom:FrictionRidgeImage
    ↳/biom:ImageHorizontalLineLengthPixelQuantity
elseif [13/IMP] IN 12..15 then
/itl:PackageLatentImageRecord
  ↳/biom:PalmprintImage
    ↳/biom:ImageHorizontalLineLengthPixelQuantity
or
/itl:PackageLatentImageRecord
  ↳/biom:FrictionRidgeImage
    ↳/biom:ImageHorizontalLineLengthPixelQuantity
elseif [13/IMP] IN 28, 29 then
/itl:PackageLatentImageRecord
  ↳/biom:FingerImpressionImage
    ↳/biom:ImageHorizontalLineLengthPixelQuantity
or
/itl:PackageLatentImageRecord
  ↳/biom:PalmprintImage
    ↳/biom:ImageHorizontalLineLengthPixelQuantity
or
/itl:PackageLatentImageRecord
  ↳/biom:PlantarImage
    ↳/biom:ImageHorizontalLineLengthPixelQuantity
or
/itl:PackageLatentImageRecord
  ↳/biom:FrictionRidgeImage
    ↳/biom:ImageHorizontalLineLengthPixelQuantity
elseif [13/IMP] IN 32..35 then
/itl:PackageLatentImageRecord
  ↳/biom:PlantarImage
    ↳/biom:ImageHorizontalLineLengthPixelQuantity
or
/itl:PackageLatentImageRecord
  ↳/biom:FrictionRidgeImage
    ↳/biom:ImageHorizontalLineLengthPixelQuantity
else

```

12. Friction-ridge Latent Image Record (aka Type 13)

```
/itl:PackageLatentImageRecord
  ↪/biom:FrictionRidgeImage
    ↪/biom:ImageHorizontalLineLengthPixelQuantity
endif
```

Summary

Number of pixels contained on a single horizontal line of the image.

Valid Examples

```
<biom:ImageHorizontalLineLengthPixelQuantity>80</biom:ImageHorizontalLineLengthPixelQuantity>
```

12.10. Vertical Line Length - VLL

ImageVerticalLineLengthPixelQuantity

Field Reference: 13/VLL

Content Type: Data

XML Tag Name: ImageVerticalLineLengthPixelQuantity

Data Type: N

Minimum Length: 2

Minimum Occurrences: 1

Value range: {10..99999}

Code table: *n/a*

Base type: niem-xsd:integer

Field ID: [13.007]

Condition: Mandatory

Defined in: xsd/niem/biometrics/1.0/biometrics.xsd

Special Characters: *n/a*

Maximum Length: 5

Maximum Occurrences: 1

Regular Expression: *n/a*

Namespace: <http://niem.gov/niem/biometrics/1.0>

XPath

```

if [13/IMP] IN 4..7 then
/itl:PackageLatentImageRecord
  ↘/biom:FingerImpressionImage
    ↘/biom:ImageVerticalLineLengthPixelQuantity
or
/itl:PackageLatentImageRecord
  ↘/biom:FrictionRidgeImage
    ↘/biom:ImageVerticalLineLengthPixelQuantity
elseif [13/IMP] IN 12..15 then
/itl:PackageLatentImageRecord
  ↘/biom:PalmpointImage
    ↘/biom:ImageVerticalLineLengthPixelQuantity
or
/itl:PackageLatentImageRecord
  ↘/biom:FrictionRidgeImage
    ↘/biom:ImageVerticalLineLengthPixelQuantity
elseif [13/IMP] IN 28, 29 then
/itl:PackageLatentImageRecord
  ↘/biom:FingerImpressionImage
    ↘/biom:ImageVerticalLineLengthPixelQuantity
or
/itl:PackageLatentImageRecord
  ↘/biom:PalmpointImage
    ↘/biom:ImageVerticalLineLengthPixelQuantity
or
/itl:PackageLatentImageRecord
  ↘/biom:PlantarImage
    ↘/biom:ImageVerticalLineLengthPixelQuantity
or
/itl:PackageLatentImageRecord
  ↘/biom:FrictionRidgeImage
    ↘/biom:ImageVerticalLineLengthPixelQuantity
elseif [13/IMP] IN 32..35 then
/itl:PackageLatentImageRecord
  ↘/biom:PlantarImage
    ↘/biom:ImageVerticalLineLengthPixelQuantity
or
/itl:PackageLatentImageRecord
  ↘/biom:FrictionRidgeImage
    ↘/biom:ImageVerticalLineLengthPixelQuantity
else

```

12. Friction-ridge Latent Image Record (aka Type 13)

```
/itl:PackageLatentImageRecord
  ↪/biom:FrictionRidgeImage
    ↪/biom:ImageVerticalLineLengthPixelQuantity
endif
```

Summary

Number of pixels contained on a single vertical line of the image.

Valid Examples

```
<biom:ImageVerticalLineLengthPixelQuantity>65</biom:ImageVerticalLineLengthPixelQuantity>
```

12.11. Scale Units - SLC

 ImageScaleUnitsCode

<p>Field Reference: 13/SLC</p> <p>Content Type: Data</p> <p>XML Tag Name: ImageScaleUnitsCode</p> <p>Data Type: N</p> <p>Minimum Length: 1</p> <p>Minimum Occurrences: 1</p> <p>Value range: {1..2}</p> <p>Code table: see table A.59</p> <p>Base type: biom:ScaleUnitsCodeType</p>	<p>Field ID: [13.008]</p> <p>Condition: Mandatory</p> <p>Defined in: xsd/niem/biometrics/1.0/biometrics.xsd</p> <p>Special Characters: <i>n/a</i></p> <p>Maximum Length: 1</p> <p>Maximum Occurrences: 1</p> <p>Regular Expression: <i>n/a</i></p> <p>Namespace: http://niem.gov/niem/biometrics/1.0</p>
--	--

XPath

```

if [13/IMP] IN 4..7 then
/itl:PackageLatentImageRecord
  ↳/biom:FingerImpressionImage
    ↳/biom:ImageScaleUnitsCode
or
/itl:PackageLatentImageRecord
  ↳/biom:FrictionRidgeImage
    ↳/biom:ImageScaleUnitsCode
elseif [13/IMP] IN 12..15 then
/itl:PackageLatentImageRecord
  ↳/biom:PalmpointImage
    ↳/biom:ImageScaleUnitsCode
or
/itl:PackageLatentImageRecord
  ↳/biom:FrictionRidgeImage
    ↳/biom:ImageScaleUnitsCode
elseif [13/IMP] IN 28, 29 then
/itl:PackageLatentImageRecord
  ↳/biom:FingerImpressionImage
    ↳/biom:ImageScaleUnitsCode
or
/itl:PackageLatentImageRecord
  ↳/biom:PalmpointImage
    ↳/biom:ImageScaleUnitsCode
or
/itl:PackageLatentImageRecord
  ↳/biom:PlantarImage
    ↳/biom:ImageScaleUnitsCode
or
/itl:PackageLatentImageRecord
  ↳/biom:FrictionRidgeImage
    ↳/biom:ImageScaleUnitsCode
elseif [13/IMP] IN 32..35 then
/itl:PackageLatentImageRecord
  ↳/biom:PlantarImage
    ↳/biom:ImageScaleUnitsCode
or
/itl:PackageLatentImageRecord
  ↳/biom:FrictionRidgeImage
    ↳/biom:ImageScaleUnitsCode
else
/itl:PackageLatentImageRecord
  ↳/biom:FrictionRidgeImage
    ↳/biom:ImageScaleUnitsCode

```

endif

Summary

Image sampling frequency (pixel density).

Notes

For contact exemplar friction ridge images, a value of 1 or 2 shall be specified. A value of 1 or 2 shall be specified for latent friction ridge prints if the lifted latent print is transmitted directly from a scanner. If the latent print is contained in a photograph, a value of 1 or 2 shall be entered only if the image of the latent was captured with a scale measurement visible in the image and the pixels across an inch or centimeter can be calculated - given the known characteristics of the camera and its distance from the latent print. A value of 0 for a latent print indicates that the true ppi value of the image is not known. For non-contact images of body parts, SLC shall be set to 0 unless the object being imaged is a fixed distance from the capture device and the ppi or ppm values for the capture device are accurately known at that fixed distance. (An example might be an iris capture device with a very small effective capture zone).

Valid Examples

```
<biom:ImageScaleUnitsCode>1</biom:ImageScaleUnitsCode>
```

12.12. Transmitted Horizontal Pixel Scale - THPS

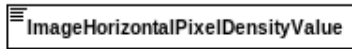

Field Reference: 13/THPS	Field ID: [13.009]
Content Type: Data	Condition: Mandatory
XML Tag Name: ImageHorizontalPixelDensityValue	Defined in: xsd/niem/biometrics/1.0/biometrics.xsd
Data Type: N	Special Characters: <i>n/a</i>
Minimum Length: 1	Maximum Length: 5
Minimum Occurrences: 1	Maximum Occurrences: 1
Value range: <i>n/a</i>	Regular Expression: <i>n/a</i>
Code table: <i>n/a</i>	
Base type: niem-xsd:nonNegativeInteger	Namespace: http://niem.gov/niem/biometrics/1.0

XPath

```

if [13/IMP] IN 4..7 then
/itl:PackageLatentImageRecord
  ↳/biom:FingerImpressionImage
    ↳/biom:ImageCaptureDetail
      ↳/biom:ImageHorizontalPixelDensityValue
or
/itl:PackageLatentImageRecord
  ↳/biom:FrictionRidgeImage
    ↳/biom:ImageCaptureDetail
      ↳/biom:ImageHorizontalPixelDensityValue
elseif [13/IMP] IN 12..15 then
/itl:PackageLatentImageRecord
  ↳/biom:PalmpointImage
    ↳/biom:ImageCaptureDetail
      ↳/biom:ImageHorizontalPixelDensityValue
or
/itl:PackageLatentImageRecord
  ↳/biom:FrictionRidgeImage
    ↳/biom:ImageCaptureDetail
      ↳/biom:ImageHorizontalPixelDensityValue
elseif [13/IMP] IN 28, 29 then
/itl:PackageLatentImageRecord
  ↳/biom:FingerImpressionImage
    ↳/biom:ImageCaptureDetail
      ↳/biom:ImageHorizontalPixelDensityValue
or
/itl:PackageLatentImageRecord
  ↳/biom:PalmpointImage
    ↳/biom:ImageCaptureDetail
      ↳/biom:ImageHorizontalPixelDensityValue
or
/itl:PackageLatentImageRecord
  ↳/biom:PlantarImage
    ↳/biom:ImageCaptureDetail
      ↳/biom:ImageHorizontalPixelDensityValue
or
/itl:PackageLatentImageRecord
  ↳/biom:FrictionRidgeImage
    ↳/biom:ImageCaptureDetail
      ↳/biom:ImageHorizontalPixelDensityValue
elseif [13/IMP] IN 32..35 then

```

12. Friction-ridge Latent Image Record (aka Type 13)

```
/itl:PackageLatentImageRecord
  ↪/biom:PlantarImage
    ↪/biom:ImageCaptureDetail
      ↪/biom:ImageHorizontalPixelDensityValue
or
/itl:PackageLatentImageRecord
  ↪/biom:FrictionRidgeImage
    ↪/biom:ImageCaptureDetail
      ↪/biom:ImageHorizontalPixelDensityValue
else
/itl:PackageLatentImageRecord
  ↪/biom:FrictionRidgeImage
    ↪/biom:ImageCaptureDetail
      ↪/biom:ImageHorizontalPixelDensityValue
endif
```

Summary

Integer pixel density in the horizontal direction (if 13/SLC = 1 or 2); otherwise, if 13/SLC = 0, the horizontal component of the pixel aspect ratio.

Notes

For example, if the SLC value = 1, then the value of THPS could be '1000' for a 1000 ppi sensor.

Technical Notes

If 13/SLC=1,2, then THPS shall equal TVPS.

Valid Examples

```
<biom:ImageHorizontalPixelDensityValue>1000</biom:ImageHorizontalPixelDensityValue>
```

12.13. Transmitted Vertical Pixel Scale - TVPS

ImageVerticalPixelDensityValue

Field Reference: 13/TVPS

Content Type: Data

XML Tag Name: ImageVerticalPixelDensityValue

Data Type: N

Minimum Length: 1

Minimum Occurrences: 1

Value range: *n/a*

Code table: *n/a*

Base type: niem-xsd:nonNegativeInteger

Field ID: [13.010]

Condition: Mandatory

Defined in: xsd/niem/biometrics/1.0/biometrics.xsd

Special Characters: *n/a*

Maximum Length: 5

Maximum Occurrences: 1

Regular Expression: *n/a*

Namespace: <http://niem.gov/niem/biometrics/1.0>

XPath

```

if [13/IMP] IN 4..7 then
/itl:PackageLatentImageRecord
  ↳/biom:FingerImpressionImage
    ↳/biom:ImageCaptureDetail
      ↳/biom:ImageVerticalPixelDensityValue
or
/itl:PackageLatentImageRecord
  ↳/biom:FrictionRidgeImage
    ↳/biom:ImageCaptureDetail
      ↳/biom:ImageVerticalPixelDensityValue
elseif [13/IMP] IN 12..15 then
/itl:PackageLatentImageRecord
  ↳/biom:PalmpointImage
    ↳/biom:ImageCaptureDetail
      ↳/biom:ImageVerticalPixelDensityValue
or
/itl:PackageLatentImageRecord
  ↳/biom:FrictionRidgeImage
    ↳/biom:ImageCaptureDetail
      ↳/biom:ImageVerticalPixelDensityValue
elseif [13/IMP] IN 28, 29 then
/itl:PackageLatentImageRecord
  ↳/biom:FingerImpressionImage
    ↳/biom:ImageCaptureDetail
      ↳/biom:ImageVerticalPixelDensityValue
or
/itl:PackageLatentImageRecord
  ↳/biom:PalmpointImage
    ↳/biom:ImageCaptureDetail
      ↳/biom:ImageVerticalPixelDensityValue
or
/itl:PackageLatentImageRecord
  ↳/biom:PlantarImage
    ↳/biom:ImageCaptureDetail
      ↳/biom:ImageVerticalPixelDensityValue
or
/itl:PackageLatentImageRecord
  ↳/biom:FrictionRidgeImage
    ↳/biom:ImageCaptureDetail
      ↳/biom:ImageVerticalPixelDensityValue
elseif [13/IMP] IN 32..35 then

```

```
/itl:PackageLatentImageRecord
  ↳/biom:PlantarImage
    ↳/biom:ImageCaptureDetail
      ↳/biom:ImageVerticalPixelDensityValue
or
/itl:PackageLatentImageRecord
  ↳/biom:FrictionRidgeImage
    ↳/biom:ImageCaptureDetail
      ↳/biom:ImageVerticalPixelDensityValue
else
/itl:PackageLatentImageRecord
  ↳/biom:FrictionRidgeImage
    ↳/biom:ImageCaptureDetail
      ↳/biom:ImageVerticalPixelDensityValue
endif
```

Summary

Integer pixel density in the vertical direction (if 13/SLC = 1 or 2); otherwise, if 13/SLC = 0, the vertical component of the pixel aspect ratio.

Technical Notes

If 13/SLC=1,2, then THPS shall equal TVPS.

Valid Examples

<code><biom:ImageVerticalPixelDensityValue>1000</biom:ImageVerticalPixelDensityValue></code>
--

12.14. Compression Algorithm - CGA

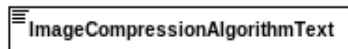

Field Reference: 13/CGA

Content Type: Data

XML Tag Name: ImageCompressionAlgorithmText

Data Type: AN

Minimum Length: 3

Minimum Occurrences: 1

Value range: *n/a*

Code table: see table A.6

Base type: nc:TextType

Field ID: [13.011]

Condition: Mandatory

Defined in: xsd/niem/biometrics/1.0/biometrics.xsd

Special Characters: *n/a*

Maximum Length: 5

Maximum Occurrences: 1

Regular Expression: *n/a*

Namespace: <http://niem.gov/niem/biometrics/1.0>

XPath

```

if [13/IMP] IN 4..7 then
/itl:PackageLatentImageRecord
  ↳/biom:FingerImpressionImage
  ↳/biom:ImageCompressionAlgorithmText
or
/itl:PackageLatentImageRecord
  ↳/biom:FrictionRidgeImage
  ↳/biom:ImageCompressionAlgorithmText
elseif [13/IMP] IN 12..15 then
/itl:PackageLatentImageRecord
  ↳/biom:PalmpointImage
  ↳/biom:ImageCompressionAlgorithmText
or
/itl:PackageLatentImageRecord
  ↳/biom:FrictionRidgeImage
  ↳/biom:ImageCompressionAlgorithmText
elseif [13/IMP] IN 28, 29 then
/itl:PackageLatentImageRecord
  ↳/biom:FingerImpressionImage
  ↳/biom:ImageCompressionAlgorithmText
or
/itl:PackageLatentImageRecord
  ↳/biom:PalmpointImage
  ↳/biom:ImageCompressionAlgorithmText
or
/itl:PackageLatentImageRecord
  ↳/biom:PlantarImage
  ↳/biom:ImageCompressionAlgorithmText
or
/itl:PackageLatentImageRecord
  ↳/biom:FrictionRidgeImage
  ↳/biom:ImageCompressionAlgorithmText
elseif [13/IMP] IN 32..35 then
/itl:PackageLatentImageRecord
  ↳/biom:PlantarImage
  ↳/biom:ImageCompressionAlgorithmText
or
/itl:PackageLatentImageRecord
  ↳/biom:FrictionRidgeImage
  ↳/biom:ImageCompressionAlgorithmText
else

```



```
/itl:PackageLatentImageRecord
  ↪/biom:FrictionRidgeImage
    ↪/biom:ImageCompressionAlgorithmText
endif
```

Summary

Algorithm used to compress the transmitted grayscale images.

Notes

Event if INTERPOL's implementation allows lossy compression algorithms for latents, it is recommended to use lossless algorithms.

Valid Examples

```
<biom:ImageCompressionAlgorithmText>NONE</biom:ImageCompressionAlgorithmText>
```

12.15. Bits Per Pixel - BPX

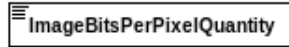

Field Reference: 13/BPX
Content Type: Data
XML Tag Name: ImageBitsPerPixelQuantity
Data Type: N
Minimum Length: 1
Minimum Occurrences: 1
Value range: {8}
Code table: *n/a*
Base type: niem-xsd:nonNegativeInteger

Field ID: [13.012]
Condition: Mandatory
Defined in: xsd/niem/biometrics/1.0/biometrics.xsd
Special Characters: *n/a*
Maximum Length: 2
Maximum Occurrences: 1
Regular Expression: *n/a*

Namespace: <http://niem.gov/niem/biometrics/1.0>

XPath

```

if [13/IMP] IN 4..7 then
/itl:PackageLatentImageRecord
  ↳/biom:FingerImpressionImage
or
  ↳/biom:ImageBitsPerPixelQuantity
or
/itl:PackageLatentImageRecord
  ↳/biom:FrictionRidgeImage
  ↳/biom:ImageBitsPerPixelQuantity
elseif [13/IMP] IN 12..15 then
/itl:PackageLatentImageRecord
  ↳/biom:PalmpointImage
  ↳/biom:ImageBitsPerPixelQuantity
or
/itl:PackageLatentImageRecord
  ↳/biom:FrictionRidgeImage
  ↳/biom:ImageBitsPerPixelQuantity
elseif [13/IMP] IN 28, 29 then
/itl:PackageLatentImageRecord
  ↳/biom:FingerImpressionImage
  ↳/biom:ImageBitsPerPixelQuantity
or
/itl:PackageLatentImageRecord
  ↳/biom:PalmpointImage
  ↳/biom:ImageBitsPerPixelQuantity
or
/itl:PackageLatentImageRecord
  ↳/biom:PlantarImage
  ↳/biom:ImageBitsPerPixelQuantity
or
/itl:PackageLatentImageRecord
  ↳/biom:FrictionRidgeImage
  ↳/biom:ImageBitsPerPixelQuantity
elseif [13/IMP] IN 32..35 then
/itl:PackageLatentImageRecord
  ↳/biom:PlantarImage
  ↳/biom:ImageBitsPerPixelQuantity
or
/itl:PackageLatentImageRecord
  ↳/biom:FrictionRidgeImage
  ↳/biom:ImageBitsPerPixelQuantity
else
/itl:PackageLatentImageRecord
  ↳/biom:FrictionRidgeImage
  ↳/biom:ImageBitsPerPixelQuantity
  
```

endif

Summary

Number of bits per pixel.

Notes

This field shall contain an entry of "8" for normal grayscale values of "0" to "255". Any entry in this field greater than "8" shall be used to represent a grayscale pixel with increased proportion. For color, BPX represents the total number of bits per pixel (not per color). For instance, BPX=24 represents a 24-bit RGB image using 8 bits for each color.

Valid Examples

<code><biom:ImageBitsPerPixelQuantity>8</biom:ImageBitsPerPixelQuantity></code>

12.16. Friction Ridge Generalized Position - FGP

Field Reference: 13/FGP	Field ID: [13.013]
Content Type: Data	Condition: Mandatory
XML Tag Name: PlantarPositionCode or FingerPositionCode or PalmPositionCode or FrictionRidgePositionCode	Defined in: xsd/niem/biometrics/1.0/biometrics.xsd
Data Type: N	Special Characters: <i>n/a</i>
Minimum Length: 1	Maximum Length: 2
Minimum Occurrences: 1	Maximum Occurrences: 6
Value range: {0..10,20..28}	Regular Expression: <i>n/a</i>
Code table: see table A.25 and table A.26	
Base type: biom:PlantarPositionCodeType or biom:PalmPositionCodeType or biom:FingerPositionCodeType or biom:FrictionRidgePositionCodeSimpleType	Namespace: http://niem.gov/niem/biometrics/1.0

XPath

```

if [13/IMP] IN 4..7 then
/itl:PackageLatentImageRecord
  ↘/biom:FingerImpressionImage
  ↘/biom:FingerPositionCode
or
/itl:PackageLatentImageRecord
  ↘/biom:FrictionRidgeImage
  ↘/biom:FrictionRidgePositionCode
elseif [13/IMP] IN 12..15 then
/itl:PackageLatentImageRecord
  ↘/biom:PalmpointImage
  ↘/biom:PalmPositionCode
or
/itl:PackageLatentImageRecord
  ↘/biom:FrictionRidgeImage
  ↘/biom:FrictionRidgePositionCode
elseif [13/IMP] IN 28..29 then
/itl:PackageLatentImageRecord
  ↘/biom:FingerImpressionImage
  ↘/biom:FingerPositionCode
or
/itl:PackageLatentImageRecord
  ↘/biom:PalmpointImage
  ↘/biom:PalmPositionCode
or
/itl:PackageLatentImageRecord
  ↘/biom:PlantarImage
  ↘/biom:PlantarPositionCode
or
/itl:PackageLatentImageRecord
  ↘/biom:FrictionRidgeImage
  ↘/biom:FrictionRidgePositionCode
elseif [13/IMP] IN 32..35 then
/itl:PackageLatentImageRecord
  ↘/biom:PlantarImage
  ↘/biom:PlantarPositionCode
or
/itl:PackageLatentImageRecord
  ↘/biom:FrictionRidgeImage
  ↘/biom:FrictionRidgePositionCode
else
/itl:PackageLatentImageRecord
  ↘/biom:FrictionRidgeImage
  ↘/biom:FrictionRidgePositionCode
endif

```

12. Friction-ridge Latent Image Record (aka Type 13)

Summary

The finger, palm or plantar position that matches the latent image.

Valid Examples

```
<biom:PlantarPositionCode>2</biom:PlantarPositionCode>
```

12.17. Scanned Horizontal Pixel Scale - SHPS

CaptureHorizontalPixelDensityValue

Field Reference: 13/SHPS

Content Type: Data

XML Tag Name: CaptureHorizontalPixelDensityValue

Data Type: N

Minimum Length: 1

Minimum Occurrences: 0

Value range: *n/a*

Code table: *n/a*

Base type: niem-xsd:nonNegativeInteger

Field ID: [13.016]

Condition: Optional

Defined in: xsd/niem/biometrics/1.0/biometrics.xsd

Special Characters: *n/a*

Maximum Length: 5

Maximum Occurrences: 1

Regular Expression: *n/a*

Namespace: <http://niem.gov/niem/biometrics/1.0>

XPath

```

if [13/IMP] IN 4..7 then
/itl:PackageLatentImageRecord
  ↳/biom:FingerImpressionImage
    ↳/biom:ImageCaptureDetail
      ↳/biom:CaptureHorizontalPixelDensityValue
or
/itl:PackageLatentImageRecord
  ↳/biom:FrictionRidgeImage
    ↳/biom:ImageCaptureDetail
      ↳/biom:CaptureHorizontalPixelDensityValue
elseif [13/IMP] IN 12..15 then
/itl:PackageLatentImageRecord
  ↳/biom:PalmpointImage
    ↳/biom:ImageCaptureDetail
      ↳/biom:CaptureHorizontalPixelDensityValue
or
/itl:PackageLatentImageRecord
  ↳/biom:FrictionRidgeImage
    ↳/biom:ImageCaptureDetail
      ↳/biom:CaptureHorizontalPixelDensityValue
elseif [13/IMP] IN 28, 29 then
/itl:PackageLatentImageRecord
  ↳/biom:FingerImpressionImage
    ↳/biom:ImageCaptureDetail
      ↳/biom:CaptureHorizontalPixelDensityValue
or
/itl:PackageLatentImageRecord
  ↳/biom:PalmpointImage
    ↳/biom:ImageCaptureDetail
      ↳/biom:CaptureHorizontalPixelDensityValue
or
/itl:PackageLatentImageRecord
  ↳/biom:PlantarImage
    ↳/biom:ImageCaptureDetail
      ↳/biom:CaptureHorizontalPixelDensityValue
or
/itl:PackageLatentImageRecord
  ↳/biom:FrictionRidgeImage
    ↳/biom:ImageCaptureDetail
      ↳/biom:CaptureHorizontalPixelDensityValue
elseif [13/IMP] IN 32..35 then

```

```
/itl:PackageLatentImageRecord
  ↳/biom:PlantarImage
    ↳/biom:ImageCaptureDetail
      ↳/biom:CaptureHorizontalPixelDensityValue
or
/itl:PackageLatentImageRecord
  ↳/biom:FrictionRidgeImage
    ↳/biom:ImageCaptureDetail
      ↳/biom:CaptureHorizontalPixelDensityValue
else
/itl:PackageLatentImageRecord
  ↳/biom:FrictionRidgeImage
    ↳/biom:ImageCaptureDetail
      ↳/biom:CaptureHorizontalPixelDensityValue
endif
```

Summary

Horizontal pixel density used for scanning the original image/impression or horizontal component of pixel aspect ratio. This field is used if the transmission pixel scale differs from the original image scale.

Technical Notes

If 13/SLC=1,2, then SHPS shall equal SVPS.

Valid Examples

<code><biom:CaptureHorizontalPixelDensityValue>500</biom:CaptureHorizontalPixelDensityValue></code>

12.18. Scanned Vertical Pixel Scale - SVPS



Field Reference: 13/SVPS	Field ID: [13.017]
Content Type: Data	Condition: Optional
XML Tag Name: CaptureVerticalPixelDensityValue	Defined in: xsd/niem/biometrics/1.0/biometrics.xsd
Data Type: N	Special Characters: <i>n/a</i>
Minimum Length: 1	Maximum Length: 5
Minimum Occurrences: 0	Maximum Occurrences: 1
Value range: <i>n/a</i>	Regular Expression: <i>n/a</i>
Code table: <i>n/a</i>	
Base type: niem-xsd:nonNegativeInteger	Namespace: http://niem.gov/niem/biometrics/1.0

XPath

```

if [13/IMP] IN 4..7 then
/itl:PackageLatentImageRecord
  ↳/biom:FingerImpressionImage
    ↳/biom:ImageCaptureDetail
      ↳/biom:CaptureVerticalPixelDensityValue
or
/itl:PackageLatentImageRecord
  ↳/biom:FrictionRidgeImage
    ↳/biom:ImageCaptureDetail
      ↳/biom:CaptureVerticalPixelDensityValue
elseif [13/IMP] IN 12..15 then
/itl:PackageLatentImageRecord
  ↳/biom:PalmpointImage
    ↳/biom:ImageCaptureDetail
      ↳/biom:CaptureVerticalPixelDensityValue
or
/itl:PackageLatentImageRecord
  ↳/biom:FrictionRidgeImage
    ↳/biom:ImageCaptureDetail
      ↳/biom:CaptureVerticalPixelDensityValue
elseif [13/IMP] IN 28, 29 then
/itl:PackageLatentImageRecord
  ↳/biom:FingerImpressionImage
    ↳/biom:ImageCaptureDetail
      ↳/biom:CaptureVerticalPixelDensityValue
or
/itl:PackageLatentImageRecord
  ↳/biom:PalmpointImage
    ↳/biom:ImageCaptureDetail
      ↳/biom:CaptureVerticalPixelDensityValue
or
/itl:PackageLatentImageRecord
  ↳/biom:PlantarImage
    ↳/biom:ImageCaptureDetail
      ↳/biom:CaptureVerticalPixelDensityValue
or
/itl:PackageLatentImageRecord
  ↳/biom:FrictionRidgeImage
    ↳/biom:ImageCaptureDetail
      ↳/biom:CaptureVerticalPixelDensityValue
elseif [13/IMP] IN 32..35 then

```



```
/itl:PackageLatentImageRecord
  ↪/biom:PlantarImage
    ↪/biom:ImageCaptureDetail
      ↪/biom:CaptureVerticalPixelDensityValue
or
/itl:PackageLatentImageRecord
  ↪/biom:FrictionRidgeImage
    ↪/biom:ImageCaptureDetail
      ↪/biom:CaptureVerticalPixelDensityValue
else
/itl:PackageLatentImageRecord
  ↪/biom:FrictionRidgeImage
    ↪/biom:ImageCaptureDetail
      ↪/biom:CaptureVerticalPixelDensityValue
endif
```

Summary

Vertical pixel density used for scanning the original image/impression or vertical component of pixel aspect ratio. This field is used if the transmission pixel scale differs from the original image scale.

Technical Notes

If 13/SLC=1,2, then SHPS shall equal SVPS.

Valid Examples

<code><biom:CaptureVerticalPixelDensityValue>500</biom:CaptureVerticalPixelDensityValue></code>

12.19. Comment - COM

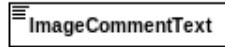

Field Reference: 13/COM	Field ID: [13.020]
Content Type: Data	Condition: Optional
XML Tag Name: ImageCommentText	Defined in: xsd/niem/biometrics/1.0/biometrics.xsd
Data Type: U	Special Characters: <i>n/a</i>
Minimum Length: 1	Maximum Length: 126
Minimum Occurrences: 0	Maximum Occurrences: 1
Value range: <i>n/a</i>	Regular Expression: <i>n/a</i>
Code table: <i>n/a</i>	
Base type: nc:TextType	Namespace: http://niem.gov/niem/biometrics/1.0

XPath

```

if [13/IMP] IN 4..7 then
/itl:PackageLatentImageRecord
  ↳/biom:FingerImpressionImage
  ↳/biom:ImageCommentText
or
/itl:PackageLatentImageRecord
  ↳/biom:FrictionRidgeImage
  ↳/biom:ImageCommentText
elseif [13/IMP] IN 12..15 then
/itl:PackageLatentImageRecord
  ↳/biom:PalmpointImage
  ↳/biom:ImageCommentText
or
/itl:PackageLatentImageRecord
  ↳/biom:FrictionRidgeImage
  ↳/biom:ImageCommentText
elseif [13/IMP] IN 28, 29 then
/itl:PackageLatentImageRecord
  ↳/biom:FingerImpressionImage
  ↳/biom:ImageCommentText
or
/itl:PackageLatentImageRecord
  ↳/biom:PalmpointImage
  ↳/biom:ImageCommentText
or
/itl:PackageLatentImageRecord
  ↳/biom:PlantarImage
  ↳/biom:ImageCommentText
or
/itl:PackageLatentImageRecord
  ↳/biom:FrictionRidgeImage
  ↳/biom:ImageCommentText
elseif [13/IMP] IN 32..35 then
/itl:PackageLatentImageRecord
  ↳/biom:PlantarImage
  ↳/biom:ImageCommentText
or
/itl:PackageLatentImageRecord
  ↳/biom:FrictionRidgeImage
  ↳/biom:ImageCommentText
else
/itl:PackageLatentImageRecord
  ↳/biom:FrictionRidgeImage
  ↳/biom:ImageCommentText

```

12. Friction-ridge Latent Image Record (aka Type 13)

endif

Summary

Free text information. It is not reserved exclusively for log-related information but has historically often been used for this purpose.

Valid Examples

```
<biom:ImageCommentText>Comment</biom:ImageCommentText>
```

12.20. Latent Quality Metric - LQM

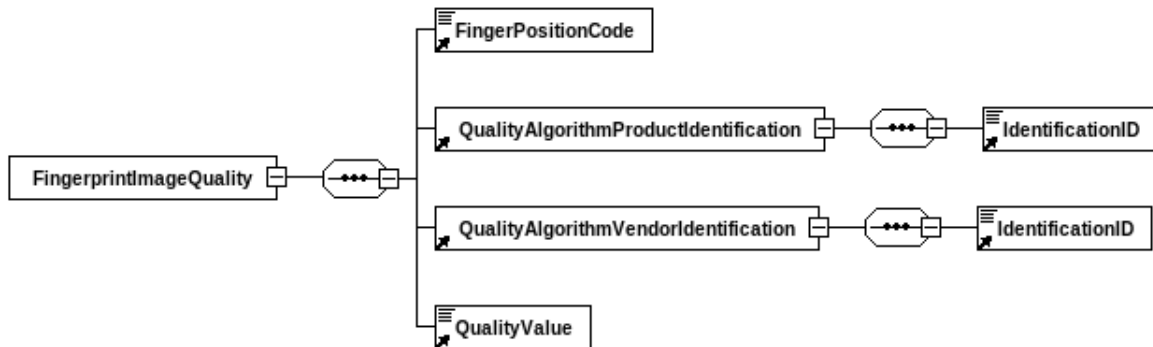

Field Reference: 13/LQM

Content Type: Set

XML Tag Name: FingerprintImageQuality or PalmprintImageQuality or PlantarImageQuality or FrictionRidgeImageQuality

Data Type:

Minimum Length:

Minimum Occurrences: 0

Value range: *n/a*

Code table: *n/a*

Base type: biom:FingerprintImageQualityType
 or biom:PlantarImageQualityType
 or biom:PalmprintImageQualityType
 or biom:FrictionRidgeImageQualityType

Field ID: [13.024]

Condition: Optional

Defined in: xsd/niem/biometrics/1.0/biometrics.xsd

Special Characters: *n/a*

Maximum Length:

Maximum Occurrences: 9

Regular Expression: *n/a*

Namespace: <http://niem.gov/niem/biometrics/1.0>

XPath

```

if [13/IMP] IN 4..7 then
/itl:PackageLatentImageRecord
  ↘/biom:FingerImpressionImage
  ↘/biom:FingerprintImageQuality
or
/itl:PackageLatentImageRecord
  ↘/biom:FrictionRidgeImage
  ↘/biom:FrictionRidgeImageQuality
elseif [13/IMP] IN 12..15 then
/itl:PackageLatentImageRecord
  ↘/biom:PalmpointImage
  ↘/biom:PalmpointImageQuality
or
/itl:PackageLatentImageRecord
  ↘/biom:FrictionRidgeImage
  ↘/biom:FrictionRidgeImageQuality
elseif [13/IMP] IN 28, 29 then
/itl:PackageLatentImageRecord
  ↘/biom:FingerImpressionImage
  ↘/biom:FingerprintImageQuality
or
/itl:PackageLatentImageRecord
  ↘/biom:PalmpointImage
  ↘/biom:PalmpointImageQuality
or

```

```
/itl:PackageLatentImageRecord
  ↳/biom:PlantarImage
or
  ↳/biom:PlantarImageQuality
or
/itl:PackageLatentImageRecord
  ↳/biom:FrictionRidgeImage
  ↳/biom:FrictionRidgeImageQuality
elseif [13/IMP] IN 32..35 then
/itl:PackageLatentImageRecord
  ↳/biom:PlantarImage
  ↳/biom:PlantarImageQuality
or
/itl:PackageLatentImageRecord
  ↳/biom:FrictionRidgeImage
  ↳/biom:FrictionRidgeImageQuality
else
/itl:PackageLatentImageRecord
  ↳/biom:FrictionRidgeImage
  ↳/biom:FrictionRidgeImageQuality
endif
```

Summary

Specifies one or more different metrics of latent image quality score data for the image stored in this record.

12.21. Friction Ridge Metric Position - FRMP

Field Reference: 13/LQM/FRMP

Content Type: Data

XML Tag Name: PlantarPositionCode or FingerPositionCode or PalmPositionCode or FrictionRidgePositionCode

Data Type: N

Minimum Length: 1

Minimum Occurrences: 1

Value range: *n/a*

Code table: see table A.25 and table A.26

Base type: biom:PlantarPositionCodeType or biom:PalmPositionCodeType or biom:FingerPositionCodeType or biom:FrictionRidgePositionCodeSimpleType

Field ID: [13.024-A]

Condition: Mandatory within a field

Defined in: xsd/niem/biometrics/1.0/biometrics.xsd

Special Characters: *n/a*

Maximum Length: 2

Maximum Occurrences: 1

Regular Expression: *n/a*

Namespace: <http://niem.gov/niem/biometrics/1.0>

XPath

```

if [13/IMP] IN 4..7 then
/itl:PackageLatentImageRecord
  ↪/biom:FingerImpressionImage
    ↪/biom:FingerprintImageQuality
      ↪/biom:FingerPositionCode
or
/itl:PackageLatentImageRecord
  ↪/biom:FrictionRidgeImage
    ↪/biom:FrictionRidgeImageQuality
      ↪/biom:FrictionRidgePositionCode
elseif [13/IMP] IN 12..15 then
/itl:PackageLatentImageRecord
  ↪/biom:PalmpointImage
    ↪/biom:PalmpointImageQuality
      ↪/biom:PalmPositionCode
or
/itl:PackageLatentImageRecord
  ↪/biom:FrictionRidgeImage
    ↪/biom:FrictionRidgeImageQuality
      ↪/biom:FrictionRidgePositionCode
elseif [13/IMP] IN 28, 29 then
/itl:PackageLatentImageRecord
  ↪/biom:FingerImpressionImage
    ↪/biom:FingerprintImageQuality
      ↪/biom:FingerPositionCode
or
/itl:PackageLatentImageRecord
  ↪/biom:PalmpointImage
    ↪/biom:PalmpointImageQuality
      ↪/biom:PalmPositionCode
or
/itl:PackageLatentImageRecord
  ↪/biom:PlantarImage
    ↪/biom:PlantarImageQuality
      ↪/biom:PlantarPositionCode
or
/itl:PackageLatentImageRecord
  ↪/biom:FrictionRidgeImage
    ↪/biom:FrictionRidgeImageQuality
      ↪/biom:FrictionRidgePositionCode
elseif [13/IMP] IN 32..35 then
/itl:PackageLatentImageRecord
  ↪/biom:PlantarImage
    ↪/biom:PlantarImageQuality
      ↪/biom:PlantarPositionCode

```

12. Friction-ridge Latent Image Record (aka Type 13)

```
or
/itl:PackageLatentImageRecord
  ↙/biom:FrictionRidgeImage
    ↙/biom:FrictionRidgeImageQuality
      ↙/biom:FrictionRidgePositionCode
else
/itl:PackageLatentImageRecord
  ↙/biom:FrictionRidgeImage
    ↙/biom:FrictionRidgeImageQuality
      ↙/biom:FrictionRidgePositionCode
endif
```

Summary

Finger, palm or plantar position.

Valid Examples

```
<biom:PlantarPositionCode>2</biom:PlantarPositionCode>
```

12.22. Quality Value - QVU

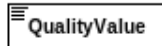

Field Reference: 13/LQM/QVU
Content Type: Data
XML Tag Name: QualityValue
Data Type: N
Minimum Length: 1
Minimum Occurrences: 1
Value range: {0..100,254,255}
Code table: see table A.48 *
Base type: niem-xsd:integer

Field ID: [13.024-B]
Condition: Mandatory within a field
Defined in: xsd/niem/biometrics/1.0/biometrics.xsd
Special Characters: *n/a*
Maximum Length: 3
Maximum Occurrences: 1
Regular Expression: *n/a*
Namespace: <http://niem.gov/niem/biometrics/1.0>

XPath

```

if [13/IMP] IN 4..7 then
/itl:PackageLatentImageRecord
  ↳/biom:FingerImpressionImage
    ↳/biom:FingerprintImageQuality
      ↳/biom:QualityValue
or
/itl:PackageLatentImageRecord
  ↳/biom:FrictionRidgeImage
    ↳/biom:FrictionRidgeImageQuality
      ↳/biom:QualityValue
elseif [13/IMP] IN 12..15 then
/itl:PackageLatentImageRecord
  ↳/biom:PalmpointImage
    ↳/biom:PalmpointImageQuality
      ↳/biom:QualityValue
or
/itl:PackageLatentImageRecord
  ↳/biom:FrictionRidgeImage
    ↳/biom:FrictionRidgeImageQuality
      ↳/biom:QualityValue
elseif [13/IMP] IN 28, 29 then
/itl:PackageLatentImageRecord
  ↳/biom:FingerImpressionImage
    ↳/biom:FingerprintImageQuality
      ↳/biom:QualityValue
or
/itl:PackageLatentImageRecord
  ↳/biom:PalmpointImage
    ↳/biom:PalmpointImageQuality
      ↳/biom:QualityValue
or
/itl:PackageLatentImageRecord
  ↳/biom:PlantarImage
    ↳/biom:PlantarImageQuality
      ↳/biom:QualityValue
or
/itl:PackageLatentImageRecord
  ↳/biom:FrictionRidgeImage
    ↳/biom:FrictionRidgeImageQuality
      ↳/biom:QualityValue
elseif [13/IMP] IN 32..35 then
  
```



```
/itl:PackageLatentImageRecord
  ↪/biom:PlantarImage
    ↪/biom:PlantarImageQuality
      ↪/biom:QualityValue
or
/itl:PackageLatentImageRecord
  ↪/biom:FrictionRidgeImage
    ↪/biom:FrictionRidgeImageQuality
      ↪/biom:QualityValue
else
/itl:PackageLatentImageRecord
  ↪/biom:FrictionRidgeImage
    ↪/biom:FrictionRidgeImageQuality
      ↪/biom:QualityValue
endif
```

Summary

Quantitative expression of predicted matching performance of biometric sample. This information item shall contain the integer image quality score assigned to the image data by a quality algorithm. Higher values indicate better quality.

Valid Examples

<code><biom:QualityValue>100</biom:QualityValue></code>

*The code table is optional, defining commonly-used or special-purpose values, rather than definitive (listing all possible values).

12.23. Algorithm Vendor ID - QAV

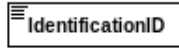

Field Reference: 13/LQM/QAV

Content Type: Data

XML Tag Name: IdentificationID

Data Type: H

Minimum Length: 4

Minimum Occurrences: 1

Value range: *n/a*

Code table: *n/a*

Base type: niem-xsd:string

Field ID: [13.024-C]

Condition: Mandatory within a field

Defined in: xsd/niem/niem-core/2.0/niem-core.xsd

Special Characters: *n/a*

Maximum Length: 4

Maximum Occurrences: 1

Regular Expression: *n/a*

Namespace: <http://niem.gov/niem/niem-core/2.0>

XPath

```

if [13/IMP] IN 4..7 then
/itl:PackageLatentImageRecord
  ↳/biom:FingerImpressionImage
    ↳/biom:FingerprintImageQuality
      ↳/biom:QualityAlgorithmVendorIdentification
        ↳/nc:IdentificationID
or
/itl:PackageLatentImageRecord
  ↳/biom:FrictionRidgeImage
    ↳/biom:FrictionRidgeImageQuality
      ↳/biom:QualityAlgorithmVendorIdentification
        ↳/nc:IdentificationID
elseif [13/IMP] IN 12..15 then
/itl:PackageLatentImageRecord
  ↳/biom:PalmpointImage
    ↳/biom:PalmpointImageQuality
      ↳/biom:QualityAlgorithmVendorIdentification
        ↳/nc:IdentificationID
or
/itl:PackageLatentImageRecord
  ↳/biom:FrictionRidgeImage
    ↳/biom:FrictionRidgeImageQuality
      ↳/biom:QualityAlgorithmVendorIdentification
        ↳/nc:IdentificationID
elseif [13/IMP] IN 28, 29 then
/itl:PackageLatentImageRecord
  ↳/biom:FingerImpressionImage
    ↳/biom:FingerprintImageQuality
      ↳/biom:QualityAlgorithmVendorIdentification
        ↳/nc:IdentificationID
or
/itl:PackageLatentImageRecord
  ↳/biom:PalmpointImage
    ↳/biom:PalmpointImageQuality
      ↳/biom:QualityAlgorithmVendorIdentification
        ↳/nc:IdentificationID
or
/itl:PackageLatentImageRecord
  ↳/biom:PlantarImage
    ↳/biom:PlantarImageQuality
      ↳/biom:QualityAlgorithmVendorIdentification
        ↳/nc:IdentificationID

```

```
or
/itl:PackageLatentImageRecord
  ↪/biom:FrictionRidgeImage
    ↪/biom:FrictionRidgeImageQuality
      ↪/biom:QualityAlgorithmVendorIdentification
        ↪/nc:IdentificationID
elseif [13/IMP] IN 32..35 then
/itl:PackageLatentImageRecord
  ↪/biom:PlantarImage
    ↪/biom:PlantarImageQuality
      ↪/biom:QualityAlgorithmVendorIdentification
        ↪/nc:IdentificationID
or
/itl:PackageLatentImageRecord
  ↪/biom:FrictionRidgeImage
    ↪/biom:FrictionRidgeImageQuality
      ↪/biom:QualityAlgorithmVendorIdentification
        ↪/nc:IdentificationID
else
/itl:PackageLatentImageRecord
  ↪/biom:FrictionRidgeImage
    ↪/biom:FrictionRidgeImageQuality
      ↪/biom:QualityAlgorithmVendorIdentification
        ↪/nc:IdentificationID
endif
```

Summary

ID of the vendor of the quality algorithm used to calculate the quality score. This value is assigned by IBIA, which maintains the Vendor Registry of CBEFF Biometric Organizations that map the value in this field to a registered organization.

Valid Examples

```
<nc:IdentificationID>FFF0</nc:IdentificationID>
```

12.24. Algorithm Product Identification - QAP

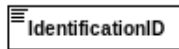

Field Reference: 13/LQM/QAP

Content Type: Data

XML Tag Name: IdentificationID

Data Type: N

Minimum Length: 1

Minimum Occurrences: 1

Value range: {1..65535}

Code table: *n/a*

Base type: niem-xsd:string

Field ID: [13.024-D]

Condition: Mandatory within a field

Defined in: xsd/niem/niem-core/2.0/niem-core.xsd

Special Characters: *n/a*

Maximum Length: 5

Maximum Occurrences: 1

Regular Expression: *n/a*

Namespace: <http://niem.gov/niem/niem-core/2.0>

XPath

```

if [13/IMP] IN 4..7 then
/itl:PackageLatentImageRecord
  ↳/biom:FingerImpressionImage
    ↳/biom:FingerprintImageQuality
      ↳/biom:QualityAlgorithmProductIdentification
        ↳/nc:IdentificationID
or
/itl:PackageLatentImageRecord
  ↳/biom:FrictionRidgeImage
    ↳/biom:FrictionRidgeImageQuality
      ↳/biom:QualityAlgorithmProductIdentification
        ↳/nc:IdentificationID
elseif [13/IMP] IN 12..15 then
/itl:PackageLatentImageRecord
  ↳/biom:PalmpointImage
    ↳/biom:PalmpointImageQuality
      ↳/biom:QualityAlgorithmProductIdentification
        ↳/nc:IdentificationID
or
/itl:PackageLatentImageRecord
  ↳/biom:FrictionRidgeImage
    ↳/biom:FrictionRidgeImageQuality
      ↳/biom:QualityAlgorithmProductIdentification
        ↳/nc:IdentificationID
elseif [13/IMP] IN 28, 29 then
/itl:PackageLatentImageRecord
  ↳/biom:FingerImpressionImage
    ↳/biom:FingerprintImageQuality
      ↳/biom:QualityAlgorithmProductIdentification
        ↳/nc:IdentificationID
or
/itl:PackageLatentImageRecord
  ↳/biom:PalmpointImage
    ↳/biom:PalmpointImageQuality
      ↳/biom:QualityAlgorithmProductIdentification
        ↳/nc:IdentificationID
or
/itl:PackageLatentImageRecord
  ↳/biom:PlantarImage
    ↳/biom:PlantarImageQuality
      ↳/biom:QualityAlgorithmProductIdentification
        ↳/nc:IdentificationID

```

```

or
/itl:PackageLatentImageRecord
  ↪/biom:FrictionRidgeImage
    ↪/biom:FrictionRidgeImageQuality
      ↪/biom:QualityAlgorithmProductIdentification
        ↪/nc:IdentificationID
elseif [13/IMP] IN 32..35 then
/itl:PackageLatentImageRecord
  ↪/biom:PlantarImage
    ↪/biom:PlantarImageQuality
      ↪/biom:QualityAlgorithmProductIdentification
        ↪/nc:IdentificationID
or
/itl:PackageLatentImageRecord
  ↪/biom:FrictionRidgeImage
    ↪/biom:FrictionRidgeImageQuality
      ↪/biom:QualityAlgorithmProductIdentification
        ↪/nc:IdentificationID
else
/itl:PackageLatentImageRecord
  ↪/biom:FrictionRidgeImage
    ↪/biom:FrictionRidgeImageQuality
      ↪/biom:QualityAlgorithmProductIdentification
        ↪/nc:IdentificationID
endif

```

Summary

Numeric product code assigned by the vendor of the quality algorithm (may be registered with the IBIA, but registration is not required).

Valid Examples

<nc:IdentificationID>28495</nc:IdentificationID>

12.25. Friction Ridge Capture Technology - FCT

 FrictionRidgeCaptureTechnology

Field Reference: 13/FCT	Field ID: [13.901]
Content Type: Data_X	Condition: Optional
XML Tag Name: FrictionRidgeCaptureTechnology	Defined in: xsd/niem/biometrics/1.0/biometrics.xsd
Data Type: N	Special Characters: <i>n/a</i>
Minimum Length: 1	Maximum Length: 2
Minimum Occurrences: 0	Maximum Occurrences: 1
Value range: {0,18..22}	Regular Expression: <i>n/a</i>
Code table: see table A.24	
Base type: biom:FrictionRidgeCaptureTechnologyType	Namespace: http://niem.gov/niem/biometrics/1.0

XPath

```

if [13/IMP] IN 4..7 then
/itl:PackageLatentImageRecord
  ↳/biom:FingerImpressionImage
    ↳/biom:FrictionRidgeCaptureTechnology
or
/itl:PackageLatentImageRecord
  ↳/biom:FrictionRidgeImage
    ↳/biom:FrictionRidgeCaptureTechnology
elseif [13/IMP] IN 12..15 then
/itl:PackageLatentImageRecord
  ↳/biom:PalmprintImage
    ↳/biom:FrictionRidgeCaptureTechnology
or
/itl:PackageLatentImageRecord
  ↳/biom:FrictionRidgeImage
    ↳/biom:FrictionRidgeCaptureTechnology
elseif [13/IMP] IN 28, 29 then
/itl:PackageLatentImageRecord
  ↳/biom:FingerImpressionImage
    ↳/biom:FrictionRidgeCaptureTechnology
or
/itl:PackageLatentImageRecord
  ↳/biom:PalmprintImage
    ↳/biom:FrictionRidgeCaptureTechnology
or
/itl:PackageLatentImageRecord
  ↳/biom:PlantarImage
    ↳/biom:FrictionRidgeCaptureTechnology
elseif [13/IMP] IN 32..35 then
/itl:PackageLatentImageRecord
  ↳/biom:PlantarImage
    ↳/biom:FrictionRidgeCaptureTechnology
or
/itl:PackageLatentImageRecord
  ↳/biom:FrictionRidgeImage
    ↳/biom:FrictionRidgeCaptureTechnology
else

```

12. Friction-ridge Latent Image Record (aka Type 13)

```
/itl:PackageLatentImageRecord
  ↪/biom:FrictionRidgeImage
    ↪/biom:FrictionRidgeCaptureTechnology
endif
```

Summary

The technology used to capture friction ridge data

Valid Examples

```
<biom:FrictionRidgeCaptureTechnology>0</biom:FrictionRidgeCaptureTechnology>
```

12.26. Latent Friction Ridge Image - DATA

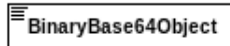

Field Reference: 13/DATA

Content Type: Data

XML Tag Name: BinaryBase64Object

Data Type: B

Minimum Length: 1

Minimum Occurrences: 1

Value range: *n/a*

Code table: *n/a*

Base type: niem-xsd:base64Binary

Field ID: [13.999]

Condition: Mandatory

Defined in: xsd/niem/niem-core/2.0/niem-core.xsd

Special Characters: *n/a*

Maximum Length: *

Maximum Occurrences: 1

Regular Expression: *n/a*

Namespace: <http://niem.gov/niem/niem-core/2.0>

XPath

```

if [13/IMP] IN 4..7 then
/itl:PackageLatentImageRecord
  ↳/biom:FingerImpressionImage
    ↳/nc:BinaryBase64Object
or
/itl:PackageLatentImageRecord
  ↳/biom:FrictionRidgeImage
    ↳/nc:BinaryBase64Object
elseif [13/IMP] IN 12..15 then
/itl:PackageLatentImageRecord
  ↳/biom:PalmpointImage
    ↳/nc:BinaryBase64Object
or
/itl:PackageLatentImageRecord
  ↳/biom:FrictionRidgeImage
    ↳/nc:BinaryBase64Object
elseif [13/IMP] IN 28, 29 then
/itl:PackageLatentImageRecord
  ↳/biom:FingerImpressionImage
    ↳/nc:BinaryBase64Object
or
/itl:PackageLatentImageRecord
  ↳/biom:PalmpointImage
    ↳/nc:BinaryBase64Object
or
/itl:PackageLatentImageRecord
  ↳/biom:PlantarImage
    ↳/nc:BinaryBase64Object
or
/itl:PackageLatentImageRecord
  ↳/biom:FrictionRidgeImage
    ↳/nc:BinaryBase64Object
elseif [13/IMP] IN 32..35 then
/itl:PackageLatentImageRecord
  ↳/biom:PlantarImage
    ↳/nc:BinaryBase64Object
or
/itl:PackageLatentImageRecord
  ↳/biom:FrictionRidgeImage
    ↳/nc:BinaryBase64Object
else

```

12. Friction-ridge Latent Image Record (aka Type 13)

```
/itl:PackageLatentImageRecord
  ↪/biom:FrictionRidgeImage
    ↪/nc:BinaryBase64Object
endif
```

Summary

Contains the latent image.

Notes

Binary for Traditional encoding or Base64 for XML

Valid Examples

```
<nc:BinaryBase64Object>mrHbPdrko3uis7ahtgPBjtm01s85tfG2U7bpofY94Czu2SbY7d7wF9fQ7ZptgGrtk02a2dsJ7wZbe8BlzvAmQ7xq+
Y94GoHeEsR3ikWd4DIGhmp3k42d4DRmzs94DKveDTB3hqw6PeBLrtpPep0H/+h</nc:BinaryBase64Object>
```

12.27. Field Mandatoriness in Friction-ridge Latent Image Record

The following table shows a summary of the fields and information items in each record type and its corresponding XML elements, and in particular the fields and items that are mandatory.

Table 12.1.: Field Summary for Type 13 Records

Field Id	Code	Field Name	Card.	Notes
13/XRCC:X	[13.001:X]	XML Record Category Code	M	
13/IDC	[13.002]	Information Designation Character	M	
13/IMP_13/DATA	[13.003_13.999]	Image Type (XML)	M	
13/IMP	[13.003]	Impression Type	M	
13/SRC_13/SAN	[13.004_13.993]	Capture Organization (XML)	M	
13/SRC	[13.004]	Source Agency	M	
13/LCD:X	[13.005:X]	Latent Capture Date (XML)	M	
13/HLL	[13.006]	Horizontal Line Length	M	
13/VLL	[13.007]	Vertical Line Length	M	
13/SLC	[13.008]	Scale Units	M	
13/THPS	[13.009]	Transmitted Horizontal Pixel Scale	M	
13/TVPS	[13.010]	Transmitted Vertical Pixel Scale	M	
13/CGA	[13.011]	Compression Algorithm	M	
13/BPX	[13.012]	Bits Per Pixel	M	
13/FGP	[13.013]	Friction Ridge Generalized Position	M	
13/SHPS	[13.016]	Scanned Horizontal Pixel Scale	O	
13/SVPS	[13.017]	Scanned Vertical Pixel Scale	O	
13/COM	[13.020]	Comment	O	
13/LQM	[13.024]	Latent Quality Metric	O	
13/LQM/FRMP	[13.024-A]	Friction Ridge Metric Position	M^	
13/LQM/QVU	[13.024-B]	Quality Value	M^	
13/LQM/QAV	[13.024-C]	Algorithm Vendor ID	M^	
13/LQM/QAP	[13.024-D]	Algorithm Product Identification	M^	
13/FCT	[13.901]	Friction Ridge Capture Technology	O	
13/DATA	[13.999]	Latent Friction Ridge Image	M	

M=Mandatory, O=Optional, M^=Mandatory Info Item within a Field, O^=Optional Info Item within a Field, D=Dependent on other Fields/Info Items

13. Fingerprint Image Record (aka Type 14)

This chapter describes all the fields that are used in the Fingerprint Image Record.

13.1. Package Fingerprint Image Record (XML)

Field Reference: 14	Field ID: [14]
Content Type: Set_X	Condition: Optional
XML Tag Name: PackageFingerprintImageRecord	Defined in: xsd/itl/2011/ITL-2007f-Package.xsd
Data Type:	Special Characters: <i>n/a</i>
Minimum Length:	Maximum Length:
Minimum Occurrences: 0	Maximum Occurrences: *
Value range: <i>n/a</i>	Regular Expression: <i>n/a</i>
Code table: <i>n/a</i>	
Base type: itl:PackageFingerImpressionImageRecordType	Namespace: http://biometrics.nist.gov/standard/2011

XPath

/itl:PackageFingerprintImageRecord

Summary

Contains and is used to exchange exemplar fingerprint image data, such as a rolled tenprint, an identification flat, or a complete friction ridge exemplar.

13. Fingerprint Image Record (aka Type 14)

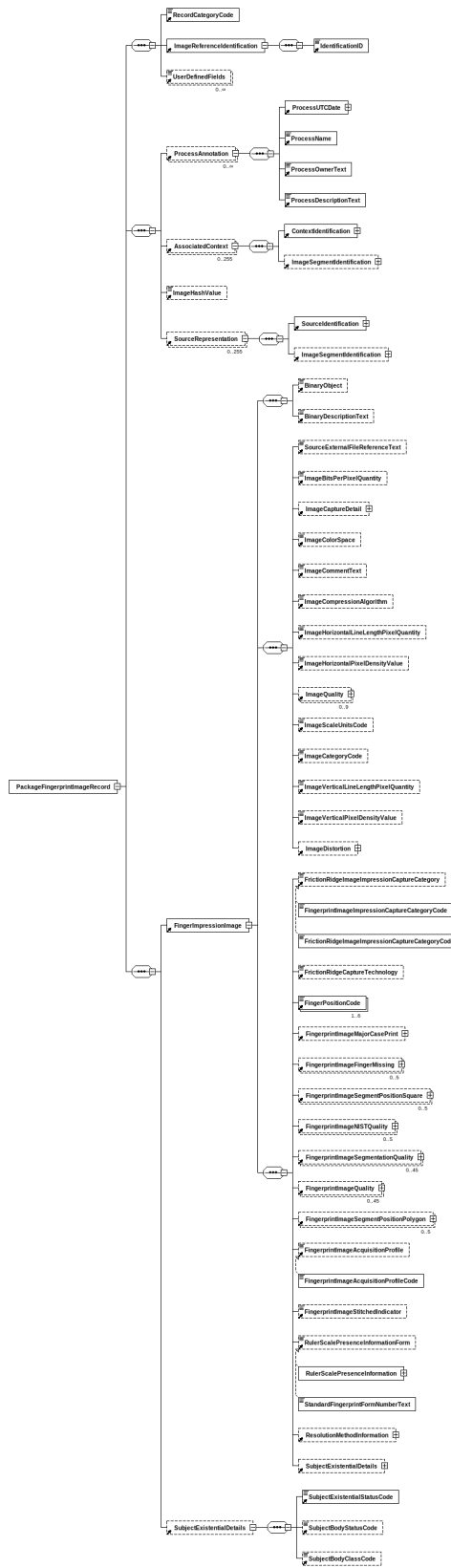

13.2. XML Record Category Code - XRCC

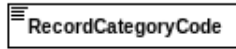

Field Reference: 14/XRCC:X

Content Type: Data_X

XML Tag Name: RecordCategoryCode

Data Type: N

Minimum Length: 1

Minimum Occurrences: 1

Value range: {14}

Code table: *n/a*

Base type: biom:RecordCategoryCodeType

Field ID: [14.001:X]

Condition: Mandatory

Defined in: xsd/niem/biometrics/1.0/biometrics.xsd

Special Characters: *n/a*

Maximum Length: 2

Maximum Occurrences: 1

Regular Expression: *n/a*

Namespace: <http://niem.gov/niem/biometrics/1.0>

XPath

```
/it1:PackageFingerprintImageRecord  
  ↘/biom:RecordCategoryCode
```

Summary

Numeric representation of Record Type.

Valid Examples

```
<biom:RecordCategoryCode>14</biom:RecordCategoryCode>
```

13.3. Information Designation Character - IDC

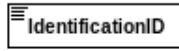

Field Reference: 14/IDC

Content Type: Data

XML Tag Name: IdentificationID

Data Type: N

Minimum Length: 1

Minimum Occurrences: 1

Value range: {0..99}

Code table: *n/a*

Base type: niem-xsd:string

Field ID: [14.002]

Condition: Mandatory

Defined in: xsd/niem/niem-core/2.0/niem-core.xsd

Special Characters: *n/a*

Maximum Length: 2

Maximum Occurrences: 1

Regular Expression: *n/a*

Namespace: <http://niem.gov/niem/niem-core/2.0>

XPath

```
/it1:PackageFingerprintImageRecord  
  ↙/biom:ImageReferenceIdentification  
    ↙/nc:IdentificationID
```

Summary

IDC assigned to this Type-14 record as listed in 1.003.

Valid Examples

```
<nc:IdentificationID>7</nc:IdentificationID>
```

13.4. Finger Impression Image (XML)

Field Reference: 14/IMP_14/DATA

Content Type: Set_X

XML Tag Name: FingerImpressionImage

Data Type:

Minimum Length:

Minimum Occurrences: 1

Value range: *n/a*

Code table: *n/a*

Base type: biom:FingerImpressionImageType

Field ID: [14.003_14.999]

Condition: Mandatory

Defined in: xsd/niem/biometrics/1.0/biometrics.xsd

Special Characters: *n/a*

Maximum Length:

Maximum Occurrences: 1

Regular Expression: *n/a*

Namespace: <http://niem.gov/niem/biometrics/1.0>

XPath

```
/it1:PackageFingerprintImageRecord  
  ↘/biom:FingerImpressionImage
```

Summary

Image and associated information.

Notes

Applies to 14.003, 14.004, 14.005, 14.006, 14.007, 14.008, 14.009, 14.010, 14.011, 14.012, 14.013, 14.014, 14.015, 14.016, 14.017, 14.018, 14.020, 14.021, 14.022, 14.023, 14.024, 14.025, 14.026, 14.027, 14.030, 14.031, 14.903, 14.904, 14.993, 14.998 and 14.999. XML elements itl:FingerprintImage and itl:PalmpImage are not listed in ANSI/NIST documentation, but are included in the XML schemas to allow for backward compatibility.

13. Fingerprint Image Record (aka Type 14)

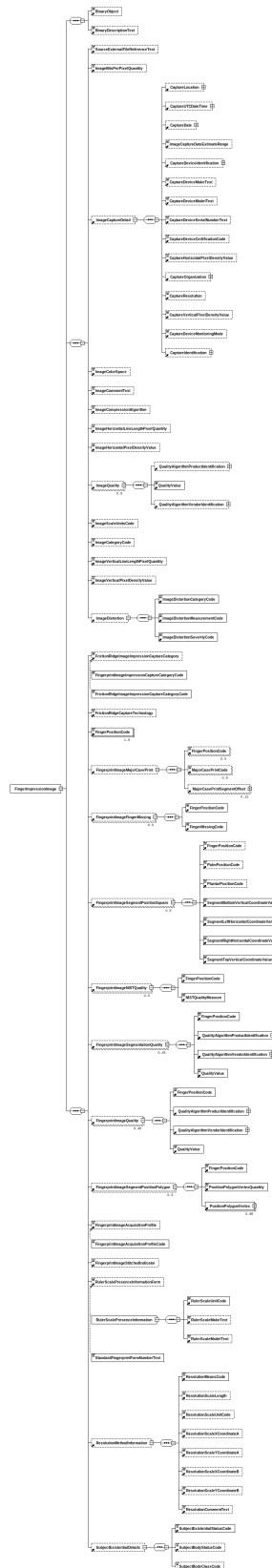

13.5. Impression Type - IMP

 FingerprintImageImpressionCaptureCategoryCode
--

Field Reference: 14/IMP

Content Type: Data

XML Tag Name: FingerprintImageImpressionCaptureCategoryCode

Data Type: N

Minimum Length: 1

Minimum Occurrences: 1

Value range: {0,1,8,24,25,28,29,41,42}

Code table: see table [A.31](#)

Base type: biom:ImpressionCaptureCategoryCodeType

Field ID: [14.003]

Condition: Mandatory

Defined in: xsd/niem/biometrics/1.0/biometrics.xsd

Special Characters: *n/a*

Maximum Length: 2

Maximum Occurrences: 1

Regular Expression: *n/a*

Namespace: <http://niem.gov/niem/biometrics/1.0>

XPath

```
/it1:PackageFingerprintImageRecord
  ↳/biom:FingerImpressionImage
    ↳/biom:FingerprintImageImpressionCaptureCategoryCode
```

Summary

Manner by which the print was obtained.

Valid Examples

<pre><biom:FingerprintImageImpressionCaptureCategoryCode>7</biom:FingerprintImageImpressionCaptureCategoryCode></pre>

13.6. Capture Organization (XML)

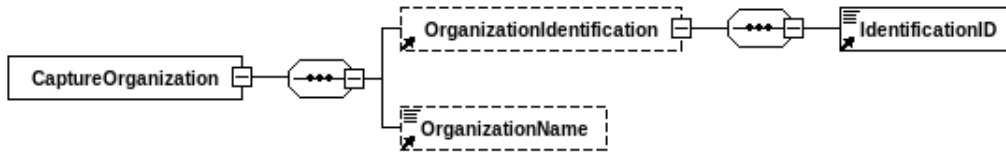

Field Reference: 14/SRC_14/SAN
Content Type: Set_X
XML Tag Name: CaptureOrganization
Data Type:
Minimum Length:
Minimum Occurrences: 1
Value range: *n/a*
Code table: *n/a*
Base type: nc:OrganizationType

Field ID: [14.004_14.993]
Condition: Mandatory
Defined in: xsd/niem/biometrics/1.0/biometrics.xsd
Special Characters: *n/a*
Maximum Length:
Maximum Occurrences: 1
Regular Expression: *n/a*
Namespace: <http://niem.gov/niem/biometrics/1.0>

XPath

```

/itl:PackageFingerprintImageRecord
  ↳/biom:FingerImpressionImage
    ↳/biom:ImageCaptureDetail
      ↳/biom:CaptureOrganization
  
```

Summary

Identifier of agency that created record and supplied information contained in it.

Notes

Applies to 14.004 and 14.993

13.7. Source Agency - SRC

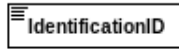

Field Reference: 14/SRC

Content Type: Data

XML Tag Name: IdentificationID

Data Type: U

Minimum Length: 1

Minimum Occurrences: 1

Value range: *n/a*

Code table: *n/a*

Base type: niem-xsd:string

Field ID: [14.004]

Condition: Mandatory

Defined in: xsd/niem/niem-core/2.0/niem-core.xsd

Special Characters: *n/a*

Maximum Length: *

Maximum Occurrences: 1

Regular Expression: *n/a*

Namespace: <http://niem.gov/niem/niem-core/2.0>

XPath

```
/itl:PackageFingerprintImageRecord
  ↳/biom:FingerImpressionImage
    ↳/biom:ImageCaptureDetail
      ↳/biom:CaptureOrganization
        ↳/nc:OrganizationIdentification
          ↳/nc:IdentificationID
```

Summary

Identifier of agency that created and supplied information contained in the record. The source agency name may be entered in 14.993.

Valid Examples

```
<nc:IdentificationID>WI013415Y</nc:IdentificationID>
```

13.8. Fingerprint Capture Date (XML) - FCD



Field Reference: 14/FCD:X
Content Type: Data_X
XML Tag Name: Date
Data Type: NS
Minimum Length: 10
Minimum Occurrences: 1
Value range: *n/a*
Code table: *n/a*
Base type: [niem-xsd:date](#)

Field ID: [14.005:X]
Condition: Mandatory
Defined in: [xsd/niem/niem-core/2.0/niem-core.xsd](#)
Special Characters: [-]
Maximum Length: 10
Maximum Occurrences: 1
Regular Expression: \d{4}-\d{2}-\d{2}
Namespace: <http://niem.gov/niem/niem-core/2.0>

XPath

```

/itl:PackageFingerprintImageRecord
  ↳/biom:FingerImpressionImage
    ↳/biom:ImageCaptureDetail
      ↳/biom:CaptureDate
        ↳/nc:Date
  
```

Summary

Capture date of exemplar fingerprint image data.

Valid Examples

```
<nc:Date>2007-01-01</nc:Date>
```

13.9. Horizontal Line Length - HLL

 ImageHorizontalLineLengthPixelQuantity
--

Field Reference: 14/HLL

Content Type: Data

XML Tag Name: ImageHorizontalLineLengthPixelQuantity

Data Type: N

Minimum Length: 2

Minimum Occurrences: 0

Value range: {10..99999}

Code table: *n/a*

Base type: niem-xsd:integer

Field ID: [14.006]

Condition: Dependent (see table)

Defined in: xsd/niem/biometrics/1.0/biometrics.xsd

Special Characters: *n/a*

Maximum Length: 5

Maximum Occurrences: 1

Regular Expression: *n/a*

Namespace: <http://niem.gov/niem/biometrics/1.0>

Dependency table

Type of dependency	Value
Mandatory on Presence of other Field	14/DATA

XPath

```
/it1:PackageFingerprintImageRecord
└─/biom:FingerImpressionImage
  └─/biom:ImageHorizontalLineLengthPixelQuantity
```

Summary

Number of pixels contained on a single horizontal line of the image.

Valid Examples

```
<biom:ImageHorizontalLineLengthPixelQuantity>5000</biom:ImageHorizontalLineLengthPixelQuantity>
```

13.10. Vertical Line Length - VLL

ImageVerticalLineLengthPixelQuantity

Field Reference: 14/VLL

Content Type: Data

XML Tag Name: ImageVerticalLineLengthPixelQuantity

Data Type: N

Minimum Length: 2

Minimum Occurrences: 0

Value range: {10..99999}

Code table: *n/a*

Base type: niem-xsd:integer

Field ID: [14.007]

Condition: Dependent (see table)

Defined in: xsd/niem/biometrics/1.0/biometrics.xsd

Special Characters: *n/a*

Maximum Length: 5

Maximum Occurrences: 1

Regular Expression: *n/a*

Namespace: <http://niem.gov/niem/biometrics/1.0>

Dependency table

Type of dependency	Value
Mandatory on Presence of other Field	14/DATA

XPath

```
/it1:PackageFingerprintImageRecord
└─/biom:FingerImpressionImage
  └─/biom:ImageVerticalLineLengthPixelQuantity
```

Summary

Number of pixels contained on a single vertical line of the image.

Valid Examples

```
<biom:ImageVerticalLineLengthPixelQuantity>2500</biom:ImageVerticalLineLengthPixelQuantity>
```

13.11. Scale Units - SLC

ImageScaleUnitsCode

Field Reference: 14/SLC

Content Type: Data

XML Tag Name: ImageScaleUnitsCode

Data Type: N

Minimum Length: 1

Minimum Occurrences: 0

Value range: {1}

Code table: see table [A.59](#)

Base type: biom:ScaleUnitsCodeType

Field ID: [14.008]

Condition: Dependent (see table)

Defined in: xsd/niem/biometrics/1.0/biometrics.xsd

Special Characters: *n/a*

Maximum Length: 1

Maximum Occurrences: 1

Regular Expression: *n/a*

Namespace: <http://niem.gov/niem/biometrics/1.0>

Dependency table

Type of dependency	Value
Mandatory on Presence of other Field	14/DATA

XPath

```
/it1:PackageFingerprintImageRecord
  ↙/biom:FingerImpressionImage
    ↙/biom:ImageScaleUnitsCode
```

Summary

Image sampling frequency (pixel density).

Notes

Only code 1 (ppi) is allowed in INTERPOL's implementation.

Valid Examples

```
<biom:ImageScaleUnitsCode>1</biom:ImageScaleUnitsCode>
```

13.12. Transmitted Horizontal Pixel Scale - THPS



Field Reference: 14/THPS	Field ID: [14.009]
Content Type: Data	Condition: Dependent (see table)
XML Tag Name: ImageHorizontalPixelDensityValue	Defined in: xsd/niem/biometrics/1.0/biometrics.xsd
Data Type: N	Special Characters: <i>n/a</i>
Minimum Length: 1	Maximum Length: 5
Minimum Occurrences: 0	Maximum Occurrences: 1
Value range: {1000,500}	Regular Expression: <i>n/a</i>
Code table: <i>n/a</i>	
Base type: niem-xsd:nonNegativeInteger	Namespace: http://niem.gov/niem/biometrics/1.0

Dependency table

Type of dependency	Value
Mandatory on Presence of other Field	14/DATA

XPath

```
/it1:PackageFingerprintImageRecord
  ↳/biom:FingerImpressionImage
    ↳/biom:ImageHorizontalPixelDensityValue
```

Summary

Integer pixel density in the horizontal direction (if 14/SLC = 1 or 2); otherwise, if 14/SLC = 0, the horizontal component of the pixel aspect ratio.

Notes

For example, if the SLC value = 1, then the value of THPS could be '1000' for a 1000 ppi sensor.

Technical Notes

If 14/SLC=1,2, then THPS shall equal TVPS.

Valid Examples

```
<biom:ImageHorizontalPixelDensityValue>1000</biom:ImageHorizontalPixelDensityValue>
```

13.13. Transmitted Vertical Pixel Scale - TVPS

ImageVerticalPixelDensityValue

Field Reference: 14/TVPS

Content Type: Data

XML Tag Name: ImageVerticalPixelDensityValue

Data Type: N

Minimum Length: 1

Minimum Occurrences: 0

Value range: {1000,500}

Code table: *n/a*

Base type: niem-xsd:nonNegativeInteger

Field ID: [14.010]

Condition: Dependent (see table)

Defined in: xsd/niem/biometrics/1.0/biometrics.xsd

Special Characters: *n/a*

Maximum Length: 5

Maximum Occurrences: 1

Regular Expression: *n/a*

Namespace: <http://niem.gov/niem/biometrics/1.0>

Dependency table

Type of dependency	Value
Mandatory on Presence of other Field	14/DATA

XPath

```
/it1:PackageFingerprintImageRecord
  ↳/biom:FingerImpressionImage
    ↳/biom:ImageVerticalPixelDensityValue
```

Summary

Integer pixel density in the vertical direction (if 14/SLC = 1 or 2); otherwise, if 14/SLC = 0, the vertical component of the pixel aspect ratio.

Technical Notes

If 14/SLC=1,2, then THPS shall equal TVPS.

Valid Examples

```
<biom:ImageVerticalPixelDensityValue>1000</biom:ImageVerticalPixelDensityValue>
```

13.14. Compression Algorithm - CGA

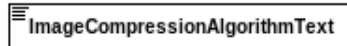

Field Reference: 14/CGA

Content Type: Data

XML Tag Name: ImageCompressionAlgorithmText

Data Type: AN

Minimum Length: 3

Minimum Occurrences: 0

Value range: {"JP2", "JP2L", "WSQ20"}

Code table: see table A.6

Base type: nc:TextType

Field ID: [14.011]

Condition: Dependent (see table)

Defined in: xsd/niem/biometrics/1.0/biometrics.xsd

Special Characters: *n/a*

Maximum Length: 5

Maximum Occurrences: 1

Regular Expression: *n/a*

Namespace: <http://niem.gov/niem/biometrics/1.0>

Dependency table

Type of dependency	Value
Mandatory on Presence of other Field	14/DATA

XPath

```
/it1:PackageFingerprintImageRecord
  ↳/biom:FingerImpressionImage
    ↳/biom:ImageCompressionAlgorithmText
```

Summary

Algorithm used to compress the transmitted grayscale images.

Notes

INTERPOL standard restricts the possible formats to the following ones, depending on the image resolution:

500ppi images WSQ

1000ppi images JPEG 2000 lossless, or JPEG 2000 lossy, with a compression ratio of 10:1

Valid Examples

```
<biom:ImageCompressionAlgorithmText>NONE</biom:ImageCompressionAlgorithmText>
```

13.15. Bits Per Pixel - BPX

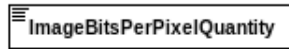

Field Reference: 14/BPX

Content Type: Data

XML Tag Name: ImageBitsPerPixelQuantity

Data Type: N

Minimum Length: 1

Minimum Occurrences: 0

Value range: {8}

Code table: *n/a*

Base type: niem-xsd:nonNegativeInteger

Field ID: [14.012]

Condition: Dependent (see table)

Defined in: xsd/niem/biometrics/1.0/biometrics.xsd

Special Characters: *n/a*

Maximum Length: 2

Maximum Occurrences: 1

Regular Expression: *n/a*

Namespace: <http://niem.gov/niem/biometrics/1.0>

Dependency table

Type of dependency	Value
Mandatory on Presence of other Field	14/DATA

XPath

```
/it1:PackageFingerprintImageRecord
  ↳/biom:FingerImpressionImage
    ↳/biom:ImageBitsPerPixelQuantity
```

Summary

Number of bits per pixel.

Notes

This field shall contain an entry of "8" for normal grayscale values of "0" to "255". Any entry in this field greater than "8" shall be used to represent a grayscale pixel with increased proportion. For color, BPX represents the total number of bits per pixel (not per color). For instance, BPX=24 represents a 24-bit RGB image using 8 bits for each color.

INTERPOL's implementation only supports 8-bit grayscale images.

Valid Examples

```
<biom:ImageBitsPerPixelQuantity>8</biom:ImageBitsPerPixelQuantity>
```

13.16. Friction Ridge Generalized Position - FGP

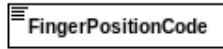

Field Reference: 14/FGP

Content Type: Data

XML Tag Name: FingerPositionCode

Data Type: N

Minimum Length: 1

Minimum Occurrences: 1

Value range: {1..14}

Code table: see table [A.25](#) and table [A.26](#)

Base type: biom:FingerPositionCodeType

Field ID: [14.013]

Condition: Mandatory

Defined in: xsd/niem/biometrics/1.0/biometrics.xsd

Special Characters: *n/a*

Maximum Length: 2

Maximum Occurrences: 1

Regular Expression: *n/a*

Namespace: <http://niem.gov/niem/biometrics/1.0>

XPath

```
/it1:PackageFingerprintImageRecord
  ↙/biom:FingerImpressionImage
    ↙/biom:FingerPositionCode
```

Summary

Friction ridge generalized position.

Notes

INTERPOL's implementation only allows FGP between 1 and 15. Extra fingers, unknown fingers, ... are not accepted.

Valid Examples

```
<biom:FingerPositionCode>9</biom:FingerPositionCode>
```

13.17. Amputated or Bandaged - AMP

Field Reference: 14/AMP

Content Type: Set

XML Tag Name: FingerprintImageFingerMissing

Data Type:

Minimum Length:

Minimum Occurrences: 0

Value range: *n/a*

Code table: *n/a*

Base type: biom:FingerprintImageFingerMissingType

Field ID: [14.018]

Condition: Optional

Defined in: xsd/niem/biometrics/1.0/biometrics.xsd

Special Characters: *n/a*

Maximum Length:

Maximum Occurrences: 5

Regular Expression: *n/a*

Namespace: <http://niem.gov/niem/biometrics/1.0>

XPath

```
/it1:PackageFingerprintImageRecord
  ↳/biom:FingerImpressionImage
    ↳/biom:FingerprintImageFingerMissing
```

Summary

Specifies if one or more fingers are amputated or bandaged. This field is to be used anytime there are fewer than expected printable fingers in a submission (e.g., less than four in a left or right slap or less than two in a two-thumb slap).

13.18. Friction Ridge Amputated or Bandaged Position - FRAP

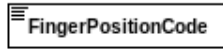

Field Reference: 14/AMP/FRAP

Content Type: Data

XML Tag Name: FingerPositionCode

Data Type: N

Minimum Length: 1

Minimum Occurrences: 1

Value range: {1..10}

Code table: see table [A.25](#) and table [A.26](#)

Base type: biom:FingerPositionCodeType

Field ID: [14.018-A]

Condition: Mandatory within a field

Defined in: xsd/niem/biometrics/1.0/biometrics.xsd

Special Characters: *n/a*

Maximum Length: 2

Maximum Occurrences: 1

Regular Expression: *n/a*

Namespace: <http://niem.gov/niem/biometrics/1.0>

XPath

```
/it1:PackageFingerprintImageRecord
  ↳/biom:FingerImpressionImage
    ↳/biom:FingerprintImageFingerMissing
      ↳/biom:FingerPositionCode
```

Summary

Friction ridge amputated or bandaged position.

Notes

Even though the ANSI-NIST standard allows codes 16 and 17 (right and left extra fingers), these codes are not allowed in the INTERPOL implementation.

Valid Examples

```
<biom:FingerPositionCode>8</biom:FingerPositionCode>
```

13.19. Amputated or Bandaged Code - ABC

Field Reference: 14/AMP/ABC

Content Type: Data

XML Tag Name: FingerMissingCode

Data Type: A

Minimum Length: 2

Minimum Occurrences: 1

Value range: {"XX","UP"}

Code table: see table [A.1](#)

Base type: biom:FrictionRidgeImageMissingAreaReasonCodeType **Namespace:** <http://niem.gov/niem/biometrics/1.0>

Field ID: [14.018-B]

Condition: Mandatory within a field

Defined in: xsd/niem/biometrics/1.0/biometrics.xsd

Special Characters: *n/a*

Maximum Length: 2

Maximum Occurrences: 1

Regular Expression: *n/a*

XPath

```
/itl:PackageFingerprintImageRecord
  ↙/biom:FingerImpressionImage
    ↙/biom:FingerprintImageFingerMissing
      ↙/biom:FingerMissingCode
```

Summary

Code describing amputation or bandaged friction ridge area.

Notes

XX shall be used only when a partial print exists due to amputation; therefore it contains some friction ridge detail. (The finger is not totally amputated, some countries might qualify such print as "mutilated")

UP shall be used with the complete block where an image was to be transmitted, but there is no image due to amputation or total lack of friction ridge detail (such as with a bandage).

An image with a scar should not be marked XX or UP, the 14.018 field should not be present. The SR (scar) code of the ANSI-NIST standard should not be used in INTERPOL's implementation.

Note that if a finger has simply not been acquired (for instance in the case of a 2-finger acquisition), no type 14 should be created for this finger.

Valid Examples

```
<biom:FingerMissingCode>UP</biom:FingerMissingCode>
```

13.20. Finger Segment Position - SEG



Field Reference: 14/SEG

Content Type: Set

XML Tag Name: FingerImageSegmentPositionSquare

Data Type:

Minimum Length:

Minimum Occurrences: 0

Value range: *n/a*

Code table: *n/a*

Base type: biom:FrictionRidgeImageSegmentPositionSquareType

Field ID: [14.021]

Condition: Dependent (see table)

Defined in: xsd/niem/biometrics/1.0/biometrics.xsd

Special Characters: *n/a*

Maximum Length:

Maximum Occurrences: 4

Regular Expression: *n/a*

Namespace: <http://niem.gov/niem/biometrics/1.0>

Exceptions

see Technical Notes below

Dependency table

Type of dependency	Value
Optional on Value of other Field, should not be set otherwise.	[14/FGP]IN{13,14}

XPath

```

/it1:PackageFingerprintImageRecord
  ↳/biom:FingerImpressionImage
    ↳/biom:FingerImageSegmentPositionSquare
  
```

13. Fingerprint Image Record (aka Type 14)

Summary

Offsets to the locations of image segments containing the individual fingers within the flat images of simultaneous fingers from each hand or the two simultaneous thumbs.

Notes

If the segmentation information are present, it is up to the receiving system to decide whether or not it will be used. There is hence no guaranty that the receiving system will use the same segmentation as the emitting one.

Technical Notes

INTERPOL's implementation is more restrictive than the umbrella standard and only allow the transmission of segmentation information for the left and right four-finger images. This field must not be used for the other images.

In case of a slap-only acquisition (no rolled images), this is not enough to transmit the 4 images (2 4-finger slap images and 2 plain 1-thumb image) with the segmentation information; the segmented individual flat finger images must also be sent in their own Type 14 as well. If rolled finger images are part of the acquisition, then the segmented individual flat finger extracted from the slap images must not be included.

13.21. Friction Ridge Segment Position - FRSP

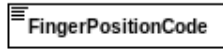

Field Reference: 14/SEG/FRSP

Content Type: Data

XML Tag Name: FingerPositionCode

Data Type: N

Minimum Length: 1

Minimum Occurrences: 1

Value range: {1..10}

Code table: see table [A.25](#) and table [A.26](#)

Base type: biom:FingerPositionCodeType

Field ID: [14.021-A]

Condition: Mandatory within a field

Defined in: xsd/niem/biometrics/1.0/biometrics.xsd

Special Characters: *n/a*

Maximum Length: 2

Maximum Occurrences: 1

Regular Expression: *n/a*

Namespace: <http://niem.gov/niem/biometrics/1.0>

XPath

```
/it1:PackageFingerprintImageRecord
  ↳/biom:FingerImpressionImage
    ↳/biom:FingerprintImageSegmentPositionSquare
      ↳/biom:FingerPositionCode
```

Summary

Code indicating the location or position of the friction ridge segment.

Valid Examples

```
<biom:FingerPositionCode>2</biom:FingerPositionCode>
```

13.22. Left Horizontal Coordinate Value - LHC

 SegmentLeftHorizontalCoordinateValue

Field Reference: 14/SEG/LHC

Content Type: Data

XML Tag Name: SegmentLeftHorizontalCoordinateValue

Data Type: N

Minimum Length: 1

Minimum Occurrences: 1

Value range: *n/a*

Code table: *n/a*

Base type: niem-xsd:nonNegativeInteger

Field ID: [14.021-B]

Condition: Mandatory within a field

Defined in: xsd/niem/biometrics/1.0/biometrics.xsd

Special Characters: *n/a*

Maximum Length: 5

Maximum Occurrences: 1

Regular Expression: *n/a*

Namespace: <http://niem.gov/niem/biometrics/1.0>

XPath

```
/it1:PackageFingerprintImageRecord
└─/biom:FingerImpressionImage
  └─/biom:FingerprintImageSegmentPositionSquare
    └─/biom:SegmentLeftHorizontalCoordinateValue
```

Summary

Horizontal offset in pixels to the left edge of the bounding box relative to the origin positioned in the upper left corner of the image.

Valid Examples

```
<biom:SegmentLeftHorizontalCoordinateValue>50</biom:SegmentLeftHorizontalCoordinateValue>
```

13.23. Right Horizontal Coordinate Value - RHC

 SegmentRightHorizontalCoordinateValue

Field Reference: 14/SEG/RHC

Content Type: Data

XML Tag Name: SegmentRightHorizontalCoordinateValue

Data Type: N

Minimum Length: 1

Minimum Occurrences: 1

Value range: *n/a*

Code table: *n/a*

Base type: niem-xsd:nonNegativeInteger

Field ID: [14.021-C]

Condition: Mandatory within a field

Defined in: xsd/niem/biometrics/1.0/biometrics.xsd

Special Characters: *n/a*

Maximum Length: 5

Maximum Occurrences: 1

Regular Expression: *n/a*

Namespace: <http://niem.gov/niem/biometrics/1.0>

XPath

```
/it1:PackageFingerprintImageRecord
  ↳/biom:FingerImpressionImage
    ↳/biom:FingerprintImageSegmentPositionSquare
      ↳/biom:SegmentRightHorizontalCoordinateValue
```

Summary

Horizontal offset in pixels to the right edge of the bounding box relative to the origin positioned in the upper left corner of the image.

Valid Examples

```
<biom:SegmentRightHorizontalCoordinateValue>10</biom:SegmentRightHorizontalCoordinateValue>
```

13.24. Top Vertical Coordinate Value - TVC

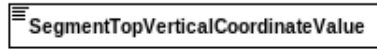

Field Reference: 14/SEG/TVC

Content Type: Data

XML Tag Name: SegmentTopVerticalCoordinateValue

Data Type: N

Minimum Length: 1

Minimum Occurrences: 1

Value range: *n/a*

Code table: *n/a*

Base type: niem-xsd:nonNegativeInteger

Field ID: [14.021-D]

Condition: Mandatory within a field

Defined in: xsd/niem/biometrics/1.0/biometrics.xsd

Special Characters: *n/a*

Maximum Length: 5

Maximum Occurrences: 1

Regular Expression: *n/a*

Namespace: <http://niem.gov/niem/biometrics/1.0>

XPath

```
/it1:PackageFingerprintImageRecord
  ↳/biom:FingerImpressionImage
    ↳/biom:FingerprintImageSegmentPositionSquare
      ↳/biom:SegmentTopVerticalCoordinateValue
```

Summary

Vertical offset (pixel counts down) to the top of the bounding box.

Valid Examples

```
<biom:SegmentTopVerticalCoordinateValue>30</biom:SegmentTopVerticalCoordinateValue>
```

13.25. Bottom Vertical Coordinate Value - BVC

SegmentBottomVerticalCoordinateValue

Field Reference: 14/SEG/BVC

Content Type: Data

XML Tag Name: SegmentBottomVerticalCoordinateValue

Data Type: N

Minimum Length: 1

Minimum Occurrences: 1

Value range: *n/a*

Code table: *n/a*

Base type: niem-xsd:nonNegativeInteger

Field ID: [14.021-E]

Condition: Mandatory within a field

Defined in: xsd/niem/biometrics/1.0/biometrics.xsd

Special Characters: *n/a*

Maximum Length: 5

Maximum Occurrences: 1

Regular Expression: *n/a*

Namespace: <http://niem.gov/niem/biometrics/1.0>

XPath

```
/it1:PackageFingerprintImageRecord
└─/biom:FingerImpressionImage
  └─/biom:FingerprintImageSegmentPositionSquare
    └─/biom:SegmentBottomVerticalCoordinateValue
```

Summary

Vertical offset (in pixels) from the upper left corner of the image down to the bottom of the bounding box.

Valid Examples

```
<biom:SegmentBottomVerticalCoordinateValue>10</biom:SegmentBottomVerticalCoordinateValue>
```

13.26. Alternate Finger Segment Position(s) - ASEG

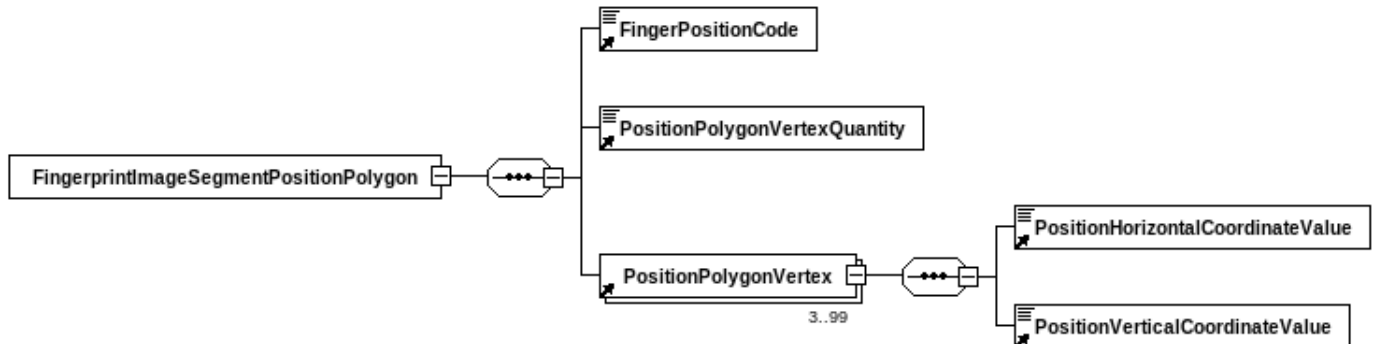

Field Reference: 14/ASEG

Content Type: Set

XML Tag Name: FingerImageSegmentPositionPolygon

Data Type:

Minimum Length:

Minimum Occurrences: 0

Value range: *n/a*

Code table: *n/a*

Base type: biom:FingerImageSegmentPositionPolygonType

Field ID: [14.025]

Condition: Dependent (see table)

Defined in: xsd/niem/biometrics/1.0/biometrics.xsd

Special Characters: *n/a*

Maximum Length:

Maximum Occurrences: 4

Regular Expression: *n/a*

Namespace: <http://niem.gov/niem/biometrics/1.0>

Exceptions

see Technical Notes below

Dependency table

Type of dependency	Value
Optional on Value of other Field, should not be set otherwise.	[14/FGP]IN{13,14}

XPath

```
/itl:PackageFingerprintImageRecord
  ↳/biom:FingerImpressionImage
    ↳/biom:FingerImageSegmentPositionPolygon
```

Summary

Alternate approach to describing the locations for each of the image segments of each of the individual fingers within a flat image containing the capture of four (or more if extra digits exist on the hand) simultaneous fingers or two simultaneous thumbs.

Notes

The order of the vertices shall be in their consecutive order around the perimeter of the polygon, either clockwise or counterclockwise. No two vertices may occupy the same location. The polygon side defined by the last vertex and the first vertex shall complete the polygon. The polygon shall be a simple, plane figure with no sides crossing and no interior holes.

If the segmentation information are present, it is up to the receiving system to decide whether or not it will be used. There is hence no guaranty that the receiving system will use the same segmentation as the emitting one.

13. Fingerprint Image Record (aka Type 14)

Technical Notes

INTERPOL's implementation is more restrictive than the umbrella standard and only allow the transmission of segmentation information for the left and right four-finger images. This field must not be used for the other images.

In case of a slap-only acquisition (no rolled images), this is not enough to transmit the 4 images (2 4-finger slap images and 2 plain 1-thumb image) with the segmentation information; the segmented individual flat finger images must also be sent in their own Type 14 as well. If rolled finger images are part of the acquisition, then the segmented individual flat finger extracted from the slap images must not be included.

Finally, while the umbrella standard allows to define the segmentation as an up-to-99 vertices polygon, INTERPOL's implementation restrict that to rectangle.

13.27. Friction Ridge Alternate Segment Position - FRAS

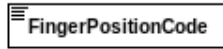

Field Reference: 14/ASEG/FRAS

Content Type: Data

XML Tag Name: FingerPositionCode

Data Type: N

Minimum Length: 1

Minimum Occurrences: 1

Value range: {1..10}

Code table: see table [A.25](#) and table [A.26](#)

Base type: biom:FingerPositionCodeType

Field ID: [14.025-A]

Condition: Mandatory within a field

Defined in: xsd/niem/biometrics/1.0/biometrics.xsd

Special Characters: *n/a*

Maximum Length: 2

Maximum Occurrences: 1

Regular Expression: *n/a*

Namespace: <http://niem.gov/niem/biometrics/1.0>

XPath

```
/it1:PackageFingerprintImageRecord
  ↳/biom:FingerImpressionImage
    ↳/biom:FingerprintImageSegmentPositionPolygon
      ↳/biom:FingerPositionCode
```

Summary

Finger number from Table 8.

Valid Examples

```
<biom:FingerPositionCode>8</biom:FingerPositionCode>
```

13.28. Number of Points - NOP

PositionPolygonVertexQuantity

Field Reference: 14/ASEG/NOP

Content Type: Data

XML Tag Name: PositionPolygonVertexQuantity

Data Type: N

Minimum Length: 1

Minimum Occurrences: 1

Value range: {4}

Code table: *n/a*

Base type: niem-xsd:nonNegativeInteger

Field ID: [14.025-B]

Condition: Mandatory within a field

Defined in: xsd/niem/biometrics/1.0/biometrics.xsd

Special Characters: *n/a*

Maximum Length: 2

Maximum Occurrences: 1

Regular Expression: *n/a*

Namespace: <http://niem.gov/niem/biometrics/1.0>

XPath

```
/itl:PackageFingerprintImageRecord
└─/biom:FingerImpressionImage
  └─/biom:FingerprintImageSegmentPositionPolygon
    └─/biom:PositionPolygonVertexQuantity
```

Summary

Number of vertices for the occlusion polygon.

Valid Examples

```
<biom:PositionPolygonVertexQuantity>4</biom:PositionPolygonVertexQuantity>
```

13.29. Position Polygon Vertex (XML)

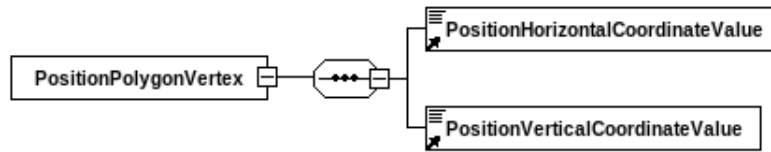

Field Reference: 14/ASEG/HPO_14/ASEG/VPO
Content Type: Set_X
XML Tag Name: PositionPolygonVertex
Data Type:
Minimum Length:
Minimum Occurrences: 3
Value range: *n/a*
Code table: *n/a*
Base type: biom:VertexType

Field ID: [14.025-C_14.025-D]
Condition: Mandatory within a field
Defined in: xsd/niem/biometrics/1.0/biometrics.xsd
Special Characters: *n/a*
Maximum Length:
Maximum Occurrences: 4
Regular Expression: *n/a*
Namespace: <http://niem.gov/niem/biometrics/1.0>

XPath

```
/itl:PackageFingerprintImageRecord
  ↳/biom:FingerImpressionImage
    ↳/biom:FingerprintImageSegmentPositionPolygon
      ↳/biom:PositionPolygonVertex
```

Summary

Number of polygon vertices/coordinate pairs.

Notes

Applies to 14.025-C and 14.025-D

13.30. Horizontal Point Offset (XML) - HPO

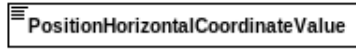

Field Reference: 14/ASEG/HPO:X

Content Type: Data_X

XML Tag Name: PositionHorizontalCoordinateValue

Data Type: N

Minimum Length: 1

Minimum Occurrences: 1

Value range: *n/a*

Code table: *n/a*

Base type: niem-xsd:nonNegativeInteger

Field ID: [14.025-C:X]

Condition: Mandatory within a field

Defined in: xsd/niem/biometrics/1.0/biometrics.xsd

Special Characters: *n/a*

Maximum Length: 5

Maximum Occurrences: 1

Regular Expression: *n/a*

Namespace: <http://niem.gov/niem/biometrics/1.0>

XPath

```
/itl:PackageFingerprintImageRecord
├─/biom:FingerImpressionImage
│  └─/biom:FingerprintImageSegmentPositionPolygon
│     └─/biom:PositionPolygonVertex
│        └─/biom:PositionHorizontalCoordinateValue
```

Summary

Pixel count to the right (x coordinate).

Valid Examples

```
<biom:PositionHorizontalCoordinateValue>100</biom:PositionHorizontalCoordinateValue>
```

13.31. Vertical Point Offset (XML) - VPO

PositionVerticalCoordinateValue

Field Reference: 14/ASEG/VPO:X**Content Type:** Data_X**XML Tag Name:** PositionVerticalCoordinateValue**Data Type:** N**Minimum Length:** 1**Minimum Occurrences:** 1**Value range:** *n/a***Code table:** *n/a***Base type:** niem-xsd:nonNegativeInteger**Field ID:** [14.025-D:X]**Condition:** Mandatory within a field**Defined in:** xsd/niem/biometrics/1.0/biometrics.xsd**Special Characters:** *n/a***Maximum Length:** 5**Maximum Occurrences:** 1**Regular Expression:** *n/a***Namespace:** <http://niem.gov/niem/biometrics/1.0>**XPath**

```

/itl:PackageFingerprintImageRecord
  ↳/biom:FingerImpressionImage
    ↳/biom:FingerprintImageSegmentPositionPolygon
      ↳/biom:PositionPolygonVertex
        ↳/biom:PositionVerticalCoordinateValue

```

Summary

Pixel count down from the origin (y coordinate).

Valid Examples

```
<biom:PositionVerticalCoordinateValue>15</biom:PositionVerticalCoordinateValue>
```

13.32. Device Monitoring Mode - DMM

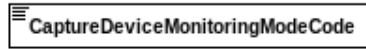

Field Reference: 14/DMM

Content Type: Data

XML Tag Name: CaptureDeviceMonitoringModeCode

Data Type: A

Minimum Length: 7

Minimum Occurrences: 0

Value range: *n/a*

Code table: see table [A.17](#)

Base type: biom:DeviceMonitoringModeCodeType

Field ID: [14.030]

Condition: Optional

Defined in: xsd/niem/biometrics/1.0/biometrics.xsd

Special Characters: *n/a*

Maximum Length: 10

Maximum Occurrences: 1

Regular Expression: *n/a*

Namespace: <http://niem.gov/niem/biometrics/1.0>

XPath

```
/it1:PackageFingerprintImageRecord
  ↳/biom:FingerImpressionImage
    ↳/biom:ImageCaptureDetail
      ↳/biom:CaptureDeviceMonitoringModeCode
```

Summary

Level of human monitoring associated with biometric sample capture.

Valid Examples

```
<biom:CaptureDeviceMonitoringModeCode>ASSISTED</biom:CaptureDeviceMonitoringModeCode>
```

13.33. Subject Acquisition Profile - Fingerprint - FAP

 FingerprintImageAcquisitionProfileCode

Field Reference: 14/FAP

Content Type: Data

XML Tag Name: FingerprintImageAcquisitionProfileCode

Data Type: N

Minimum Length: 2

Minimum Occurrences: 0

Value range: *n/a*

Code table: see table [A.23](#)

Base type: biom:FingerprintImageAcquisitionProfileCodeType

Field ID: [14.031]

Condition: Optional

Defined in: xsd/niem/biometrics/1.0/biometrics.xsd

Special Characters: *n/a*

Maximum Length: 2

Maximum Occurrences: 1

Regular Expression: *n/a*

Namespace: <http://niem.gov/niem/biometrics/1.0>

XPath

```
/it1:PackageFingerprintImageRecord
  ↳/biom:FingerImpressionImage
    ↳/biom:FingerprintImageAcquisitionProfileCode
```

Summary

FAP level associated with the fingerprint acquisition device.

Notes

Even if there is no control of the acquisition profile, It is recommended to use devices that permit an acquisition profile of 45 or better.

Valid Examples

```
<biom:FingerprintImageAcquisitionProfileCode>20</biom:FingerprintImageAcquisitionProfileCode>
```

13.34. Friction Ridge Capture Technology - FCT

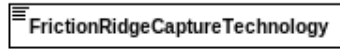

Field Reference: 14/FCT	Field ID: [14.901]
Content Type: Data_X	Condition: Optional
XML Tag Name: FrictionRidgeCaptureTechnology	Defined in: xsd/niem/biometrics/1.0/biometrics.xsd
Data Type: N	Special Characters: <i>n/a</i>
Minimum Length: 1	Maximum Length: 2
Minimum Occurrences: 0	Maximum Occurrences: 1
Value range: {0..7,9..17}	Regular Expression: <i>n/a</i>
Code table: see table A.24	
Base type: biom:FrictionRidgeCaptureTechnologyType	Namespace: http://niem.gov/niem/biometrics/1.0

XPath

```
/it1:PackageFingerprintImageRecord  
  ↘/biom:FingerImpressionImage  
    ↘/biom:FrictionRidgeCaptureTechnology
```

Summary

The technology used to capture friction ridge data

Valid Examples

```
<biom:FrictionRidgeCaptureTechnology>0</biom:FrictionRidgeCaptureTechnology>
```

13.35. Fingerprint Image - DATA

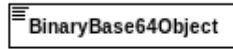

Field Reference: 14/DATA

Content Type: Data

XML Tag Name: BinaryBase64Object

Data Type: B

Minimum Length: 1

Minimum Occurrences: 0

Value range: *n/a*

Code table: *n/a*

Base type: niem-xsd:base64Binary

Field ID: [14.999]

Condition: Dependent (see table)

Defined in: xsd/niem/niem-core/2.0/niem-core.xsd

Special Characters: *n/a*

Maximum Length: *

Maximum Occurrences: 1

Regular Expression: *n/a*

Namespace: <http://niem.gov/niem/niem-core/2.0>

Dependency table

Type of dependency	Value
Other Dependency	This field is mandatory in all cases, except for when 14/AMP={"UP"}. When 14/AMP={"UP"}, the field is optional.

XPath

```
/it1:PackageFingerprintImageRecord
  ↙/biom:FingerImpressionImage
    ↙/nc:BinaryBase64Object
```

Summary

Contains the fingerprint image.

Notes

Binary for Traditional encoding or Base64 for XML

Technical Notes

This field is mandatory in all cases, except for when 14/AMP="UP". When 14/AMP="UP", the field is optional.

Valid Examples

```
<nc:BinaryBase64Object>mrHbPdrko3u1s7ahtgPBjtm01s85tfG2U7bpofY94Czu2SbY7d7wF9fQ7ZptgGrtk02a2dsJ7wZbe8BlzvAmQ7xq+
Y94GoHeEsR3ikWd4DIGhzmp3k42d4DRmzs94DKveDTB3hqw6PeBLrtpPep0H/+h</nc:BinaryBase64Object>
```

13.36. Field Mandatoriness in Fingerprint Image Record

The following table shows a summary of the fields and information items in each record type and its corresponding XML elements, and in particular the fields and items that are mandatory.

Table 13.1.: Field Summary for Type 14 Records

Field Id	Code	Field Name	Card.	Notes
14/XRCC:X	[14.001:X]	XML Record Category Code	M	
14/IDC	[14.002]	Information Designation Character	M	
14/IMP_14/DATA	[14.003_14.999]	Finger Impression Image (XML)	M	
14/IMP	[14.003]	Impression Type	M	
14/SRC_14/SAN	[14.004_14.993]	Capture Organization (XML)	M	
14/SRC	[14.004]	Source Agency	M	
14/FCD:X	[14.005:X]	Fingerprint Capture Date (XML)	M	
14/HLL	[14.006]	Horizontal Line Length	D	This field is required (and not permitted otherwise) if 14/DATA is/are present.
14/VLL	[14.007]	Vertical Line Length	D	This field is required (and not permitted otherwise) if 14/DATA is/are present.
14/SLC	[14.008]	Scale Units	D	This field is required (and not permitted otherwise) if 14/DATA is/are present.
14/THPS	[14.009]	Transmitted Horizontal Pixel Scale	D	This field is required (and not permitted otherwise) if 14/DATA is/are present.
14/TVPS	[14.010]	Transmitted Vertical Pixel Scale	D	This field is required (and not permitted otherwise) if 14/DATA is/are present.
14/CGA	[14.011]	Compression Algorithm	D	This field is required (and not permitted otherwise) if 14/DATA is/are present.
14/BPX	[14.012]	Bits Per Pixel	D	This field is required (and not permitted otherwise) if 14/DATA is/are present.
14/FGP	[14.013]	Friction Ridge Generalized Position	M	
14/AMP	[14.018]	Amputated or Bandaged	O	
14/AMP/FRAP	[14.018-A]	Friction Ridge Amputated or Bandaged Position	M^	
14/AMP/ABC	[14.018-B]	Amputated or Bandaged Code	M^	

M=Mandatory, O=Optional, M^=Mandatory Info Item within a Field, O^=Optional Info Item within a Field, D=Dependent on other Fields/Info Items

13. Fingerprint Image Record (aka Type 14)

Table 13.1.: Field Summary for Type 14 Records

Field Id	Code	Field Name	Card.	Notes
14/SEG	[14.021]	Finger Segment Position	D	<ul style="list-style-type: none"> This field is optional (and should not be entered otherwise) if [14/FGP]IN{13,14} INTERPOL's implementation is more restrictive than the umbrella standard and only allow the transmission of segmentation information for the left and right four-finger images. This field must not be used for the other images. <p>In case of a slap-only acquisition (no rolled images), this is not enough to transmit the 4 images (2 4-finger slap images and 2 plain 1-thumb image) with the segmentation information; the segmented individual flat finger images must also be sent in their own Type 14 as well. If rolled finger images are part of the acquisition, then the segmented individual flat finger extracted from the slap images must not be included.</p>
14/SEG/FRSP	[14.021-A]	Friction Ridge Segment Position	M^	
14/SEG/LHC	[14.021-B]	Left Horizontal Coordinate Value	M^	
14/SEG/RHC	[14.021-C]	Right Horizontal Coordinate Value	M^	
14/SEG/TVC	[14.021-D]	Top Vertical Coordinate Value	M^	
14/SEG/BVC	[14.021-E]	Bottom Vertical Coordinate Value	M^	

M=Mandatory, O=Optional, M^=Mandatory Info Item within a Field, O^=Optional Info Item within a Field, D=Dependent on other Fields/Info Items

13. Fingerprint Image Record (aka Type 14)

Table 13.1.: Field Summary for Type 14 Records

Field Id	Code	Field Name	Card.	Notes
14/ASEG	[14.025]	Alternate Finger Segment Position(s)	D	<ul style="list-style-type: none"> This field is optional (and should not be entered otherwise) if [14/FGP]IN{13,14} INTERPOL's implementation is more restrictive than the umbrella standard and only allow the transmission of segmentation information for the left and right four-finger images. This field must not be used for the other images. <p>In case of a slap-only acquisition (no rolled images), this is not enough to transmit the 4 images (2 4-finger slap images and 2 plain 1-thumb image) with the segmentation information; the segmented individual flat finger images must also be sent in their own Type 14 as well.</p> <p>If rolled finger images are part of the acquisition, then the segmented individual flat finger extracted from the slap images must not be included.</p> <p>Finally, while the umbrella standard allows to define the segmentation as an up-to-99 vertices polygon, INTERPOL's implementation restrict that to rectangle.</p>
14/ASEG/FRAS	[14.025-A]	Friction Ridge Alternate Segment Position	M [^]	
14/ASEG/NOP	[14.025-B]	Number of Points	M [^]	
14/ASEG/HPO_14/ASEG/VF	[14.025-C_14.025-D]	Position Polygon Vertex (XML)	M [^]	
14/ASEG/HPO:X	[14.025-C:X]	Horizontal Point Offset (XML)	M [^]	
14/ASEG/VPO:X	[14.025-D:X]	Vertical Point Offset (XML)	M [^]	
14/DMM	[14.030]	Device Monitoring Mode	O	
14/FAP	[14.031]	Subject Acquisition Profile - Fingerprint	O	
14/FCT	[14.901]	Friction Ridge Capture Technology	O	
14/DATA	[14.999]	Fingerprint Image	D	This field is mandatory in all cases, except for when 14/AMP="UP". When 14/AMP="UP", the field is optional.

M=Mandatory, O=Optional, M[^]=Mandatory Info Item within a Field, O[^]=Optional Info Item within a Field, D=Dependent on other Fields/Info Items

14. Palmprint Image Record (aka Type 15)

This chapter describes all the fields that are used in the Palmprint Image Record.

14.1. Package Palmprint Image Record (XML)

Field Reference: 15	Field ID: [15]
Content Type: Set_X	Condition: Optional
XML Tag Name: PackagePalmprintImageRecord	Defined in: xsd/itl/2011/ITL-2007f-Package.xsd
Data Type:	Special Characters: <i>n/a</i>
Minimum Length:	Maximum Length:
Minimum Occurrences: 0	Maximum Occurrences: *
Value range: <i>n/a</i>	Regular Expression: <i>n/a</i>
Code table: <i>n/a</i>	
Base type: itl:PackagePalmprintImageRecordType	Namespace: http://biometrics.nist.gov/standard/2011

XPath

/itl:PackagePalmprintImageRecord

Summary

Contains and is used to exchange palm print image data together with fixed and user-defined textual information fields pertinent to the digitized image.

14. Palmprint Image Record (aka Type 15)

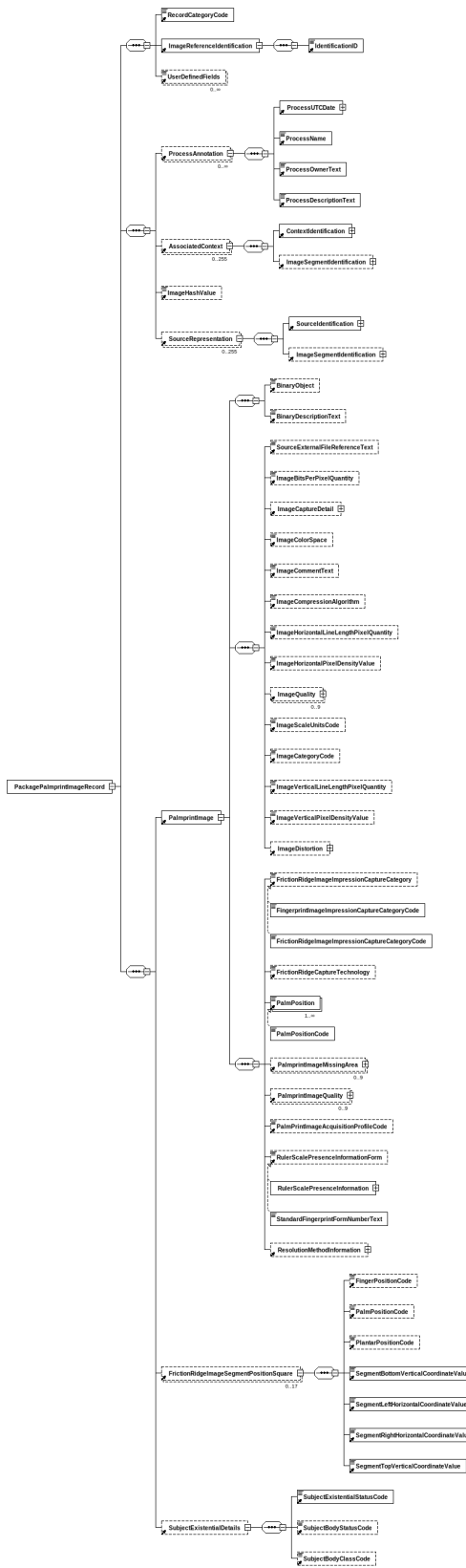

14.2. XML Record Category Code - XRCC

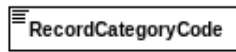

Field Reference: 15/XRCC:X

Content Type: Data_X

XML Tag Name: RecordCategoryCode

Data Type: N

Minimum Length: 1

Minimum Occurrences: 1

Value range: {15}

Code table: *n/a*

Base type: biom:RecordCategoryCodeType

Field ID: [15.001:X]

Condition: Mandatory

Defined in: xsd/niem/biometrics/1.0/biometrics.xsd

Special Characters: *n/a*

Maximum Length: 2

Maximum Occurrences: 1

Regular Expression: *n/a*

Namespace: <http://niem.gov/niem/biometrics/1.0>

XPath

```
/it1:PackagePalmprintImageRecord  
  ↘/biom:RecordCategoryCode
```

Summary

Numeric representation of Record Type.

Valid Examples

```
<biom:RecordCategoryCode>15</biom:RecordCategoryCode>
```

14.3. Information Designation Character - IDC

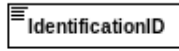

Field Reference: 15/IDC

Content Type: Data

XML Tag Name: IdentificationID

Data Type: N

Minimum Length: 1

Minimum Occurrences: 1

Value range: {0..99}

Code table: *n/a*

Base type: niem-xsd:string

Field ID: [15.002]

Condition: Mandatory

Defined in: xsd/niem/niem-core/2.0/niem-core.xsd

Special Characters: *n/a*

Maximum Length: 2

Maximum Occurrences: 1

Regular Expression: *n/a*

Namespace: <http://niem.gov/niem/niem-core/2.0>

XPath

```
/itl:PackagePalmprintImageRecord  
  ↙/biom:ImageReferenceIdentification  
    ↙/nc:IdentificationID
```

Summary

IDC assigned to this Type-15 record as listed in 1.003.

Valid Examples

```
<nc:IdentificationID>8</nc:IdentificationID>
```

14.4. Palmprint Image (XML)

Field Reference: 15/IMP_15/DATA
Content Type: Set_X
XML Tag Name: PalmprintImage
Data Type:
Minimum Length:
Minimum Occurrences: 1
Value range: *n/a*
Code table: *n/a*
Base type: biom:PalmprintImageType

Field ID: [15.003_15.999]
Condition: Mandatory
Defined in: xsd/niem/biometrics/1.0/biometrics.xsd
Special Characters: *n/a*
Maximum Length:
Maximum Occurrences: 1
Regular Expression: *n/a*
Namespace: <http://niem.gov/niem/biometrics/1.0>

XPath

```
/it1:PackagePalmprintImageRecord  
  ↘/biom:PalmprintImage
```

Summary

Image and associated information.

Notes

Applies to 15.003, 15.004, 15.005, 15.006, 15.007, 15.008, 15.009, 15.010, 15.011, 15.012, 15.013, 15.018, 15.024, 15.903, 15.016, 15.017, 15.020, 15.030, 15.904, 15.993, 15.998 and 15.999

14. Palmprint Image Record (aka Type 15)

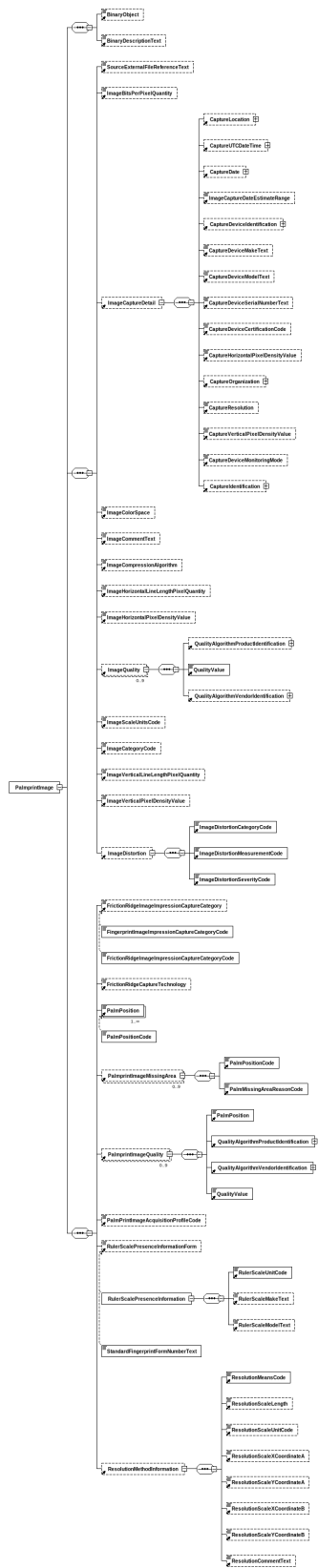

14.5. Impression Type - IMP

 FingerprintImageImpressionCaptureCategoryCode
--

Field Reference: 15/IMP

Content Type: Data

XML Tag Name: FingerprintImageImpressionCaptureCategoryCode

Data Type: N

Minimum Length: 2

Minimum Occurrences: 1

Value range: {0,8,24,25,28,29,41,42}

Code table: see table [A.31](#)

Base type: biom:ImpressionCaptureCategoryCodeType

Field ID: [15.003]

Condition: Mandatory

Defined in: xsd/niem/biometrics/1.0/biometrics.xsd

Special Characters: *n/a*

Maximum Length: 2

Maximum Occurrences: 1

Regular Expression: *n/a*

Namespace: <http://niem.gov/niem/biometrics/1.0>

XPath

```
/it1:PackagePalmprintImageRecord
  ↳/biom:PalmpointImage
    ↳/biom:FingerprintImageImpressionCaptureCategoryCode
```

Summary

Manner by which palm print was obtained.

Valid Examples

<pre><biom:FingerprintImageImpressionCaptureCategoryCode>10</biom:FingerprintImageImpressionCaptureCategoryCode></pre>
--

14.6. Capture Organization (XML)

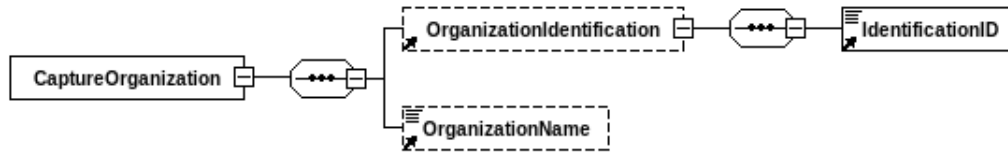

Field Reference: 15/SRC_15/SAN
Content Type: Set_X
XML Tag Name: CaptureOrganization
Data Type:
Minimum Length:
Minimum Occurrences: 1
Value range: *n/a*
Code table: *n/a*
Base type: nc:OrganizationType

Field ID: [15.004_15.993]
Condition: Mandatory
Defined in: xsd/niem/biometrics/1.0/biometrics.xsd
Special Characters: *n/a*
Maximum Length:
Maximum Occurrences: 1
Regular Expression: *n/a*
Namespace: <http://niem.gov/niem/biometrics/1.0>

XPath

```

/itl:PackagePalmprintImageRecord
  ↳/biom:PalmpointImage
    ↳/biom:ImageCaptureDetail
      ↳/biom:CaptureOrganization
  
```

Summary

Identifier of agency that created record and supplied information contained in it.

Notes

Applies to 15.004 and 15.993

14.7. Source Agency - SRC

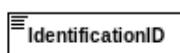

Field Reference: 15/SRC

Content Type: Data

XML Tag Name: IdentificationID

Data Type: U

Minimum Length: 1

Minimum Occurrences: 1

Value range: *n/a*

Code table: *n/a*

Base type: niem-xsd:string

Field ID: [15.004]

Condition: Mandatory

Defined in: xsd/niem/niem-core/2.0/niem-core.xsd

Special Characters: *n/a*

Maximum Length: *

Maximum Occurrences: 1

Regular Expression: *n/a*

Namespace: <http://niem.gov/niem/niem-core/2.0>

XPath

```
/it1:PackagePalmprintImageRecord
  ↳/biom:PalprintImage
    ↳/biom:ImageCaptureDetail
      ↳/biom:CaptureOrganization
        ↳/nc:OrganizationIdentification
          ↳/nc:IdentificationID
```

Summary

Identifier of agency that created and supplied information contained in the record. The source agency name may be entered in 15.993.

Valid Examples

```
<nc:IdentificationID>WI013415Y</nc:IdentificationID>
```

14.8. Palmprint Capture Date (XML) - PCD



Field Reference: 15/PCD:X
Content Type: Data_X
XML Tag Name: Date
Data Type: NS
Minimum Length: 10
Minimum Occurrences: 1
Value range: *n/a*
Code table: *n/a*
Base type: [niem-xsd:date](#)

Field ID: [15.005:X]
Condition: Mandatory
Defined in: [xsd/niem/niem-core/2.0/niem-core.xsd](#)
Special Characters: [-]
Maximum Length: 10
Maximum Occurrences: 1
Regular Expression: \d{4}-\d{2}-\d{2}
Namespace: <http://niem.gov/niem/niem-core/2.0>

XPath

```

/itl:PackagePalmprintImageRecord
  ↳/biom:PalmprintImage
    ↳/biom:ImageCaptureDetail
      ↳/biom:CaptureDate
        ↳/nc:Date
  
```

Summary

Palmprint capture date.

Valid Examples

```
<nc:Date>2007-01-01</nc:Date>
```

14.9. Horizontal Line Length - HLL

 ImageHorizontalLineLengthPixelQuantity
--

Field Reference: 15/HLL

Content Type: Data

XML Tag Name: ImageHorizontalLineLengthPixelQuantity

Data Type: N

Minimum Length: 2

Minimum Occurrences: 0

Value range: {10..99999}

Code table: *n/a*

Base type: niem-xsd:integer

Field ID: [15.006]

Condition: Dependent (see table)

Defined in: xsd/niem/biometrics/1.0/biometrics.xsd

Special Characters: *n/a*

Maximum Length: 5

Maximum Occurrences: 1

Regular Expression: *n/a*

Namespace: <http://niem.gov/niem/biometrics/1.0>

Dependency table

Type of dependency	Value
Mandatory on Presence of other Field	15/DATA

XPath

```
/it1:PackagePalmprintImageRecord
└─/biom:PalmpImage
  └─/biom:ImageHorizontalLineLengthPixelQuantity
```

Summary

Number of pixels contained on a single horizontal line of the image.

Valid Examples

```
<biom:ImageHorizontalLineLengthPixelQuantity>80</biom:ImageHorizontalLineLengthPixelQuantity>
```

14.10. Vertical Line Length - VLL

 ImageVerticalLineLengthPixelQuantity
--

Field Reference: 15/VLL**Content Type:** Data**XML Tag Name:** ImageVerticalLineLengthPixelQuantity**Data Type:** N**Minimum Length:** 2**Minimum Occurrences:** 0**Value range:** {10..99999}**Code table:** *n/a***Base type:** niem-xsd:integer**Field ID:** [15.007]**Condition:** Dependent (see table)**Defined in:** xsd/niem/biometrics/1.0/biometrics.xsd**Special Characters:** *n/a***Maximum Length:** 5**Maximum Occurrences:** 1**Regular Expression:** *n/a***Namespace:** <http://niem.gov/niem/biometrics/1.0>

Dependency table

Type of dependency	Value
Mandatory on Presence of other Field	15/DATA

XPath

```
/it1:PackagePalmprintImageRecord
└─/biom:PalmpImage
  └─/biom:ImageVerticalLineLengthPixelQuantity
```

Summary

Number of pixels contained on a single vertical line of the image.

Valid Examples

```
<biom:ImageVerticalLineLengthPixelQuantity>65</biom:ImageVerticalLineLengthPixelQuantity>
```

14.11. Scale Units - SLC

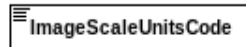

Field Reference: 15/SLC

Content Type: Data

XML Tag Name: ImageScaleUnitsCode

Data Type: N

Minimum Length: 1

Minimum Occurrences: 0

Value range: {1}

Code table: see table [A.59](#)

Base type: biom:ScaleUnitsCodeType

Field ID: [15.008]

Condition: Dependent (see table)

Defined in: xsd/niem/biometrics/1.0/biometrics.xsd

Special Characters: *n/a*

Maximum Length: 1

Maximum Occurrences: 1

Regular Expression: *n/a*

Namespace: <http://niem.gov/niem/biometrics/1.0>

Dependency table

Type of dependency	Value
Mandatory on Presence of other Field	15/DATA

XPath

```
/it1:PackagePalmprintImageRecord
  ↙/biom:PalmprintImage
    ↙/biom:ImageScaleUnitsCode
```

Summary

Image sampling frequency (pixel density).

Notes

Only code 1 (ppi) is allowed in INTERPOL's implementation.

Valid Examples

```
<biom:ImageScaleUnitsCode>1</biom:ImageScaleUnitsCode>
```

14.12. Transmitted Horizontal Pixel Scale - THPS

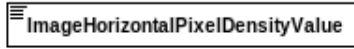

Field Reference: 15/THPS

Content Type: Data

XML Tag Name: ImageHorizontalPixelDensityValue

Data Type: N

Minimum Length: 1

Minimum Occurrences: 0

Value range: {1000,500}

Code table: *n/a*

Base type: niem-xsd:nonNegativeInteger

Field ID: [15.009]

Condition: Dependent (see table)

Defined in: xsd/niem/biometrics/1.0/biometrics.xsd

Special Characters: *n/a*

Maximum Length: 5

Maximum Occurrences: 1

Regular Expression: *n/a*

Namespace: <http://niem.gov/niem/biometrics/1.0>

Dependency table

Type of dependency	Value
Mandatory on Presence of other Field	15/DATA

XPath

```
/it1:PackagePalmprintImageRecord
  ↳/biom:PalmpImage
    ↳/biom:ImageHorizontalPixelDensityValue
```

Summary

Integer pixel density in the horizontal direction (if 15/SLC = 1 or 2); otherwise, if 15/SLC = 0, the horizontal component of the pixel aspect ratio.

Notes

For example, if the SLC value = 1, then the value of THPS could be '1000' for a 1000 ppi sensor.

Technical Notes

If 15/SLC=1,2, then THPS shall equal TVPS.

Valid Examples

```
<biom:ImageHorizontalPixelDensityValue>1000</biom:ImageHorizontalPixelDensityValue>
```

14.13. Transmitted Vertical Pixel Scale - TVPS

 ImageVerticalPixelDensityValue
--

Field Reference: 15/TVPS

Content Type: Data

XML Tag Name: ImageVerticalPixelDensityValue

Data Type: N

Minimum Length: 1

Minimum Occurrences: 0

Value range: {1000,500}

Code table: *n/a*

Base type: niem-xsd:nonNegativeInteger

Field ID: [15.010]

Condition: Dependent (see table)

Defined in: xsd/niem/biometrics/1.0/biometrics.xsd

Special Characters: *n/a*

Maximum Length: 5

Maximum Occurrences: 1

Regular Expression: *n/a*

Namespace: <http://niem.gov/niem/biometrics/1.0>

Dependency table

Type of dependency	Value
Mandatory on Presence of other Field	15/DATA

XPath

```
/it1:PackagePalmprintImageRecord
  ↙/biom:PalmpImage
    ↙/biom:ImageVerticalPixelDensityValue
```

Summary

Integer pixel density in the vertical direction (if 15/SLC = 1 or 2); otherwise, if 15/SLC = 0, the vertical component of the pixel aspect ratio.

Technical Notes

If 15/SLC=1,2, then THPS shall equal TVPS.

Valid Examples

```
<biom:ImageVerticalPixelDensityValue>1000</biom:ImageVerticalPixelDensityValue>
```

14.14. Compression Algorithm - CGA

 ImageCompressionAlgorithmText
--

Field Reference: 15/CGA

Content Type: Data

XML Tag Name: ImageCompressionAlgorithmText

Data Type: AN

Minimum Length: 3

Minimum Occurrences: 0

Value range: {"JP2","JP2L","WSQ20"}

Code table: see table [A.6](#)

Base type: nc:TextType

Field ID: [15.011]

Condition: Dependent (see table)

Defined in: xsd/niem/biometrics/1.0/biometrics.xsd

Special Characters: *n/a*

Maximum Length: 5

Maximum Occurrences: 1

Regular Expression: *n/a*

Namespace: <http://niem.gov/niem/biometrics/1.0>

Dependency table

Type of dependency	Value
Mandatory on Presence of other Field	15/DATA

XPath

```
/it1:PackagePalmprintImageRecord
└─/biom:PalmpointImage
  └─/biom:ImageCompressionAlgorithmText
```

Summary

Algorithm used to compress the transmitted grayscale images.

Notes

INTERPOL standard restricts the possible formats to the following ones, depending on the image resolution:

500ppi images WSQ

1000ppi images JPEG 2000 lossless, or JPEG 2000 lossy, with a compression ratio of 10:1

Valid Examples

```
<biom:ImageCompressionAlgorithmText>WSQ20</biom:ImageCompressionAlgorithmText>
```

14.15. Bits Per Pixel - BPX

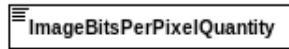

Field Reference: 15/BPX

Content Type: Data

XML Tag Name: ImageBitsPerPixelQuantity

Data Type: N

Minimum Length: 1

Minimum Occurrences: 0

Value range: {8}

Code table: *n/a*

Base type: niem-xsd:nonNegativeInteger

Field ID: [15.012]

Condition: Dependent (see table)

Defined in: xsd/niem/biometrics/1.0/biometrics.xsd

Special Characters: *n/a*

Maximum Length: 2

Maximum Occurrences: 1

Regular Expression: *n/a*

Namespace: <http://niem.gov/niem/biometrics/1.0>

Dependency table

Type of dependency	Value
Mandatory on Presence of other Field	15/DATA

XPath

```
/it1:PackagePalmprintImageRecord
  ↳/biom:PalmpImage
    ↳/biom:ImageBitsPerPixelQuantity
```

Summary

Number of bits per pixel.

Notes

This field shall contain an entry of "8" for normal grayscale values of "0" to "255". Any entry in this field greater than "8" shall be used to represent a grayscale pixel with increased proportion. For color, BPX represents the total number of bits per pixel (not per color). For instance, BPX=24 represents a 24-bit RGB image using 8 bits for each color.

INTERPOL's implementation only supports 8-bit grayscale images.

Valid Examples

```
<biom:ImageBitsPerPixelQuantity>8</biom:ImageBitsPerPixelQuantity>
```

14.16. Friction Ridge Generalized Position - FGP

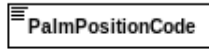

Field Reference: 15/FGP

Content Type: Data

XML Tag Name: PalmPositionCode

Data Type: N

Minimum Length: 2

Minimum Occurrences: 1

Value range: {21..28}

Code table: see table [A.25](#)

Base type: biom:PalmPositionCodeType

Field ID: [15.013]

Condition: Mandatory

Defined in: xsd/niem/biometrics/1.0/biometrics.xsd

Special Characters: *n/a*

Maximum Length: 2

Maximum Occurrences: 1

Regular Expression: *n/a*

Namespace: <http://niem.gov/niem/biometrics/1.0>

XPath

```
/it1:PackagePalmprintImageRecord
  ↙/biom:PalmprintImage
    ↙/biom:PalmPositionCode
```

Summary

Palm print position.

Notes

INTERPOL's implementation only allows FGP between 21 and 28.

Valid Examples

```
<biom:PalmPositionCode>21</biom:PalmPositionCode>
```

14.17. Amputated or Bandaged - AMP

Field Reference: 15/AMP	Field ID: [15.018]
Content Type: Set	Condition: Optional
XML Tag Name: PalmprintImageMissingArea	Defined in: xsd/niem/biometrics/1.0/biometrics.xsd
Data Type:	Special Characters: <i>n/a</i>
Minimum Length:	Maximum Length:
Minimum Occurrences: 0	Maximum Occurrences: 9
Value range: <i>n/a</i>	Regular Expression: <i>n/a</i>
Code table: <i>n/a</i>	
Base type: biom:PalmprintImageMissingAreaType	Namespace: http://niem.gov/niem/biometrics/1.0

XPath

```
/it1:PackagePalmprintImageRecord  
  ↪/biom:PalmprintImage  
    ↪/biom:PalmprintImageMissingArea
```

Summary

Specifies if a hand is amputated or bandaged.

14.18. Friction Ridge Amputated or Bandaged Position - FRAP

 PalmPositionCode

Field Reference: 15/AMP/FRAP

Content Type: Data

XML Tag Name: PalmPositionCode

Data Type: N

Minimum Length: 1

Minimum Occurrences: 1

Value range: {21..28}

Code table: see table [A.25](#)

Base type: biom:PalmPositionCodeType

Field ID: [15.018-A]

Condition: Mandatory within a field

Defined in: xsd/niem/biometrics/1.0/biometrics.xsd

Special Characters: *n/a*

Maximum Length: 2

Maximum Occurrences: 1

Regular Expression: *n/a*

Namespace: <http://niem.gov/niem/biometrics/1.0>

XPath

```
/it1:PackagePalmprintImageRecord
  ↙/biom:PalmprintImage
    ↙/biom:PalmprintImageMissingArea
      ↙/biom:PalmPositionCode
```

Summary

Friction ridge amputated or bandaged position.

Notes

INTERPOL's implementation only allows FGP between 21 and 28.

Valid Examples

```
<biom:PalmPositionCode>20</biom:PalmPositionCode>
```

14.19. Amputated or Bandaged Code - ABC

Field Reference: 15/AMP/ABC	Field ID: [15.018-B]
Content Type: Data	Condition: Mandatory within a field
XML Tag Name: PalmMissingAreaReasonCode	Defined in: xsd/niem/biometrics/1.0/biometrics.xsd
Data Type: A	Special Characters: <i>n/a</i>
Minimum Length: 2	Maximum Length: 2
Minimum Occurrences: 1	Maximum Occurrences: 1
Value range: {"XX","UP"}	Regular Expression: <i>n/a</i>
Code table: see table A.1	
Base type: biom:FrictionRidgeImageMissingAreaReasonCodeType Namespace: http://niem.gov/niem/biometrics/1.0	

XPath

```
/itl:PackagePalmprintImageRecord
  ↙/biom:PalmprintImage
    ↙/biom:PalmprintImageMissingArea
      ↙/biom:PalmMissingAreaReasonCode
```

Summary

Amputated or bandaged code.

Notes

XX shall be used only when a partial print exists due to amputation; therefore it contains some friction ridge detail. (The palm is not totally amputated, some countries might qualify such print as "mutilated")

UP shall be used with the complete block where an image was to be transmitted, but there is no image due to amputation or total lack of friction ridge detail (such as with a bandage).

An image with a scar should not be marked XX or UP, the 14.018 field should not be present. The SR (scar) code of the ANSI-NIST standard should not be used in INTERPOL's implementation.

Note that if a palm has simply not been acquired (for instance in the case of a 2-finger acquisition), no type 15 should be created for this palm.

Valid Examples

```
<biom:PalmMissingAreaReasonCode>UP</biom:PalmMissingAreaReasonCode>
```

14.20. Palm Segment Position - SEG

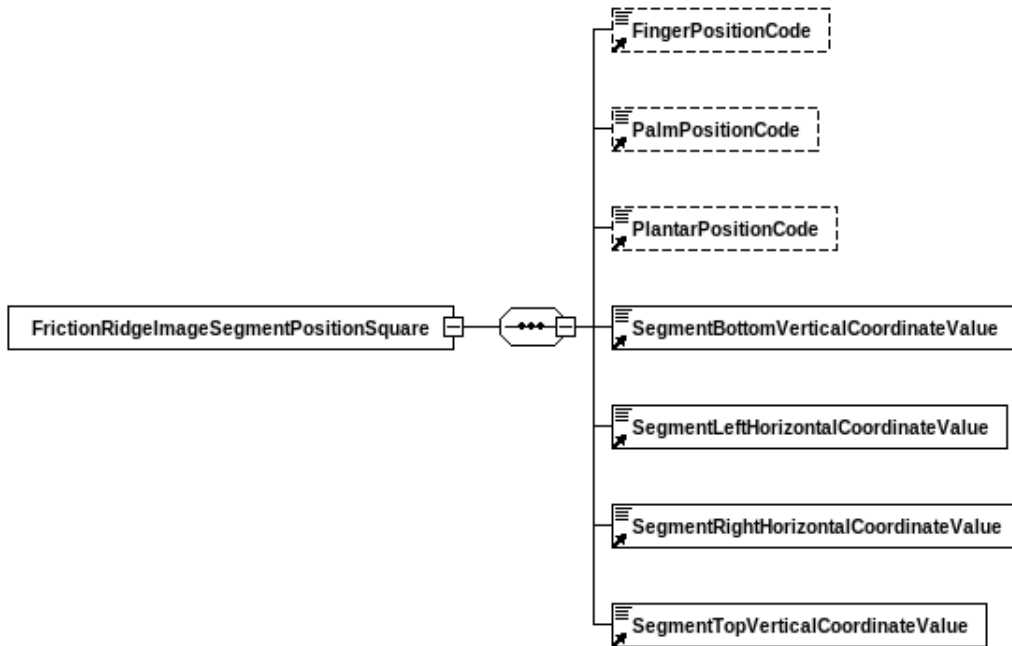

Field Reference: 15/SEG

Content Type: Set

XML Tag Name: FrictionRidgeImageSegmentPositionSquare

Data Type:

Minimum Length:

Minimum Occurrences: 0

Value range: *n/a*

Code table: *n/a*

Base type: biom:FrictionRidgeImageSegmentPositionSquareType

Field ID: [15.021]

Condition: Dependent (see table)

Defined in: xsd/niem/biometrics/1.0/biometrics.xsd

Special Characters: *n/a*

Maximum Length:

Maximum Occurrences: 17

Regular Expression: *n/a*

Namespace: <http://niem.gov/niem/biometrics/1.0>

Dependency table

Type of dependency	Value
Optional on Value of other Field, should not be set otherwise.	[15/FGP]IN{20,21,23}

XPath

```
/it1:PackagePalmprintImageRecord
  ↘/biom:FrictionRidgeImageSegmentPositionSquare
```

Summary

Offsets to the locations of palm image segments.

Notes

If the segmentation information are present, it is up to the receiving system to decide whether or not it will be used. There is hence no guaranty that the receiving system will use the same segmentation as the emitting one.

Valid Examples

```
<biom:FrictionRidgeImageSegmentPositionSquare>  
  <biom:PalmPositionCode>23</biom:PalmPositionCode>  
  <biom:SegmentLeftHorizontalCoordinateValue>48255</biom:SegmentLeftHorizontalCoordinateValue>  
  <biom:SegmentRightHorizontalCoordinateValue>49244</biom:SegmentRightHorizontalCoordinateValue>  
  <biom:SegmentTopVerticalCoordinateValue>48255</biom:SegmentTopVerticalCoordinateValue>  
  <biom:SegmentBottomVerticalCoordinateValue>49244</biom:SegmentBottomVerticalCoordinateValue>  
</biom:FrictionRidgeImageSegmentPositionSquare>
```

14.21. Friction Ridge Segment Position - FRSP

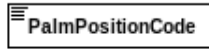

Field Reference: 15/SEG/FRSP

Content Type: Data

XML Tag Name: PalmPositionCode

Data Type: N

Minimum Length: 1

Minimum Occurrences: 1

Value range: {25..28}

Code table: see table [A.25](#) and table [A.26](#)

Base type: biom:PalmPositionCodeType

Field ID: [15.021-A]

Condition: Mandatory within a field

Defined in: xsd/niem/biometrics/1.0/biometrics.xsd

Special Characters: *n/a*

Maximum Length: 2

Maximum Occurrences: 1

Regular Expression: *n/a*

Namespace: <http://niem.gov/niem/biometrics/1.0>

XPath

```
/it1:PackagePalmprintImageRecord  
  ↙/biom:FrictionRidgeImageSegmentPositionSquare  
    ↙/biom:PalmPositionCode
```

Summary

Friction ridge segment position.

Valid Examples

```
<biom:PalmPositionCode>23</biom:PalmPositionCode>
```

14.22. Left Horizontal Coordinate Value - LHC

 SegmentLeftHorizontalCoordinateValue
--

Field Reference: 15/SEG/LHC

Content Type: Data

XML Tag Name: SegmentLeftHorizontalCoordinateValue

Data Type: N

Minimum Length: 1

Minimum Occurrences: 1

Value range: *n/a*

Code table: *n/a*

Base type: niem-xsd:nonNegativeInteger

Field ID: [15.021-B]

Condition: Mandatory within a field

Defined in: xsd/niem/biometrics/1.0/biometrics.xsd

Special Characters: *n/a*

Maximum Length: 5

Maximum Occurrences: 1

Regular Expression: *n/a*

Namespace: <http://niem.gov/niem/biometrics/1.0>

XPath

```
/it1:PackagePalmprintImageRecord  
  ↳/biom:FrictionRidgeImageSegmentPositionSquare  
    ↳/biom:SegmentLeftHorizontalCoordinateValue
```

Summary

Horizontal offset in pixels to the left edge of the bounding box relative to the origin positioned in the upper left corner of the image.

Valid Examples

<code><biom:SegmentLeftHorizontalCoordinateValue>48255</biom:SegmentLeftHorizontalCoordinateValue></code>

14.23. Right Horizontal Coordinate Value - RHC

SegmentRightHorizontalCoordinateValue

Field Reference: 15/SEG/RHC**Content Type:** Data**XML Tag Name:** SegmentRightHorizontalCoordinateValue**Data Type:** N**Minimum Length:** 1**Minimum Occurrences:** 1**Value range:** *n/a***Code table:** *n/a***Base type:** niem-xsd:nonNegativeInteger**Field ID:** [15.021-C]**Condition:** Mandatory within a field**Defined in:** xsd/niem/biometrics/1.0/biometrics.xsd**Special Characters:** *n/a***Maximum Length:** 5**Maximum Occurrences:** 1**Regular Expression:** *n/a***Namespace:** <http://niem.gov/niem/biometrics/1.0>**XPath**

```
/it1:PackagePalmprintImageRecord
  ↙/biom:FrictionRidgeImageSegmentPositionSquare
    ↙/biom:SegmentRightHorizontalCoordinateValue
```

Summary

Horizontal offset in pixels to the right edge of the bounding box relative to the origin positioned in the upper left corner of the image.

Valid Examples

```
<biom:SegmentRightHorizontalCoordinateValue>49244</biom:SegmentRightHorizontalCoordinateValue>
```

14.24. Top Vertical Coordinate Value - TVC

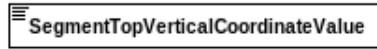

Field Reference: 15/SEG/TVC

Content Type: Data

XML Tag Name: SegmentTopVerticalCoordinateValue

Data Type: N

Minimum Length: 1

Minimum Occurrences: 1

Value range: *n/a*

Code table: *n/a*

Base type: niem-xsd:nonNegativeInteger

Field ID: [15.021-D]

Condition: Mandatory within a field

Defined in: xsd/niem/biometrics/1.0/biometrics.xsd

Special Characters: *n/a*

Maximum Length: 5

Maximum Occurrences: 1

Regular Expression: *n/a*

Namespace: <http://niem.gov/niem/biometrics/1.0>

XPath

```
/it1:PackagePalmprintImageRecord  
  ↳/biom:FrictionRidgeImageSegmentPositionSquare  
    ↳/biom:SegmentTopVerticalCoordinateValue
```

Summary

Vertical offset (pixel counts down) to the top of the bounding box.

Valid Examples

```
<biom:SegmentTopVerticalCoordinateValue>48255</biom:SegmentTopVerticalCoordinateValue>
```

14.25. Bottom Vertical Coordinate Value - BVC

SegmentBottomVerticalCoordinateValue

Field Reference: 15/SEG/BVC

Content Type: Data

XML Tag Name: SegmentBottomVerticalCoordinateValue

Data Type: N

Minimum Length: 1

Minimum Occurrences: 1

Value range: *n/a*

Code table: *n/a*

Base type: niem-xsd:nonNegativeInteger

Field ID: [15.021-E]

Condition: Mandatory within a field

Defined in: xsd/niem/biometrics/1.0/biometrics.xsd

Special Characters: *n/a*

Maximum Length: 5

Maximum Occurrences: 1

Regular Expression: *n/a*

Namespace: <http://niem.gov/niem/biometrics/1.0>

XPath

```
/it1:PackagePalmprintImageRecord  
  ↳/biom:FrictionRidgeImageSegmentPositionSquare  
    ↳/biom:SegmentBottomVerticalCoordinateValue
```

Summary

Vertical offset (in pixels) from the upper left corner of the image down to the bottom of the bounding box.

Valid Examples

```
<biom:SegmentBottomVerticalCoordinateValue>49244</biom:SegmentBottomVerticalCoordinateValue>
```

14.26. Subject Acquisition Profile – Palmprint - PAP

Field Reference: 15/PAP	Field ID: [15.031]
Content Type: Data	Condition: Optional
XML Tag Name: PalmprintImageAcquisitionProfileCode	Defined in: xsd/niem/biometrics/1.0/biometrics.xsd
Data Type: N	Special Characters: <i>n/a</i>
Minimum Length: 2	Maximum Length: 2
Minimum Occurrences: 0	Maximum Occurrences: 1
Value range: <i>n/a</i>	Regular Expression: <i>n/a</i>
Code table: see table A.41	
Base type: biom:PalmprintImageAcquisitionProfileCodeType	Namespace: http://niem.gov/niem/biometrics/1.0

XPath

```
/it1:PackagePalmprintImageRecord  
  ↪/biom:PalmprintImpressionImage  
    ↪/biom:PalmprintImageAcquisitionProfileCode
```

Summary

PAP level associated with the palmprint acquisition device.

Valid Examples

```
<biom:PalmprintImageAcquisitionProfileCode>70</biom:PalmprintImageAcquisitionProfileCode>
```

14.27. Friction Ridge Capture Technology - FCT

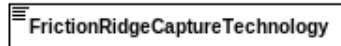

Field Reference: 15/FCT	Field ID: [15.901]
Content Type: Data_X	Condition: Optional
XML Tag Name: FrictionRidgeCaptureTechnology	Defined in: xsd/niem/biometrics/1.0/biometrics.xsd
Data Type: N	Special Characters: <i>n/a</i>
Minimum Length: 1	Maximum Length: 2
Minimum Occurrences: 0	Maximum Occurrences: 1
Value range: {0..7,9..17}	Regular Expression: <i>n/a</i>
Code table: see table A.24	
Base type: biom:FrictionRidgeCaptureTechnologyType	Namespace: http://niem.gov/niem/biometrics/1.0

XPath

```
/it1:PackagePalmprintImageRecord
  ↙/biom:PalmpointImpressionImage
    ↙/
      ↙/biom:FrictionRidgeCaptureTechnology
```

Summary

The technology used to capture friction ridge data

Valid Examples

```
<biom:FrictionRidgeCaptureTechnology>0</biom:FrictionRidgeCaptureTechnology>
```

14.28. Palmprint Image - DATA

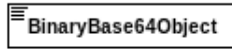

Field Reference: 15/DATA

Content Type: Data

XML Tag Name: BinaryBase64Object

Data Type: B

Minimum Length: 1

Minimum Occurrences: 0

Value range: *n/a*

Code table: *n/a*

Base type: niem-xsd:base64Binary

Field ID: [15.999]

Condition: Dependent (see table)

Defined in: xsd/niem/niem-core/2.0/niem-core.xsd

Special Characters: *n/a*

Maximum Length: *

Maximum Occurrences: 1

Regular Expression: *n/a*

Namespace: <http://niem.gov/niem/niem-core/2.0>

Dependency table

Type of dependency	Value
Other Dependency	Field is mandatory for all cases, except when 15.018/AMP="UP" (then is optional).

XPath

```
/it1:PackagePalmprintImageRecord
  ↙/biom:PalmpintImage
    ↙/nc:BinaryBase64Object
```

Summary

Palmpint image.

Notes

Binary for Traditional encoding or Base64 for XML

Technical Notes

Field is mandatory for all cases, except when 15.018/AMP="UP" (then is optional).

Valid Examples

```
<nc:BinaryBase64Object>mrHbPdrko3u1s7ahtgPBjtm01s85tfG2U7bpofY94Czu2SbY7d7wF9fQ7ZptgGrtk02a2dsJ7wZbe8BlzvAmQ7xq+
Y94GoHeEsR3ikWd4DIGhzmp3k42d4DRmzs94DKveDTB3hqw6PeBLrtpPep0H/+h</nc:BinaryBase64Object>
```

14.29. Field Mandatoriness in Palmprint Image Record

The following table shows a summary of the fields and information items in each record type and its corresponding XML elements, and in particular the fields and items that are mandatory.

Table 14.1.: Field Summary for Type 15 Records

Field Id	Code	Field Name	Card.	Notes
15/XRCC:X	[15.001:X]	XML Record Category Code	M	
15/IDC	[15.002]	Information Designation Character	M	
15/IMP_15/DATA	[15.003_15.999]	Palmprint Image (XML)	M	
15/IMP	[15.003]	Impression Type	M	
15/SRC_15/SAN	[15.004_15.993]	Capture Organization (XML)	M	
15/SRC	[15.004]	Source Agency	M	
15/PCD:X	[15.005:X]	Palmprint Capture Date (XML)	M	
15/HLL	[15.006]	Horizontal Line Length	D	This field is required (and not permitted otherwise) if 15/DATA is/are present.
15/VLL	[15.007]	Vertical Line Length	D	This field is required (and not permitted otherwise) if 15/DATA is/are present.
15/SLC	[15.008]	Scale Units	D	This field is required (and not permitted otherwise) if 15/DATA is/are present.
15/THPS	[15.009]	Transmitted Horizontal Pixel Scale	D	This field is required (and not permitted otherwise) if 15/DATA is/are present.
15/TVPS	[15.010]	Transmitted Vertical Pixel Scale	D	This field is required (and not permitted otherwise) if 15/DATA is/are present.
15/CGA	[15.011]	Compression Algorithm	D	This field is required (and not permitted otherwise) if 15/DATA is/are present.
15/BPX	[15.012]	Bits Per Pixel	D	This field is required (and not permitted otherwise) if 15/DATA is/are present.
15/FGP	[15.013]	Friction Ridge Generalized Position	M	
15/AMP	[15.018]	Amputated or Bandaged	O	
15/AMP/FRAP	[15.018-A]	Friction Ridge Amputated or Bandaged Position	M [^]	
15/AMP/ABC	[15.018-B]	Amputated or Bandaged Code	M [^]	
15/SEG	[15.021]	Palm Segment Position	D	This field is optional (and should not be entered otherwise) if [15/FGP]IN20,21,23
15/SEG/FRSP	[15.021-A]	Friction Ridge Segment Position	M [^]	
15/SEG/LHC	[15.021-B]	Left Horizontal Coordinate Value	M [^]	
15/SEG/RHC	[15.021-C]	Right Horizontal Coordinate Value	M [^]	
15/SEG/TVC	[15.021-D]	Top Vertical Coordinate Value	M [^]	
15/SEG/BVC	[15.021-E]	Bottom Vertical Coordinate Value	M [^]	
15/PAP	[15.031]	Subject Acquisition Profile – Palmprint	O	
15/FCT	[15.901]	Friction Ridge Capture Technology	O	
15/DATA	[15.999]	Palmprint Image	D	Field is mandatory for all cases, except when 15.018/AMP="UP" (then is optional).

M=Mandatory, O=Optional, M[^]=Mandatory Info Item within a Field, O[^]=Optional Info Item within a Field, D=Dependent on other Fields/Info Items

15. Source Representation Record (aka Type 20)

This chapter describes all the fields that are used in the Source Representation Record.

15.1. Package Source Representation Record (XML)

Field Reference: 20	Field ID: [20]
Content Type: Set_X	Condition: Optional
XML Tag Name: PackageSourceRepresentationRecord	Defined in: xsd/itl/2011/ITL-2007f-Package.xsd
Data Type:	Special Characters: <i>n/a</i>
Minimum Length:	Maximum Length:
Minimum Occurrences: 0	Maximum Occurrences: *
Value range: <i>n/a</i>	Regular Expression: <i>n/a</i>
Code table: <i>n/a</i>	
Base type: itl:PackageSourceRepresentationRecordType	Namespace: http://biometrics.nist.gov/standard/2011

XPath

/itl:PackageSourceRepresentationRecord

Summary

Source representation(s) from which other Record Types were derived.

15. Source Representation Record (aka Type 20)

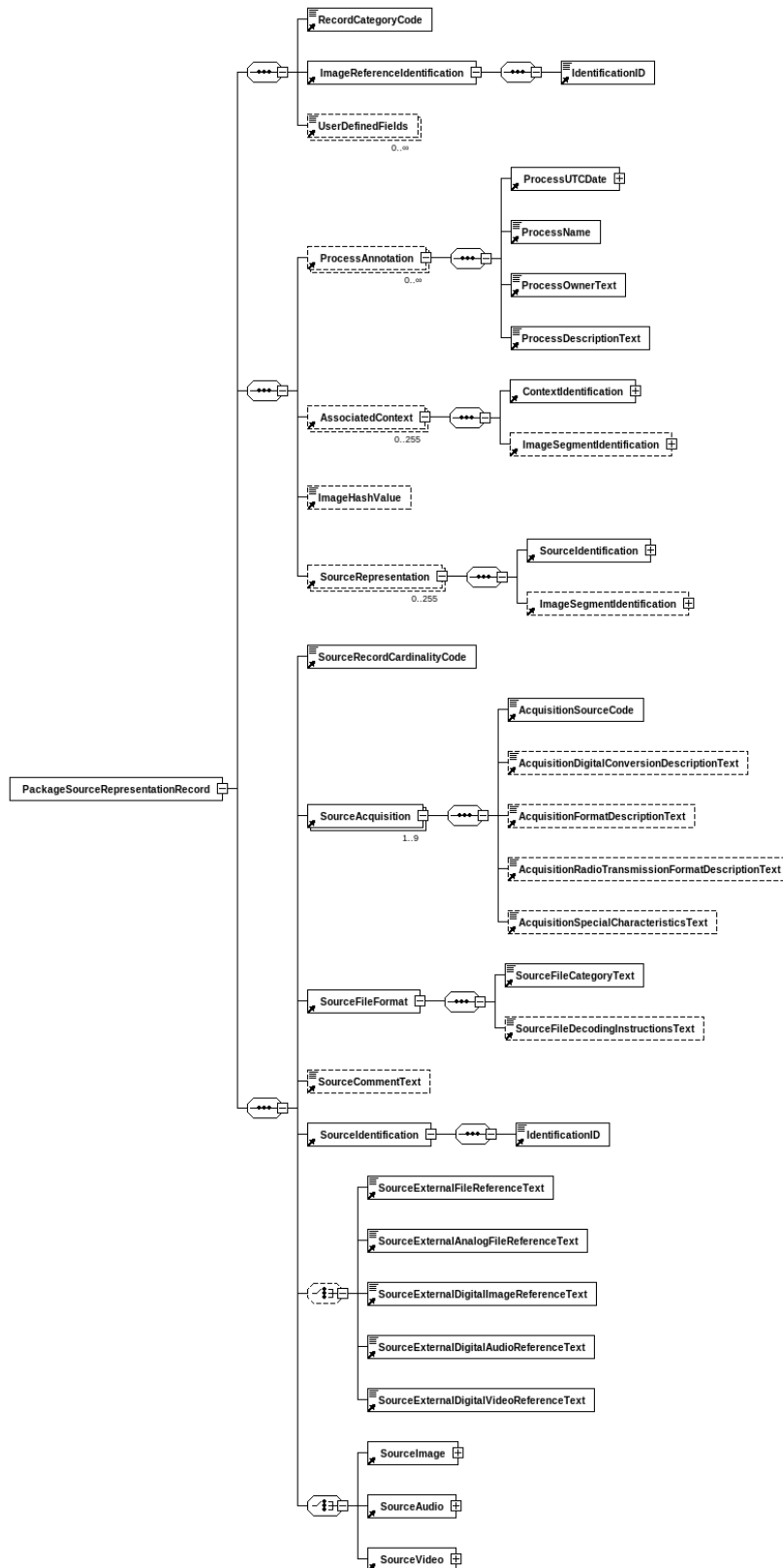

15.2. XML Record Category Code - XRCC

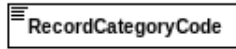

Field Reference: 20/XRCC:X
Content Type: Data_X
XML Tag Name: RecordCategoryCode
Data Type: N
Minimum Length: 1
Minimum Occurrences: 1
Value range: {20}
Code table: *n/a*
Base type: biom:RecordCategoryCodeType

Field ID: [20.001:X]
Condition: Mandatory
Defined in: xsd/niem/biometrics/1.0/biometrics.xsd
Special Characters: *n/a*
Maximum Length: 2
Maximum Occurrences: 1
Regular Expression: *n/a*
Namespace: <http://niem.gov/niem/biometrics/1.0>

XPath

```
/it1:PackageSourceRepresentationRecord  
  ↘/biom:RecordCategoryCode
```

Summary

Numeric representation of Record Type.

Valid Examples

```
<biom:RecordCategoryCode>20</biom:RecordCategoryCode>
```

15.3. Information Designation Character - IDC

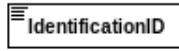

Field Reference: 20/IDC

Content Type: Data

XML Tag Name: IdentificationID

Data Type: N

Minimum Length: 1

Minimum Occurrences: 1

Value range: {0..99}

Code table: *n/a*

Base type: niem-xsd:string

Field ID: [20.002]

Condition: Mandatory

Defined in: xsd/niem/niem-core/2.0/niem-core.xsd

Special Characters: *n/a*

Maximum Length: 2

Maximum Occurrences: 1

Regular Expression: *n/a*

Namespace: <http://niem.gov/niem/niem-core/2.0>

XPath

```
/it1:PackageSourceRepresentationRecord  
  ↙/biom:ImageReferenceIdentification  
    ↙/nc:IdentificationID
```

Summary

IDC assigned to this Type-20 record as listed in 1.003.

Valid Examples

```
<nc:IdentificationID>10</nc:IdentificationID>
```

15.4. SRN Cardinality - CAR

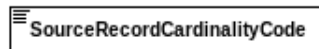

Field Reference: 20/CAR

Content Type: Data

XML Tag Name: SourceRecordCardinalityCode

Data Type: A

Minimum Length: 1

Minimum Occurrences: 1

Value range: {"D"}

Code table: see table [A.4](#)

Base type: biom:SourceRecordCardinalityCodeType

Field ID: [20.003]

Condition: Mandatory

Defined in: xsd/niem/biometrics/1.0/biometrics.xsd

Special Characters: *n/a*

Maximum Length: 1

Maximum Occurrences: 1

Regular Expression: *n/a*

Namespace: <http://niem.gov/niem/biometrics/1.0>

XPath

```
/it1:PackageSourceRepresentationRecord
  ↘/biom:SourceRecordCardinalityCode
```

Summary

Indicates how the record is being used. It describes the cardinality: one to one (S), one to many (D), or many-to-one (M) of how the source representation record relates to other record(s) within the transaction.

Notes

Only cardinality "D" is possible in INTERPOL's implementation.

Valid Examples

```
<biom:SourceRecordCardinalityCode>D</biom:SourceRecordCardinalityCode>
```

15.5. Source Type (XML)

Field Reference: 20/SRC_20/DATA	Field ID: [20.004_20.999]
Content Type: Set_X	Condition: Mandatory
XML Tag Name: SourceVideo or SourceAudio or SourceImage	Defined in: xsd/niem/biometrics/1.0/biometrics.xsd
Data Type:	Special Characters: <i>n/a</i>
Minimum Length:	Maximum Length:
Minimum Occurrences: 1	Maximum Occurrences: 1
Value range: <i>n/a</i>	Regular Expression: <i>n/a</i>
Code table: <i>n/a</i>	
Base type: biom:AudioType or biom:SegmentedImageType or biom:VideoType	Namespace: http://niem.gov/niem/biometrics/1.0

XPath

```

if [20/AQS/AQT] IN 1..6, 11 then
/itl:PackageSourceRepresentationRecord
  ↘/biom:SourceImage
elseif [20/AQS/AQT] IN 7..10, 19..21 then
/itl:PackageSourceRepresentationRecord
  ↘/biom:SourceVideo
elseif [20/AQS/AQT] IN 12..18, 22..29 then
/itl:PackageSourceRepresentationRecord
  ↘/biom:SourceAudio
elseif [20/AQS/AQT] IN 0, 30, 31 then
/itl:PackageSourceRepresentationRecord
  ↘/biom:SourceAudio
OR
/itl:PackageSourceRepresentationRecord
  ↘/biom:SourceVideo
or
/itl:PackageSourceRepresentationRecord
  ↘/biom:SourceImage
endif

```

Summary

How the record is being used.

Notes

Applies to 20.004, 20.005, 20.006, 20.007, 20.008, 20.009, 20.010, 20.011, 20.012, 20.013, 20.016, 20.017, 20.018, 20.019, 20.903, 20.904, 20.993, 20.998, and 20.999

15.6. Biometric/Image Capture Detail (XML)

Field Reference: 20/SRC_20/GEO	Field ID: [20.004_20.998]
Content Type: Set_X	Condition: Optional
XML Tag Name: ImageCaptureDetail or BiometricCaptureDetail	Defined in: xsd/niem/biometrics/1.0/biometrics.xsd
Data Type:	Special Characters: <i>n/a</i>
Minimum Length:	Maximum Length:
Minimum Occurrences: 0	Maximum Occurrences: 1
Value range: <i>n/a</i>	Regular Expression: <i>n/a</i>
Code table: <i>n/a</i>	
Base type: biom:BiometricCaptureType or biom:ImageCaptureType	Namespace: http://niem.gov/niem/biometrics/1.0

XPath

```

if [20/AQS/AQT] IN 1..6, 11 then
/itl:PackageSourceRepresentationRecord
  ↪/biom:SourceImage
    ↪/biom:ImageCaptureDetail
elseif [20/AQS/AQT] IN 7..10, 19..21 then
/itl:PackageSourceRepresentationRecord
  ↪/biom:SourceVideo
    ↪/biom:BiometricCaptureDetail
elseif [20/AQS/AQT] IN 12..18, 22..29 then
/itl:PackageSourceRepresentationRecord
  ↪/biom:SourceAudio
    ↪/biom:BiometricCaptureDetail
elseif [20/AQS/AQT] IN 0, 30, 31 then
/itl:PackageSourceRepresentationRecord
  ↪/biom:SourceAudio
    ↪/biom:BiometricCaptureDetail
or
/itl:PackageSourceRepresentationRecord
  ↪/biom:SourceVideo
    ↪/biom:BiometricCaptureDetail
or
/itl:PackageSourceRepresentationRecord
  ↪/biom:SourceImage
    ↪/biom:ImageCaptureDetail
endif

```

Summary

Image and associated information.

Notes

Applies to 20.004, 20.005, 20.006, 20.007, 20.008, 20.009, 20.010, 20.011, 20.013, 20.016, 20.017, 20.018, 20.019, 20.903, 20.904, 20.993, and 20.998

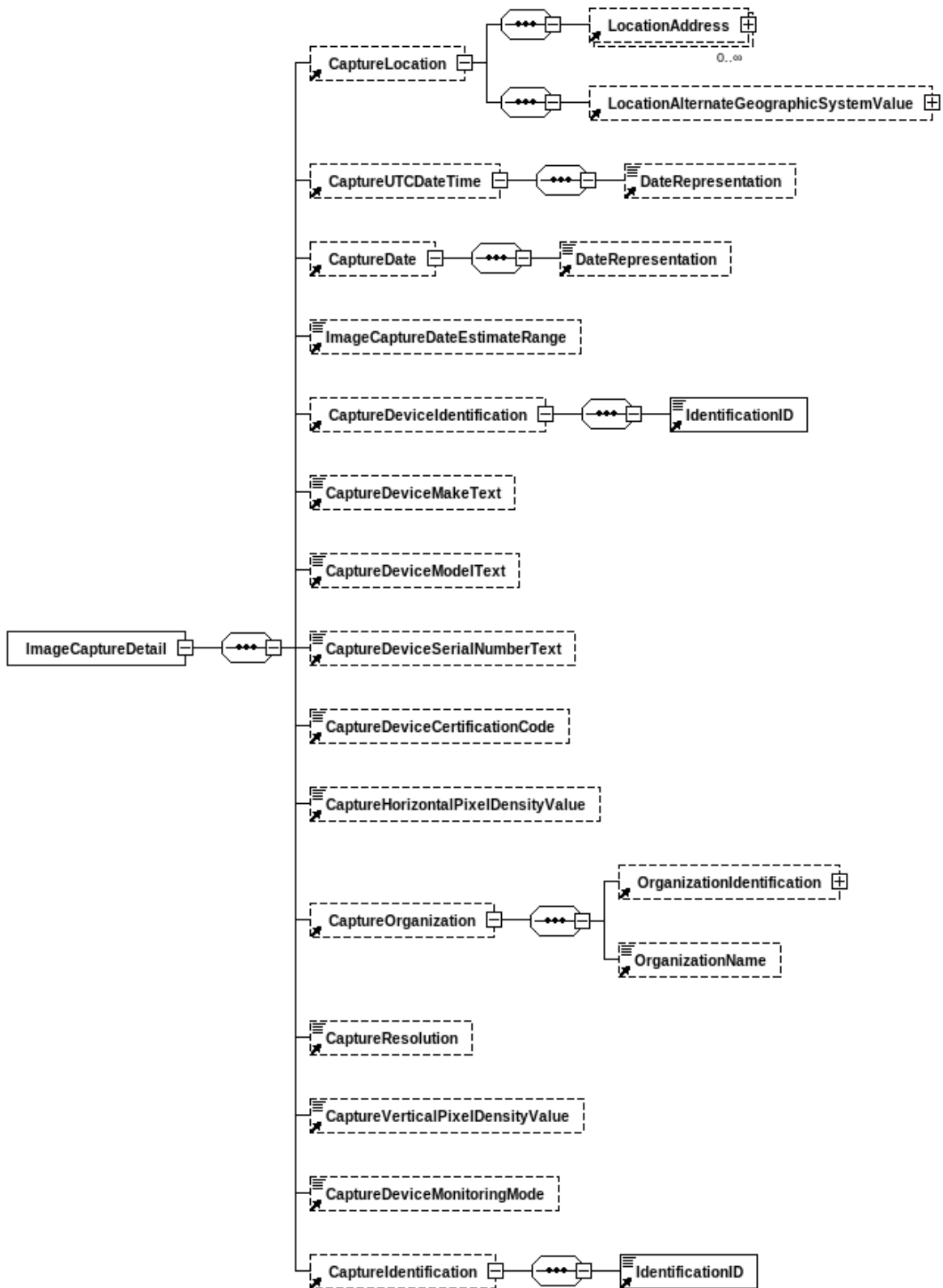

15.7. Capture Organization (XML)

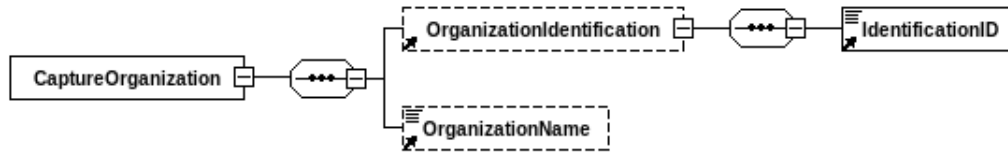

Field Reference: 20/SRC_20/SAN
Content Type: Set_X
XML Tag Name: CaptureOrganization
Data Type:
Minimum Length:
Minimum Occurrences: 1
Value range: *n/a*
Code table: *n/a*
Base type: nc:OrganizationType

Field ID: [20.004_20.993]
Condition: Mandatory
Defined in: xsd/niem/biometrics/1.0/biometrics.xsd
Special Characters: *n/a*
Maximum Length:
Maximum Occurrences: 1
Regular Expression: *n/a*
Namespace: <http://niem.gov/niem/biometrics/1.0>

XPath

```

if [20/AQS/AQT] IN 1..6, 11 then
/iitl:PackageSourceRepresentationRecord
  ↪/biom:SourceImage
    ↪/biom:ImageCaptureDetail
      ↪/biom:CaptureOrganization
elseif [20/AQS/AQT] IN 7..10, 19..21 then
/iitl:PackageSourceRepresentationRecord
  ↪/biom:SourceVideo
    ↪/biom:BiometricCaptureDetail
      ↪/biom:CaptureOrganization
elseif [20/AQS/AQT] IN 12..18, 22..29 then
/iitl:PackageSourceRepresentationRecord
  ↪/biom:SourceAudio
    ↪/biom:BiometricCaptureDetail
      ↪/biom:CaptureOrganization
elseif [20/AQS/AQT] IN 0, 30, 31 then
/iitl:PackageSourceRepresentationRecord
  ↪/biom:SourceAudio
    ↪/biom:BiometricCaptureDetail
      ↪/biom:CaptureOrganization
or
/iitl:PackageSourceRepresentationRecord
  ↪/biom:SourceVideo
    ↪/biom:BiometricCaptureDetail
      ↪/biom:CaptureOrganization
or
/iitl:PackageSourceRepresentationRecord
  ↪/biom:SourceImage
    ↪/biom:ImageCaptureDetail
      ↪/biom:CaptureOrganization
endif
  
```

Summary

Identifier of agency that created record and supplied information contained in it.

Notes

Applies to 20.004 and 20.993

15.8. Source Agency - SRC

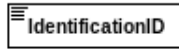

Field Reference: 20/SRC	Field ID: [20.004]
Content Type: Data	Condition: Mandatory
XML Tag Name: IdentificationID	Defined in: xsd/niem/niem-core/2.0/niem-core.xsd
Data Type: U	Special Characters: <i>n/a</i>
Minimum Length: 1	Maximum Length: *
Minimum Occurrences: 1	Maximum Occurrences: 1
Value range: <i>n/a</i>	Regular Expression: <i>n/a</i>
Code table: <i>n/a</i>	
Base type: niem-xsd:string	Namespace: http://niem.gov/niem/niem-core/2.0

XPath

```

if [20/AQS/AQT] IN 1..6, 11 then
/itl:PackageSourceRepresentationRecord
  ↳/biom:SourceImage
    ↳/biom:ImageCaptureDetail
      ↳/biom:CaptureOrganization
        ↳/nc:OrganizationIdentification
          ↳/nc:IdentificationID
elseif [20/AQS/AQT] IN 7..10, 19..21 then
/itl:PackageSourceRepresentationRecord
  ↳/biom:SourceVideo
    ↳/biom:BiometricCaptureDetail
      ↳/biom:CaptureOrganization
        ↳/nc:OrganizationIdentification
          ↳/nc:IdentificationID
elseif [20/AQS/AQT] IN 12..18, 22..29 then
/itl:PackageSourceRepresentationRecord
  ↳/biom:SourceAudio
    ↳/biom:BiometricCaptureDetail
      ↳/biom:CaptureOrganization
        ↳/nc:OrganizationIdentification
          ↳/nc:IdentificationID
elseif [20/AQS/AQT] IN 0, 30, 31 then
/itl:PackageSourceRepresentationRecord
  ↳/biom:SourceAudio
    ↳/biom:BiometricCaptureDetail
      ↳/biom:CaptureOrganization
        ↳/nc:OrganizationIdentification
          ↳/nc:IdentificationID
or
/itl:PackageSourceRepresentationRecord
  ↳/biom:SourceVideo
    ↳/biom:BiometricCaptureDetail
      ↳/biom:CaptureOrganization
        ↳/nc:OrganizationIdentification
          ↳/nc:IdentificationID
or
/itl:PackageSourceRepresentationRecord
  ↳/biom:SourceImage
    ↳/biom:ImageCaptureDetail
      ↳/biom:CaptureOrganization
        ↳/nc:OrganizationIdentification
          ↳/nc:IdentificationID

```

15. Source Representation Record (aka Type 20)

endif

Summary

Identifier of agency that created and supplied information contained in the record. The source agency name may be entered in 20.993.

Valid Examples

```
<nc:IdentificationID>WI013415Y</nc:IdentificationID>
```

15.9. Source Representation Date (XML) - SRD



Field Reference: 20/SRD:X

Content Type: Data_X

XML Tag Name: DateTime

Data Type: NS

Minimum Length: 12

Minimum Occurrences: 0

Value range: *n/a*

Code table: *n/a*

Base type: [niem-xsd:dateTime](#)

Field ID: [20.005:X]

Condition: Optional

Defined in: [xsd/niem/niem-core/2.0/niem-core.xsd](#)

Special Characters: [-:]

Maximum Length: 16

Maximum Occurrences: 1

Regular Expression: \d{4}-\d{2}-\d{2}T\d{2}:\d{2}

Namespace: <http://niem.gov/niem/niem-core/2.0>

XPath

```

if [20/AQS/AQT] IN 1..6, 11 then
/itl:PackageSourceRepresentationRecord
  ↳/biom:SourceImage
    ↳/biom:ImageCaptureDetail
      ↳/biom:CaptureDate
        ↳/nc:DateTime
elseif [20/AQS/AQT] IN 7..10, 19..21 then
/itl:PackageSourceRepresentationRecord
  ↳/biom:SourceVideo
    ↳/biom:BiometricCaptureDetail
      ↳/biom:CaptureDate
        ↳/nc:DateTime
elseif [20/AQS/AQT] IN 12..18, 22..29 then
/itl:PackageSourceRepresentationRecord
  ↳/biom:SourceAudio
    ↳/biom:BiometricCaptureDetail
      ↳/biom:CaptureDate
        ↳/nc:DateTime
elseif [20/AQS/AQT] IN 0, 30, 31 then
/itl:PackageSourceRepresentationRecord
  ↳/biom:SourceAudio
    ↳/biom:BiometricCaptureDetail
      ↳/biom:CaptureDate
        ↳/nc:DateTime
or
/itl:PackageSourceRepresentationRecord
  ↳/biom:SourceVideo
    ↳/biom:BiometricCaptureDetail
      ↳/biom:CaptureDate
        ↳/nc:DateTime
or
/itl:PackageSourceRepresentationRecord
  ↳/biom:SourceImage
    ↳/biom:ImageCaptureDetail
      ↳/biom:CaptureDate
        ↳/nc:DateTime
endif

```

Summary

Date and time that the source representation contained in the record was captured.

15. Source Representation Record (aka Type 20)

Notes

This field uses the Local Date & Time format found in section 7.7.2.4.

Valid Examples

```
<nc:DateTime>2011-01-01T05:25</nc:DateTime>
```

15.10. Horizontal Line Length - HLL

 ImageHorizontalLineLengthPixelQuantity
--

Field Reference: 20/HLL

Content Type: Data

XML Tag Name: ImageHorizontalLineLengthPixelQuantity

Data Type: N

Minimum Length: 2

Minimum Occurrences: 0

Value range: {10..99999}

Code table: *n/a*

Base type: niem-xsd:integer

Field ID: [20.006]

Condition: Dependent (see table)

Defined in: xsd/niem/biometrics/1.0/biometrics.xsd

Special Characters: *n/a*

Maximum Length: 5

Maximum Occurrences: 1

Regular Expression: *n/a*

Namespace: <http://niem.gov/niem/biometrics/1.0>

Dependency table

Type of dependency	Value
Other Dependency	Mandatory if a 2D still image is contained in this instance of the record. Otherwise, it shall be omitted.

XPath

```
/it1:PackageSourceRepresentationRecord
  ↳/biom:SourceImage
    ↳/biom:ImageHorizontalLineLengthPixelQuantity
```

Summary

Number of pixels contained on a single horizontal line of the image.

Technical Notes

Mandatory if a 2D still image is contained in this instance of the record. Otherwise, it shall be omitted.

Valid Examples

```
<biom:ImageHorizontalLineLengthPixelQuantity>80</biom:ImageHorizontalLineLengthPixelQuantity>
```

15.11. Vertical Line Length - VLL

ImageVerticalLineLengthPixelQuantity

Field Reference: 20/VLL

Content Type: Data

XML Tag Name: ImageVerticalLineLengthPixelQuantity

Data Type: N

Minimum Length: 2

Minimum Occurrences: 0

Value range: {10..99999}

Code table: *n/a*

Base type: niem-xsd:integer

Field ID: [20.007]

Condition: Dependent (see table)

Defined in: xsd/niem/biometrics/1.0/biometrics.xsd

Special Characters: *n/a*

Maximum Length: 5

Maximum Occurrences: 1

Regular Expression: *n/a*

Namespace: <http://niem.gov/niem/biometrics/1.0>

Dependency table

Type of dependency	Value
Other Dependency	Mandatory if a 2D still image is contained in this instance of the record. Otherwise, it shall be omitted.

XPath

```
/it1:PackageSourceRepresentationRecord
  ↳/biom:SourceImage
    ↳/biom:ImageVerticalLineLengthPixelQuantity
```

Summary

Number of pixels contained on a single vertical line of the image.

Technical Notes

Mandatory if a 2D still image is contained in this instance of the record. Otherwise, it shall be omitted.

Valid Examples

```
<biom:ImageVerticalLineLengthPixelQuantity>65</biom:ImageVerticalLineLengthPixelQuantity>
```

15.12. Scale Units - SLC

ImageScaleUnitsCode

Field Reference: 20/SLC

Content Type: Data

XML Tag Name: ImageScaleUnitsCode

Data Type: N

Minimum Length: 1

Minimum Occurrences: 0

Value range: {1..2}

Code table: see table [A.59](#)

Base type: biom:ScaleUnitsCodeType

Field ID: [20.008]

Condition: Dependent (see table)

Defined in: xsd/niem/biometrics/1.0/biometrics.xsd

Special Characters: *n/a*

Maximum Length: 1

Maximum Occurrences: 1

Regular Expression: *n/a*

Namespace: <http://niem.gov/niem/biometrics/1.0>

Dependency table

Type of dependency	Value
Other Dependency	Mandatory if a 2D still image is contained in this instance of the record. Otherwise, it shall be omitted

XPath

```
/itl:PackageSourceRepresentationRecord
  ↙/biom:SourceImage
    ↙/biom:ImageScaleUnitsCode
```

Summary

Image sampling frequency (pixel density).

Notes

Code 0 is not allowed in INTERPOL's implementation: the scale must be provided.

Technical Notes

Mandatory if a 2D still image is contained in this instance of the record. Otherwise, it shall be omitted

Valid Examples

```
<biom:ImageScaleUnitsCode>1</biom:ImageScaleUnitsCode>
```

15.13. Transmitted Horizontal Pixel Scale - THPS

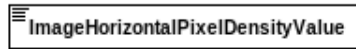

Field Reference: 20/THPS	Field ID: [20.009]
Content Type: Data	Condition: Dependent (see table)
XML Tag Name: ImageHorizontalPixelDensityValue	Defined in: xsd/niem/biometrics/1.0/biometrics.xsd
Data Type: N	Special Characters: <i>n/a</i>
Minimum Length: 1	Maximum Length: 5
Minimum Occurrences: 0	Maximum Occurrences: 1
Value range: {10..99999}	Regular Expression: <i>n/a</i>
Code table: <i>n/a</i>	
Base type: niem-xsd:nonNegativeInteger	Namespace: http://niem.gov/niem/biometrics/1.0

Dependency table

Type of dependency	Value
Other Dependency	Mandatory if a 2D still image is contained in this instance of the record. Otherwise, it shall be omitted. If 20/SLC={1,2}, then THPS shall equal TVPS.

XPath

```
/itl:PackageSourceRepresentationRecord
  ↙/biom:SourceImage
    ↙/biom:ImageHorizontalPixelDensityValue
```

Summary

Integer pixel density in the horizontal direction (if 20/SLC = 1 or 2); otherwise, if 20/SLC = 0, the horizontal component of the pixel aspect ratio.

Notes

For example, if the SLC value = 1, then the value of THPS could be '1000' for a 1000 ppi sensor.

Technical Notes

Mandatory if a 2D still image is contained in this instance of the record. Otherwise, it shall be omitted. If 20/SLC=1,2, then THPS shall equal TVPS.

Valid Examples

```
<biom:ImageHorizontalPixelDensityValue>1000</biom:ImageHorizontalPixelDensityValue>
```

15.14. Transmitted Vertical Pixel Scale - TVPS

 ImageVerticalPixelDensityValue

Field Reference: 20/TVPS	Field ID: [20.010]
Content Type: Data	Condition: Dependent (see table)
XML Tag Name: ImageVerticalPixelDensityValue	Defined in: xsd/niem/biometrics/1.0/biometrics.xsd
Data Type: N	Special Characters: <i>n/a</i>
Minimum Length: 1	Maximum Length: 5
Minimum Occurrences: 0	Maximum Occurrences: 1
Value range: {10..99999}	Regular Expression: <i>n/a</i>
Code table: <i>n/a</i>	
Base type: niem-xsd:nonNegativeInteger	Namespace: http://niem.gov/niem/biometrics/1.0

Dependency table

Type of dependency	Value
Other Dependency	Mandatory if a 2D still image is contained in this instance of the record. Otherwise, it shall be omitted. If 20/SLC={1,2}, then THPS shall equal TVPS.

XPath

```
/it1:PackageSourceRepresentationRecord
  ↳/biom:SourceImage
    ↳/biom:ImageVerticalPixelDensityValue
```

Summary

Integer pixel density in the vertical direction (if 20/SLC = 1 or 2); otherwise, if 20/SLC = 0, the vertical component of the pixel aspect ratio.

Technical Notes

Mandatory if a 2D still image is contained in this instance of the record. Otherwise, it shall be omitted. If 20/SLC=1,2, then THPS shall equal TVPS.

Valid Examples

```
<biom:ImageVerticalPixelDensityValue>1000</biom:ImageVerticalPixelDensityValue>
```

15.15. Compression Algorithm - CGA

 ImageCompressionAlgorithmText
--

Field Reference: 20/CGA

Content Type: Data

XML Tag Name: ImageCompressionAlgorithmText

Data Type: AN

Minimum Length: 3

Minimum Occurrences: 0

Value range: *n/a*

Code table: see table A.6

Base type: nc:TextType

Field ID: [20.011]

Condition: Dependent (see table)

Defined in: xsd/niem/biometrics/1.0/biometrics.xsd

Special Characters: *n/a*

Maximum Length: 5

Maximum Occurrences: 1

Regular Expression: *n/a*

Namespace: <http://niem.gov/niem/biometrics/1.0>

Dependency table

Type of dependency	Value
Other Dependency	Mandatory if a 2D still image is included in this record. Otherwise, it shall be omitted.

XPath

```
/it1:PackageSourceRepresentationRecord
  ↳/biom:SourceImage
    ↳/biom:ImageCompressionAlgorithmText
```

Summary

Algorithm used to compress the transmitted images.

Notes

As Type 20 is meant to transmit evidences in INTERPOL's implementation, it is recommended to use lossless algorithms to compress it.

Technical Notes

Mandatory if a 2D still image is included in this record. Otherwise, it shall be omitted.

Valid Examples

```
<biom:ImageCompressionAlgorithmText>JP2</biom:ImageCompressionAlgorithmText>
```

15.16. Bits Per Pixel - BPX

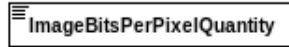

Field Reference: 20/BPX

Content Type: Data

XML Tag Name: ImageBitsPerPixelQuantity

Data Type: N

Minimum Length: 1

Minimum Occurrences: 0

Value range: *n/a*

Code table: *n/a*

Base type: niem-xsd:nonNegativeInteger

Field ID: [20.012]

Condition: Dependent (see table)

Defined in: xsd/niem/biometrics/1.0/biometrics.xsd

Special Characters: *n/a*

Maximum Length: 2

Maximum Occurrences: 1

Regular Expression: *n/a*

Namespace: <http://niem.gov/niem/biometrics/1.0>

Dependency table

Type of dependency	Value
Other Dependency	Mandatory if a 2D still image is contained in this instance of the record. Otherwise, it shall be omitted.

XPath

```
/itl:PackageSourceRepresentationRecord
  ↳/biom:SourceImage
    ↳/biom:ImageBitsPerPixelQuantity
```

Summary

Number of bits per pixel.

Notes

This field shall contain an entry of "8" for normal grayscale values of "0" to "255". Any entry in this field greater than "8" shall be used to represent a grayscale pixel with increased proportion. For color, BPX represents the total number of bits per pixel (not per color). For instance, BPX=24 represents a 24-bit RGB image using 8 bits for each color.

Technical Notes

Mandatory if a 2D still image is contained in this instance of the record. Otherwise, it shall be omitted.

Valid Examples

```
<biom:ImageBitsPerPixelQuantity>8</biom:ImageBitsPerPixelQuantity>
```

15.17. Color Space - CSP

 ImageColorSpaceCode

Field Reference: 20/CSP

Content Type: Data

XML Tag Name: ImageColorSpaceCode

Data Type: A

Minimum Length: 3

Minimum Occurrences: 0

Value range: *n/a*

Code table: see table [A.14](#)

Base type: biom:ColorSpaceCodeType

Field ID: [20.013]

Condition: Dependent (see table)

Defined in: xsd/niem/biometrics/1.0/biometrics.xsd

Special Characters: *n/a*

Maximum Length: 4

Maximum Occurrences: 1

Regular Expression: *n/a*

Namespace: <http://niem.gov/niem/biometrics/1.0>

Dependency table

Type of dependency	Value
Other Dependency	Mandatory if a 2D still image is contained in this instance of the record. Otherwise, it shall be omitted.

XPath

```
/it1:PackageSourceRepresentationRecord
  ↳/biom:SourceImage
    ↳/biom:ImageColorSpaceCode
```

Summary

Image color space.

Notes

See Section 7.7.10.3 Color Image Data for a detailed description of this field.

Technical Notes

Mandatory if a 2D still image is contained in this instance of the record. Otherwise, it shall be omitted.

Valid Examples

```
<biom:ImageColorSpaceCode>GRAY</biom:ImageColorSpaceCode>
```

15.18. Acquisition Source - AQS

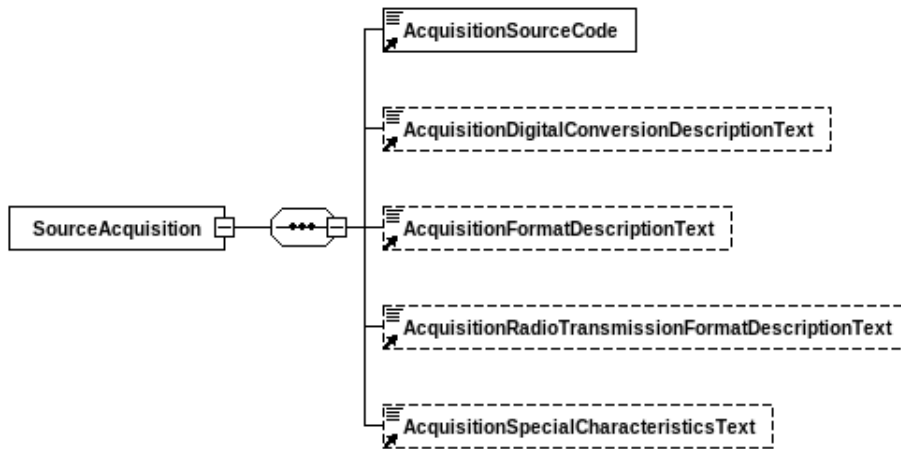

Field Reference: 20/AQS
Content Type: Set
XML Tag Name: SourceAcquisition
Data Type:
Minimum Length:
Minimum Occurrences: 1
Value range: *n/a*
Code table: *n/a*
Base type: biom:SourceAcquisitionType

Field ID: [20.014]
Condition: Mandatory
Defined in: xsd/niem/biometrics/1.0/biometrics.xsd
Special Characters: *n/a*
Maximum Length:
Maximum Occurrences: 9
Regular Expression: *n/a*
Namespace: <http://niem.gov/niem/biometrics/1.0>

XPath

```

/itl:PackageSourceRepresentationRecord
  ↳/biom:SourceAcquisition
    
```

Summary

Describes the acquisition source.

15.19. Acquisition Source Type - AQT

 AcquisitionSourceCode

Field Reference: 20/AQS/AQT

Content Type: Data

XML Tag Name: AcquisitionSourceCode

Data Type: N

Minimum Length: 1

Minimum Occurrences: 1

Value range: {0..6}

Code table: see table [A.3](#)

Base type: biom:AcquisitionSourceCodeType

Field ID: [20.014-A]

Condition: Mandatory within a field

Defined in: xsd/niem/biometrics/1.0/biometrics.xsd

Special Characters: *n/a*

Maximum Length: 2

Maximum Occurrences: 1

Regular Expression: *n/a*

Namespace: <http://niem.gov/niem/biometrics/1.0>

XPath

```
/it1:PackageSourceRepresentationRecord  
  ↳/biom:SourceAcquisition  
    ↳/biom:AcquisitionSourceCode
```

Summary

Acquisition source type.

Notes

INTERPOL's implementation only allows still images acquired with a camera or a scanner.

Valid Examples

```
<biom:AcquisitionSourceCode>6</biom:AcquisitionSourceCode>
```

15.20. Analog to Digital Conversion - A2D

Field Reference: 20/AQS/A2D	Field ID: [20.014-B]
Content Type: Data	Condition: ?
XML Tag Name: AcquisitionDigitalConversionDescriptionText	Defined in: xsd/niem/biometrics/1.0/biometrics.xsd
Data Type: U	Special Characters: <i>n/a</i>
Minimum Length: 1	Maximum Length: 200
Minimum Occurrences: 0	Maximum Occurrences: 1
Value range: <i>n/a</i>	Regular Expression: <i>n/a</i>
Code table: <i>n/a</i>	
Base type: nc:TextType	Namespace: http://niem.gov/niem/biometrics/1.0

Dependency table

Type of dependency	Value
Mandatory on Value of other Field, optional otherwise.	[20/AQS/AQT]IN{9,13}

XPath

```
/it1:PackageSourceRepresentationRecord
  ↳/biom:SourceAcquisition
    ↳/biom:AcquisitionDigitalConversionDescriptionText
```

Summary

Describes the analog to digital equipment used to transform the source. This field should address parameters used, such as sample rate, if known.

15.21. Acquisition Special Characteristics - AQSC

Field Reference: 20/AQS/AQSC	Field ID: [20.014-D]
Content Type: Data	Condition: Optional within a field
XML Tag Name: AcquisitionSpecialCharacteristicsText	Defined in: xsd/niem/biometrics/1.0/biometrics.xsd
Data Type: U	Special Characters: <i>n/a</i>
Minimum Length: 1	Maximum Length: 200
Minimum Occurrences: 0	Maximum Occurrences: 1
Value range: <i>n/a</i>	Regular Expression: <i>n/a</i>
Code table: <i>n/a</i>	
Base type: nc:TextType	Namespace: http://niem.gov/niem/biometrics/1.0

XPath

```
/itl:PackageSourceRepresentationRecord  
  ↳/biom:SourceAcquisition  
    ↳/biom:AcquisitionSpecialCharacteristicsText
```

Summary

Free text field which describes any specific conditions not mentioned in the table.

Valid Examples

```
<biom:AcquisitionSpecialCharacteristicsText>Near-infrared camera outputting images in visible wavelengths</biom:  
  AcquisitionSpecialCharacteristicsText>
```

15.22. Source Representation Format - SFT

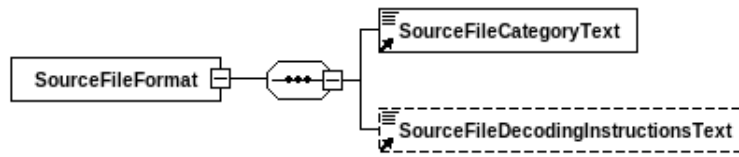

Field Reference: 20/SFT

Content Type: Set

XML Tag Name: SourceFileFormat

Data Type:

Minimum Length:

Minimum Occurrences: 1

Value range: *n/a*

Code table: *n/a*

Base type: biom:SourceFileFormatType

Field ID: [20.015]

Condition: Mandatory

Defined in: xsd/niem/biometrics/1.0/biometrics.xsd

Special Characters: *n/a*

Maximum Length:

Maximum Occurrences: 1

Regular Expression: *n/a*

Namespace: <http://niem.gov/niem/biometrics/1.0>

XPath

```
/it1:PackageSourceRepresentationRecord
  ↳/biom:SourceFileFormat
```

Summary

Source representation format.

15.23. File Type - FTY

 SourceFileCategoryText

Field Reference: 20/SFT/FTY

Content Type: Data

XML Tag Name: SourceFileCategoryText

Data Type: U

Minimum Length: 3

Minimum Occurrences: 1

Value range: *n/a*

Code table: see table [A.30](#) *

Base type: nc:TextType

Field ID: [20.015-A]

Condition: Mandatory within a field

Defined in: [xsd/niem/biometrics/1.0/biometrics.xsd](#)

Special Characters: *n/a*

Maximum Length: 6

Maximum Occurrences: 1

Regular Expression: *n/a*

Namespace: <http://niem.gov/niem/biometrics/1.0>

XPath

```
/it1:PackageSourceRepresentationRecord
  ↳/biom:SourceFileFormat
    ↳/biom:SourceFileCategoryText
```

Summary

File type. If the source representation is a digital file, this shall contain the suffix indicating the file type (such as JPG).

Valid Examples

```
<biom:SourceFileCategoryText>ANALOG</biom:SourceFileCategoryText>
```

*The code table is optional, defining commonly-used or special-purpose values, rather than definitive (listing all possible values).

15.24. Decoding Instructions - DEI

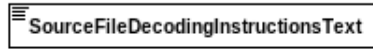

Field Reference: 20/SFT/DEI

Content Type: Data

XML Tag Name: SourceFileDecodingInstructionsText

Data Type: U

Minimum Length: 1

Minimum Occurrences: 0

Value range: *n/a*

Code table: *n/a*

Base type: nc:TextType

Field ID: [20.015-B]

Condition: Optional within a field

Defined in: xsd/niem/biometrics/1.0/biometrics.xsd

Special Characters: *n/a*

Maximum Length: 1000

Maximum Occurrences: 1

Regular Expression: *n/a*

Namespace: <http://niem.gov/niem/biometrics/1.0>

XPath

```
/it1:PackageSourceRepresentationRecord
  ↳/biom:SourceFileFormat
    ↳/biom:SourceFileDecodingInstructionsText
```

Summary

Free text providing decoding instructions.

15.25. Source Representation Number - SRN

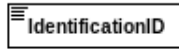

Field Reference: 20/SRN

Content Type: Data

XML Tag Name: IdentificationID

Data Type: N

Minimum Length: 1

Minimum Occurrences: 1

Value range: {1}

Code table: *n/a*

Base type: niem-xsd:string

Field ID: [20.021]

Condition: Mandatory

Defined in: xsd/niem/niem-core/2.0/niem-core.xsd

Special Characters: *n/a*

Maximum Length: 3

Maximum Occurrences: 1

Regular Expression: *n/a*

Namespace: <http://niem.gov/niem/niem-core/2.0>

XPath

```
/it1:PackageSourceRepresentationRecord  
  ↳/biom:SourceIdentification  
    ↳/nc:IdentificationID
```

Summary

Reference number for the source representation stored in this record. It is an integer, numbered sequentially beginning at one and incremented for each instance of Record Type-20.

Valid Examples

```
<nc:IdentificationID>8</nc:IdentificationID>
```

15.26. Source Representation Data - DATA

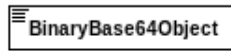

Field Reference: 20/DATA

Content Type: Data

XML Tag Name: BinaryBase64Object

Data Type: B

Minimum Length: 1

Minimum Occurrences: 0

Value range: *n/a*

Code table: *n/a*

Base type: niem-xsd:base64Binary

Field ID: [20.999]

Condition: Dependent (see table)

Defined in: xsd/niem/niem-core/2.0/niem-core.xsd

Special Characters: *n/a*

Maximum Length: *

Maximum Occurrences: 1

Regular Expression: *n/a*

Namespace: <http://niem.gov/niem/niem-core/2.0>

Exceptions

see Technical Notes below

Dependency table

Type of dependency	Value
Mandatory on Absence of other Field	20/EFR

XPath

```

if [20/AQS/AQT] IN 1..6, 11 then
/itl:PackageSourceRepresentationRecord
  ↘/biom:SourceImage
    ↘/nc:BinaryBase64Object
elseif [20/AQS/AQT] IN 7..10, 19..21 then
/itl:PackageSourceRepresentationRecord
  ↘/biom:SourceVideo
    ↘/nc:BinaryBase64Object
elseif [20/AQS/AQT] IN 12..18, 22..29 then
/itl:PackageSourceRepresentationRecord
  ↘/biom:SourceAudio
    ↘/nc:BinaryBase64Object
elseif [20/AQS/AQT] IN 0, 30, 31 then
/itl:PackageSourceRepresentationRecord
  ↘/biom:SourceImage
    ↘/nc:BinaryBase64Object
or
/itl:PackageSourceRepresentationRecord
  ↘/biom:SourceVideo
    ↘/nc:BinaryBase64Object
or
/itl:PackageSourceRepresentationRecord
  ↘/biom:SourceAudio
    ↘/nc:BinaryBase64Object
endif

```

Summary

Data associated with the record.

Notes

Binary for Traditional encoding or Base64 for XML

15. Source Representation Record (aka Type 20)

Technical Notes

Field is mandatory for a 2D still image. One of the two fields (20.994 or 20.999) shall be present in all instances of this record type.

Valid Examples

```
<nc:BinaryBase64Object>mrHbPdrko3u1s7ahtgPBjtm01s85tfG2U7bpofY94Czu2SbY7d7wF9fQ7ZptgGrtk02a2dsJ7wZbe8BlzvAmQ7xq+  
Y94GoHeEsR3ikWd4DIGhmp3k42d4DRmzs94DKveDTB3hqw6PeBLrtpPep0H/+h</nc:BinaryBase64Object>
```

15.27. Field Mandatoriness in Source Representation Record

The following table shows a summary of the fields and information items in each record type and its corresponding XML elements, and in particular the fields and items that are mandatory.

Table 15.1.: Field Summary for Type 20 Records

Field Id	Code	Field Name	Card.	Notes
20/XRCC:X	[20.001:X]	XML Record Category Code	M	
20/IDC	[20.002]	Information Designation Character	M	
20/CAR	[20.003]	SRN Cardinality	M	
20/SRC_20/DATA	[20.004_20.999]	Source Type (XML)	M	
20/SRC_20/GEO	[20.004_20.998]	Biometric/Image Capture Detail (XML)	O	
20/SRC_20/SAN	[20.004_20.993]	Capture Organization (XML)	M	
20/SRC	[20.004]	Source Agency	M	
20/SRD:X	[20.005:X]	Source Representation Date (XML)	O	
20/HLL	[20.006]	Horizontal Line Length	D	Mandatory if a 2D still image is contained in this instance of the record. Otherwise, it shall be omitted.
20/VLL	[20.007]	Vertical Line Length	D	Mandatory if a 2D still image is contained in this instance of the record. Otherwise, it shall be omitted.
20/SLC	[20.008]	Scale Units	D	Mandatory if a 2D still image is contained in this instance of the record. Otherwise, it shall be omitted.
20/THPS	[20.009]	Transmitted Horizontal Pixel Scale	D	Mandatory if a 2D still image is contained in this instance of the record. Otherwise, it shall be omitted. If 20/SLC=1,2, then THPS shall equal TVPS.
20/TVPS	[20.010]	Transmitted Vertical Pixel Scale	D	Mandatory if a 2D still image is contained in this instance of the record. Otherwise, it shall be omitted. If 20/SLC=1,2, then THPS shall equal TVPS.
20/CGA	[20.011]	Compression Algorithm	D	Mandatory if a 2D still image is included in this record. Otherwise, it shall be omitted.
20/BPX	[20.012]	Bits Per Pixel	D	Mandatory if a 2D still image is contained in this instance of the record. Otherwise, it shall be omitted.
20/CSP	[20.013]	Color Space	D	Mandatory if a 2D still image is contained in this instance of the record. Otherwise, it shall be omitted.
20/AQS	[20.014]	Acquisition Source	M	
20/AQS/AQT	[20.014-A]	Acquisition Source Type	M [^]	
20/AQS/A2D	[20.014-B]	Analog to Digital Conversion	D [^]	This field is required (and optional otherwise) if [20/AQS/AQT]IN9,13
20/AQS/AQSC	[20.014-D]	Acquisition Special Characteristics	O [^]	
20/SFT	[20.015]	Source Representation Format	M	
20/SFT/FTY	[20.015-A]	File Type	M [^]	
20/SFT/DEI	[20.015-B]	Decoding Instructions	O [^]	
20/SRN	[20.021]	Source Representation Number	M	
20/DATA	[20.999]	Source Representation Data	D	<ul style="list-style-type: none"> This field is only permitted if 20/EFR is/are absent. Field is mandatory for a 2D still image. One of the two fields (20.994 or 20.999) shall be present in all instances of this record type.

M=Mandatory, O=Optional, M[^]=Mandatory Info Item within a Field, O[^]=Optional Info Item within a Field, D=Dependent on other Fields/Info Items

Appendix A.

Code Tables

The following tables list codes used in INT-I XML in various fields. The bulk of these codes are directly taken from the ANSI/NIST-ITL 1-2011[ansi-nist-2011] through the use of the [MRT](#) found in [ansi-nist-mrt]. Some (TOT, SEX, ERR) are INT-I specific.

A.1. Table of Amputated or Bandaged Codes

Table A.1.: Table of Amputated or Bandaged Codes

Code	Description
UP	Unable to print (e.g., bandaged or completely amputated)
XX	Partial print due to amputation
SR	Scar

A.2. Table of Direction Uncertainty Codes

Table A.2.: Table of Direction Uncertainty Codes

Code	Description
180	Angle cannot be determined or is undefined

A.3. Table of Acquisition Source Type Codes

Table A.3.: Table of Acquisition Source Type Codes

Code	Description
0	Unspecified or unknown
1	Static digital image from an unknown source
2	Static digital image from a digital still-image camera
3	Static digital image from a scanner
4	Single video frame from an unknown source
5	Single video frame from an analog video camera
6	Single video frame from a digital video camera
7	Video sequence from an unknown source
8	Video sequence from an analog video camera, stored in analog format
9	Video sequence from an analog video camera, stored in digital format
10	Video sequence frame from a digital video camera
11	Computer screen image capture
12	Analog audio recording device; stored in analog form (such as a phonograph record)
13	Analog audio recording device; converted to digital
14	Digital audio recording device
15	Landline telephone - both sender and receiver
16	Mobile telephone - both sender and receiver
17	Satellite telephone - both sender and receiver
18	Telephone - unknown or mixed sources
19	Television - NSTC
20	Television - PAL
21	Television - Other
22	Voice-over-internet protocol (VOIP)
23	Radio transmission: short-wave (specify single side band or continuous wave in FDN)
24	Radio transmission: amateur radio (specify lower side band or continuous wave in FDN)
25	Radio transmission: FM (87.5 MHz to 108 MHz)
26	Radio transmission: long-wave (150 kHz to 519 kHz)
27	Radio transmission: AM (570 kHz to 1720 kHz)
28	Radio transmission: Aircraft frequencies
29	Radio transmission: Ship and coastal station frequencies
30	Vendor specific capture format
31	Other

A.4. Table of Source Cardinality Codes

Table A.4.: Table of Source Cardinality Codes

Code	Description
D	The representation in this Type-20 record is the source of one or more biometric type records, excluding Type-4 and Type-9, which have been derived from it
M	A single biometric type record, excluding Type-4 and Type-9, has been prepared from multiple Type-20 records
S	The representation in this Type-20 record is the source of another Type-20 record

A.5. Table of Appendix F Status Codes

Table A.5.: Table of Appendix F Status Codes

Code	Description
APPF	Acquisition equipment certified as compliant with FBI Appendix F specifications.
NONE	Acquisition equipment does not conform with FBI Appendix F specifications.

A.6. Table of Image Compression Algorithm Labels

Table A.6.: Table of Image Compression Algorithm Labels

Label	Standard Name
JP2	JPEG 2000, ISO/IEC 15444-1:2004 (Lossy)
JP2L	JPEG 2000, ISO/IEC 15444-1:2004 (Lossless)
JPEGB	JPEG, ISO/IEC 10918, JFIF 1.02:1992 (Lossy)
JPEGL	JPEG, ISO/IEC 10918, JFIF 1.02:1992 (Lossless)
NONE	Uncompressed (Lossless)
PNG	Portable Network Graphics (Lossless)
WSQ20	WSQ (Wavelet Scalar Quantization): Version 3.1 (Lossy)

A.7. Table of Civil Codes

Table A.7.: Table of Civil Codes

Code	Description
AMN	AMNESIA
CIT	CITIZENSHIP
DEC	DECEASED
IMM	MISSING PERSON
IU	UNIDENTIFIED BODIES
OTH	NOT LISTED REASON
VIS	VISA

A.8. Table of Permanent Flexion Crease Codes

Table A.8.: Table of Permanent Flexion Crease Codes

Code	Description
DIP	Distal interphalangeal crease
DTC	Distal transverse crease (top palm crease)
PDC00	Proximal digital crease, unknown finger
PDC01	Proximal digital crease, right thumb
PDC02	Proximal digital crease, right index finger
PDC03	Proximal digital crease, right middle finger
PDC04	Proximal digital crease, right ring finger
PDC05	Proximal digital crease, right little finger
PDC06	Proximal digital crease, left thumb
PDC07	Proximal digital crease, left index finger
PDC08	Proximal digital crease, left middle finger
PDC09	Proximal digital crease, left ring finger
PDC10	Proximal digital crease, left little finger
PDC16	Proximal digital crease, right extra digit
PDC17	Proximal digital crease, left extra digit
PIP	Proximal interphalangeal crease
PTC	Proximal transverse crease (middle palm crease)
RLC	Radial longitudinal crease (bottom palm crease)
WC	Wrist crease (wrist bracelet)

A.9. Table of Feature Field Number Codes

Table A.9.: Table of Feature Field Number Codes

Code	Description
320	Cores
321	Deltas
324	Distinctive Characteristics
331	Minutiae
340	Dots
341	Incipient Ridges
342	Creases and Linear Discontinuities
343	Ridge Edge Features
345	Pores
373	Ridge Path Segments

A.10. Table of Feature Correspondance Codes

Table A.10.: Table of Feature Correspondance Codes

Code	Description
DF	Possible or debatable correspondence (Feature)
DP	Possible or debatable correspondence (Point)
F	Definite correspondence (Feature)
P	Definite correspondence (Point)
R	Inconclusive (Out of region)
U	Inconclusive (Unclear area)
X	Definite lack of correspondence

A.11. Table of Center Location Method Codes

Table A.11.: Table of Center Location Method Codes

Code	Description
0	Uppermost point of the ridge with greatest curvature
1	Overall fingerprint focal point
H	Human estimate of finger center
L	Lateral center only

A.12. Table of CSI Codes

Table A.12.: Table of CSI Codes

Code	Description
0	7-bit ASCII (Default)
2	16 bit Unicode
3	8-bit Unicode
4	32-bit Unicode

A.13. Table of CSN Codes

Table A.13.: Table of CSN Codes

Code	Description
ASCII	7-bit ASCII (Default)
UTF-16	16 bit Unicode
UTF-32	32-bit Unicode
UTF-8	8-bit Unicode

A.14. Table of Image Color Space Codes

Table A.14.: Table of Image Color Space Codes

Code	Description
GRAY	Grayscale (monochrome)
RGB	Undetermined color space for an RGB image
SRGB	sRGB (IEC 61966-2-1)
SYCC	YCbCr (JPEG 2000 compressed)
UNK	Undefined
YCC	YCbCr (legacy)

A.15. Table of Delta Category Codes

Table A.15.: Table of Delta Category Codes

Code	Description
	Other delta
C	Carpal delta
I00	Interdigital delta, unknown finger
I02	Interdigital delta under right index finger
I03	Interdigital delta under right middle finger
I04	Interdigital delta under right ring finger
I05	Interdigital delta under right little finger
I07	Interdigital delta under left index finger
I08	Interdigital delta under left middle finger
I09	Interdigital delta under left ring finger
I10	Interdigital delta under left little finger
I16	Interdigital delta under right extra digit
I17	Interdigital delta under left extra digit
L	Left fingerprint delta
R	Right fingerprint delta

A.16. Table of Distinctive Feature Type Codes

Table A.16.: Table of Distinctive Feature Type Codes

Code	Description
CLEAR	Large clear field of ridges; large clear area with no minutiae
CORE	Unusually distinctive core area
CREASE	Unusually distinctive crease
DELTA	Unusually distinctive delta area
DYSPLASIA	Dissociated ridges / Dysplasia
MINGROUP	Unusual group or cluster of minutiae
MINUTIA	Unusually shaped minutia
OTHERFEAT	Other unusual features not characterized elsewhere; details should be noted in comments
SCAR	Scar
WART	Wart or blister

A.17. Table of Device Monitoring Mode Codes

Table A.17.: Table of Device Monitoring Mode Codes

Code	Description
ASSISTED	Person available to provide assistance to subject submitting the biometric
CONTROLLED	Operator physically controls the subject to acquire the biometric sample
OBSERVED	Person present to observe operation of the device but provides no assistance
UNATTENDED	No one present to observe or provide assistance
UNKNOWN	No information is known

A.18. Table of Value Assessment Codes

Table A.18.: Table of Value Assessment Codes

Code	Description
LIMITED	The impression is of limited, marginal, value. It is not of value for individualization, but may be appropriate for exclusion.
NONPRINT	The image is not a friction ridge impression.
NOVALUE	The impression is of no value, is not appropriate for further analysis, and has no use for potential comparison.
VALUE	The impression is of value and is appropriate for further analysis and potential comparison. Sufficient details exist to render an individualization and/or exclusion decision.

A.19. Table of Determination Result Codes

Table A.19.: Table of Determination Result Codes

Code	Description
EX_SRC	Exclusion of source
EX_SUB	Exclusion of subject
INC_C	Inconclusive, but with corresponding features noted
INC_D	Inconclusive, but with dissimilar features noted
INC_I	Inconclusive due to insufficient information
INC_N	Inconclusive due to no overlapping area
INDIV	Individualization
NONE	No determination

A.20. Table of EFS Feature Set Profile Codes

Table A.20.: Table of EFS Feature Set Profile Codes

Code	Description
0	Image-only profile
1	Minimal markup profile
2	Quick minutiae search profile
3	Detailed markup profile
10	Skeleton profile
11	Minutiae ridge count profile
20	Legacy IAFIS latent feature search profile
21	Quick minutiae search profile without image
30	Search response profile with all, and corresponding, minutiae
31	Search response profile without corresponding minutiae
90	Full annotation profile

A.21. Table of Fraud Type Codes

Table A.21.: Table of Fraud Type Codes

Code	Description
EVA	Evidence of evasion
FAB	Evidence of fabricated evidence
FOR	Evidence of forged evidence
SPO	Evidence of spoofing

A.22. Table of Error Codes

Table A.22.: Table of Error Codes

Code	Description
001	ERROR: RECORD NOT FOUND
002	ERROR: RECORD ALREADY EXISTS
003	ERROR: UNAUTHORISED ACCESS
101	ERROR: MANDATORY ELEMENT MISSING
102	ERROR: INVALID RECORD TYPE
103	ERROR: UNDEFINED ELEMENT
104	ERROR: EXCEED THE MAXIMUM OCCURRENCE
105	ERROR: INVALID NUMBER OF SUBELEMENTS
106	ERROR: ELEMENT LENGTH TOO SHORT
107	ERROR: ELEMENT LENGTH TOO LONG
108	ERROR: ELEMENT IS NOT A NUMBER AS EXPECTED
109	ERROR: ELEMENT NUMBER VALUE TOO SMALL
110	ERROR: ELEMENT NUMBER VALUE TOO BIG
111	ERROR: INVALID CHARACTER
112	ERROR: INVALID DATE
113	ERROR: INVALID TIME
114	ERROR: INVALID DATE OR TIME
115	ERROR: INVALID ITEM VALUE
116	ERROR: INVALID TYPE OF TRANSACTION
117	ERROR: INVALID RECORD DATA
118	ERROR: INVALID RECORD IMAGE SIZE
201	ERROR: INVALID TCN
501	ERROR: INSUFFICIENT FINGERPRINT QUALITY
502	ERROR: MISSING FINGERPRINTS
503	ERROR: FINGERPRINT SEQUENCE CHECK FAILED
999	ERROR: RECORD NOT FOUND

A.23. Table of Fingerprint Acquisition Profiles

Table A.23.: Table of Fingerprint Acquisition Profiles

Code	Description
10	FAP 10 (acquire rolled images = No; min scanning resolution = 490-510 ppi; min image dimensions = .5"x.65"; max compression ratio = 10:1; compression algorithm = WSQ v2.0 or above; simultaneous # fingers = 1; sensor certification = PIV)
20	FAP 20 (acquire rolled images = No; min scanning resolution = 490-510 ppi; min image dimensions = .6"x.8"; max compression ratio = 10:1; compression algorithm = WSQ v2.0 or above; simultaneous # fingers = 1; sensor certification = PIV)
30	FAP 30 (acquire rolled images = No; min scanning resolution = 490-510 ppi; min image dimensions = .8"x1.0"; max compression ratio = 10:1; compression algorithm = WSQ v2.0 or above; simultaneous # fingers = 1; sensor certification = PIV)
40	FAP 40 (acquire rolled images = optional; min scanning resolution = 490-510 ppi; min image dimensions = 1.6"x1.5"; max compression ratio = 15:1; compression algorithm = WSQ v2.0 or above; simultaneous # fingers = 1-2; sensor certification = PIV)
45	FAP 45 (acquire rolled images = optional; min scanning resolution = 495-505 ppi; min image dimensions = 1.6"x1.5"; max compression ratio = 15:1; compression algorithm = WSQ v2.0 or above; simultaneous # fingers = 1-2; sensor certification = Appendix F)
50	FAP 50 (acquire rolled images = optional; min scanning resolution = 495-505 ppi; min image dimensions = 2.5"x1.5"; min compression ratio = 15:1; compression algorithm = WSQ v3.1 or above; simultaneous # fingers = 1-3; sensor certification = Appendix F)
60	FAP 60 (acquire rolled images = optional; min scanning resolution = 495-505 ppi; min image dimensions = 3.2"x3.0"; min compression ratio = 15:1; compression algorithm = WSQ v3.1 or above; simultaneous # fingers = 1-4; sensor certification = Appendix F)

A.24. Table of Friction Ridge Capture Technology Codes

Table A.24.: Table of Friction Ridge Capture Technology Codes

Code	Description
0	Unknown Capture technology not provided by sensor manufacturer.
1	Other Capture technology not sufficiently characterized by table.
2	Scanned ink on paper Ink applied to friction ridge skin and then applied to paper, typically with assistance from a trained technician.
3	Optical - Total Internal Reflection (TIR) – bright field Using optical angle of incidence effects, a contact livescan device captures ridge information such that ridges absorb light, and absence of ridges reflects light back to the sensor (dark ridges on a white background).
4	Optical - TIR - dark field Using optical angle of incidence effects, a contact livescan device captures ridge information such that ridges reflect light, and absence of ridges absorb light (white ridges on a dark background).
5	Optical direct imaging – native Light reflected from the friction ridge is imaged, resulting in a light gray on darker gray image. This may be performed contact or contactless, and may incorporate merging images from multiple sensors or rocking or swaying sensors / subjects.
6	Optical direct imaging – low frequency unwrapped Light reflected from the friction ridge is imaged onto one or more sensors. This may be performed contact or contactless, and utilizes the low frequency 3D detail to “unwrap” or project the image texture onto a 2D grayscale image.
7	3-dimensional imaging – high frequency unwrapped High frequency friction ridge information is collected (optically, acoustically, etc.) and then “unwrapped” to create a 2D image from the 3D point cloud or mesh.
8	Reserved
9	Capacitive A contact technology in which the capacitance of the friction ridge skin is assessed via a conducted AC signal.
10	Capacitive – radio frequency (RF) A contact technology in which the capacitance of the friction ridge skin is assessed via a radiated RF signal.
11	Electro-luminescent (EL) optical direct imaging A contact technology in which the ridges and an alternating current (AC) signal cause an EL panel to emit light which is captured by an imaging system.
12	Reflected ultrasonic image A contact technology in which the friction ridge reflects ultrasonic energy which is assessed by the sensor.
13	Ultrasonic impediography A contact technology in which the absorption of ultrasonic energy is measured by changes in the impedance of a piezo-electric material.
14	Thermal imaging A contact technology in which the sensor measures the heat reflected from the friction ridge skin in contact with the sensor.
15	Direct pressure sensitive A contact technology in which the pressure of the fingerprint ridge skin against a material is measured.
16	Indirect pressure A contact technology in which the pressure of the fingerprint ridge skin against a deformable material is assessed optically to produce a friction ridge image.
17	Live tape (one time use) A technology in which tape is used on friction ridge skin to collect friction ridge detail and the tape is then subsequently imaged by traditional photography.
18	Latent impression A capture process in which the digital image of the latent impression is acquired directly from the latent impression, using a scanner or digital camera.
19	Latent photo Physical photograph of the latent impression subsequently scanned using a flatbed scanner or digital camera.
20	Latent molded / cast impression A capture process in which a mold / cast is taken from a latent friction ridge and then subsequently a “duplicate” is generated from moldable / printable material and imaged.

Table A.24.: Table of Friction Ridge Capture Technology Codes

Code	Description
21	Latent tracing An older legacy latent friction ridge capture process in which a hand-drawn or computer-drawn tracing would subsequently be imaged by a flatbed scanner or photographed.
22	Latent lif A process in which powder or a chemical is applied to a latent friction ridge print, subsequently transparent tape is applied to lift the print from the latent surface, and the tape is then placed on paper to be imaged.

A.25. Table of Generalized Fingerprint Position Codes

Table A.25.: Table of Generalized Fingerprint Position Codes

Code	Description	Code Group
00	Unknown finger (references every finger position from 1 - 10, 16, and 17)	Finger
01	Right thumb	Finger
02	Right index finger	Finger
03	Right middle finger	Finger
04	Right ring finger	Finger
05	Right little finger	Finger
06	Left thumb	Finger
07	Left index finger	Finger
08	Left middle finger	Finger
09	Left ring finger	Finger
10	Left little finger	Finger
11	Plain right thumb	Finger
12	Plain left thumb	Finger
13	Plain right four fingers (may include extra digits)	Finger
14	Plain left four fingers (may include extra digits)	Finger
15	Left & right thumbs	Finger
16	Right extra digit	Finger
17	Left extra digit	Finger
18	Unknown friction ridge (not known whether the print is from a hand or foot)	Unknown
19	EJI or tip (latent image that includes substantive portion of the medial or proximal segments of a finger, or the extreme tip of a fingerprint)	Finger
20	Unknown palm (references every listed palm print position)	Palm
21	Right full palm	Palm
22	Right writer's palm	Palm
23	Left full palm	Palm
24	Left writer's palm	Palm
25	Right lower palm	Palm
26	Right upper palm	Palm
27	Left lower palm	Palm
28	Left upper palm	Palm
29	Right other	Palm
30	Left other	Palm
31	Right interdigital	Palm
32	Right thenar	Palm
33	Right hypothenar	Palm
34	Left interdigital	Palm
35	Left thenar	Palm
36	Left hypothenar	Palm
37	Right grasp	Palm
38	Left grasp	Palm
40	Right index/middle	2 Fingers
41	Right middle/ring	2 Fingers
42	Right ring/little	2 Fingers
43	Left index/middle	2 Fingers
44	Left middle/ring	2 Fingers
45	Left ring/little	2 Fingers
46	Right index / left index	2 Fingers
47	Right index/middle/ring	3 Fingers
48	Right middle/ring/little	3 Fingers

Appendix A. Code Tables

Table A.25.: Table of Generalized Fingerprint Position Codes

Code	Description	Code Group
49	Left index/middle/ring	3 Fingers
50	Left middle/ring/little	3 Fingers
60	Unknown sole (references every listed plantar position)	Plantar
61	Sole - right foot	Plantar
62	Sole - left foot	Plantar
63	Unknown toe	Plantar
64	Right big toe	Plantar
65	Right second toe	Plantar
66	Right middle toe	Plantar
67	Right fourth toe	Plantar
68	Right little toe	Plantar
69	Left big toe	Plantar
70	Left second toe	Plantar
71	Left middle toe	Plantar
72	Left fourth toe	Plantar
73	Left little toe	Plantar
74	Front / ball of right foot	Plantar
75	Back / heel of right foot	Plantar
76	Front / ball of left foot	Plantar
77	Back / heel of left foot	Plantar
78	Right middle of foot	Plantar
79	Left middle of foot	Plantar
81	Right carpal delta area	Palm
82	Left carpal delta area	Palm
83	Right full palm, including writer's palm	Palm
84	Left full palm, including writer's palm	Palm

A.26. Table of XML Generalized Fingerprint Position Codes

Table A.26.: Table of XML Generalized Fingerprint Position Codes

Code	Description
0	Unknown finger (references every finger position from 1 - 10, 16, and 17)
1	Right thumb
2	Right index finger
3	Right middle finger
4	Right ring finger
5	Right little finger
6	Left thumb
7	Left index finger
8	Left middle finger
9	Left ring finger
10	Left little finger

A.27. Table of Minutiae Type Codes

Table A.27.: Table of Minutiae Type Codes

Code	Description
0	Minutia of type "other"
1	Ridge ending
2	Ridge bifurcation

A.28. Table of Minutiae Quality Codes

Table A.28.: Table of Minutiae Quality Codes

Code	Description
0	No quality value is available

A.29. Table of Off-Center Fingerprint Codes

Table A.29.: Table of Off-Center Fingerprint Codes

Code	Description
L	Left side of the finger or thumb
R	Right side of the finger or thumb
T	Tip (plain or rolled tip of the finger or thumb)

A.30. Table of File Type Codes

Table A.30.: Table of File Type Codes

Code	Description
ANALOG	Analog file
OTHER	Digital data stored in other formats that do not have computer file names and suffixes (such as digital tape)

A.31. Table of Fingerprint Impression Types

Table A.31.: Table of Fingerprint Impression Types

Code	Description
0	Plain contact Finger(s) / palm / plantar presented on platen or paper without rolling
1	Rolled contact Finger rolled on platen or paper
2	DEPRECATED Non-livescan, plain fingerprint
3	DEPRECATED Non-livescan, rolled fingerprint
4	Latent image Image or impression of friction skin deposited on a surface
5	DEPRECATED Latent fingerprint tracing
6	DEPRECATED Latent fingerprint photo
7	DEPRECATED Latent fingerprint lift
8	Live-scan swipe Finger / palm / plantar swiped on platen
10	DEPRECATED Livescan (type unknown or unspecified), palm
11	DEPRECATED Non-livescan, palm
12	DEPRECATED Latent palm impression
13	DEPRECATED Latent palm tracing
14	DEPRECATED Latent palm photo
15	DEPRECATED Latent palm lift
20	DEPRECATED Livescan optical contact, fingerprint plain
21	DEPRECATED Livescan optical contact, fingerprint rolled
22	DEPRECATED Livescan non-optical contact, fingerprint plain
23	DEPRECATED Livescan non-optical contact, fingerprint rolled
24	Plain contactless – stationary finger Finger(s) / palm / plantar presented stationary, in view of a stationary sensor and sensor captures plain contact equivalent
25	Rolled contactless – stationary subject Finger(s) / palm / plantar presented stationary, in view of a stationary sensor and sensor captures rolled equivalent
26	DEPRECATED Livescan non-optical contactless, fingerprint plain
27	DEPRECATED Livescan non-optical contactless, fingerprint rolled
28	Other
29	Unknown
30	DEPRECATED Livescan (type unknown or unspecified), plantar
31	DEPRECATED Non-livescan plantar
32	DEPRECATED Latent plantar impression

Appendix A. Code Tables

Table A.31.: Table of Fingerprint Impression Types

Code	Description
33	DEPRECATED Latent plantar tracing
34	DEPRECATED Latent plantar photo
35	DEPRECATED Latent plantar lift
36	DEPRECATED Latent impression, unknown friction ridge
37	DEPRECATED Latent source tracing, unknown friction ridge
38	DEPRECATED Latent photo, unknown friction ridge
39	DEPRECATED Latent lift, unknown friction ridge
41	Rolled contactless – moving subject Finger(s) / palm / plantar move through the capture volume of a sensor and sensor captures rolled equivalent
42	Plain contactless – moving subject Finger(s) / palm / plantar move through the capture volume of a sensor and sensor captures plain equivalent.

A.32. Table of Type of Substance Codes

Table A.32.: Table of Type of Substance Codes

Code	Description
1	Natural perspiration and/or body oils (eccrine and/or sebaceous)
2	Blood
3	Paint
4	Ink
5	Oil or grease
6	Dirt or soil
7	Other visible contaminants
8	Impression in pliable material
9	Contaminant removal via touch
10	Other/unknown matrix

A.33. Table of Latent Processing Method Codes

Table A.33.: Table of Latent Processing Method Codes

Code	Description
12I	1,2 Indanedione
ADX	Ardrox
ALS	Alternate light source
AMB	Amido black
AY7	Acid yellow 7
BAR	Basic red 26
BLE	Bleach (sodium hypochlorite)
BLP	Black powder
BPA	Black powder alternative (for tape)
BRY	Brilliant yellow (basic yellow 40)
CBB	Coomassie brilliant blue
CDS	Crowle's double stain
COG	Colloidal gold
DAB	Diaminobenzidine
DFO	1,8-diazafluoren-9-one
FLP	Fluorescent powder
GEN	Genipin
GRP	Gray powder
GTV	Gentian violet
HCA	Hydrochloric acid fuming
IOD	Iodine fuming
ISR	Iodine spray reagent
LAS	Laser
LCV	Leucocrystal violet
LIQ	Liquinox
LQD	Liquid-drox
MBD	7-p-methoxybenzylamino-4-nitrobenz-2-oxa-1, 3-diazole
MBP	Magnetic black powder
MGP	Magnetic grey powder
MPD	Modified physical developer
MRM	Maxillon flavine 10gff, Rhodamine 6g, and MBD
NIN	Ninhydrin
OTH	Other
PDV	Physical developer
R6G	Rhodamine 6G
RAM	Cyanoacrylate fluorescent dye (Rhodamine 6G, Ardrox, MBD)
SAO	Safranin O
SDB	Sudan black
SGF	Superglue fuming (cyanoacrylate)
SPR	Small particle reagent
SSP	Stickyside powder
SVN	Silver nitrate
TEC	Theonyl Europiom Chelate
TID	Titanium dioxide
VIS	Visual (patent image, not processed by other means)
WHP	White powder
ZIC	Zinc chloride

A.34. Table of Quality Issue Codes

Table A.34.: Table of Quality Issue Codes

Code	Description
ARTIFACT	Digital artifacts, such as occasionally caused by compression or livescan devices.
BACKGROUND	Interference with background makes following ridges difficult (e.g. check patterns)
COMPRESSED	Distorted area in which ridges are compressed together
DISTORT	Miscellaneous distortion (See also Compressed and Stretched)
NEGATIVE	Portion of the friction ridge image is tonally reversed (ridges appear white and valleys appear black). Note that Field 9.314 Tonal Reversal (TRV) is used if the entire image is tonally reversed.
OTHER	Other quality issues not characterized elsewhere; details should be noted in Comments
OVERDEV	Overdeveloped area: excessive processing medium such as ink, powder, etc.
OVERLAP	Area in which another friction ridge impression is superimposed over the impression of interest
SMEAR	Smearred or smudged area
STRETCHED	Distorted area in which ridges are stretched apart from each other
TAPE	Lifting tape artifacts (crease, bubble, etc.)

A.35. Table of Latent Substrate Codes

Table A.35.: Table of Latent Substrate Codes

Code	Description
1A	Paper
1B	Cardboard
1C	Unfinished/raw wood
1D	Other/unknown porous substrate
2A	Plastic
2B	Glass
2C	Metal, painted
2D	Metal, unpainted
2E	Glossy painted surface
2F	Tape, adhesive side
2G	Tape, nonadhesive side
2H	Aluminum foil
2I	Other/unknown nonporous substrate
3A	Rubber or latex
3B	Leather
3C	Photograph, emulsion side
3D	Photograph, paper side
3E	Glossy or semi-glossy paper or cardboard
3F	Satin or flat finish painted surface
3G	Other/unknown semi-porous substrate
4A	Other substrate (Specify)
4B	Unknown substrate

A.36. Table of Feature Detection Method Codes

Table A.36.: Table of Feature Detection Method Codes

Code	Description
AUTO	The fingerprint features were detected and encoded by an automated process without any possibility of human editing. The algorithm shall be noted in the appropriate information item.
EDIT	The fingerprint features were detected and encoded by an automated process, but manually edited. The algorithm and examiner's name shall be noted in the appropriate information items.
MAN	The fingerprint features were manually detected and encoded. The examiner's name shall be noted in the appropriate information item.
REV	The fingerprint features were detected and encoded by an automated process, and manually reviewed without the need for manual editing. The algorithm and examiner's name shall be noted in the appropriate information items.

A.37. Table of Minutiae Type Codes

Table A.37.: Table of Minutiae Type Codes

Code	Description
B	Ridge bifurcation
E	Ridge ending
X	Ridge ending or bifurcation, no distinction provided

A.38. Table of Minutiae Ridge Count Algorithm Codes

Table A.38.: Table of Minutiae Ridge Count Algorithm Codes

Code	Description
EFTS7	Identical to OCTANT algorithm, except that ridge count values are one more than the number of intervening ridges. This was the format used by the FBI in its EFTS Version 7.1
OCTANT	The minutiae used for ridge counts are the nearest neighbors in eight octants, with the center of the 0th octant defined by the current minutia's theta, and the 1st through 7th octants proceeding counter clockwise. Ridge count values are set to number of intervening ridges. (Default)
QUADRANT	The minutiae used for ridge counts are the nearest neighbors in four quadrants, defined by the image's vertical and horizontal axes. The quadrants, with the 1st quadrant at the upper right and the 2nd through 4th quadrants proceeding counterclockwise. Ridge count values are set to the number of intervening ridges

A.39. Table of Minutiae Residual Codes

Table A.39.: Table of Minutiae Residual Codes

Code	Description
0	Neighboring minutia lies in the clockwise half of the octant
1	Neighboring minutia lies in the counterclockwise half of the octant

A.40. Table of Offense Codes

Table A.40.: Table of Offense Codes

Code	Description
ICM	CRIMES AGAINST CHILDREN
IFA	AIDING A CRIMINAL
IFE	ESCAPED
IFL	AT LARGE
IHG	GENOCIDE
IHH	CRIMES AGAINST HUMANITY
IHW	WAR CRIME
III	ILLEGAL IMMIGRATION
IIO	ILLEGAL IMMIGRATION ORGANIZER
IIP	TRAFFIC IN HUMAN BEINGS ORGANIZER
IIT	TRAFFIC IN HUMAN BEINGS
IKA	CRIME AGAINST FAMILY/ABDUCTION
IKK	KIDNAPPING/ILLEGAL IMPRISONMENT
IKP	MARITIME PIRACY/ROBBERY ON THE HIGH SEAS
ILA	ASSAULT/MALTREATMENT
ILB	TORTURE/BARBAROUS ACT
ILG	DESECRATION OF BURIAL PLACE
ILM	INJURY CAUSING DEATH/MANSLAUGHTER/MURDER
ILO	ORGANS (HORMONES to be considered)
ILT	THREATS
IOO	CRIMINAL ORGANIZATION/ASSOCIATION/GROUP
IRO	ROAD TRAFFIC RELATED OFFENCE
ISE	SEXUAL EXPLOITATION/PROSTITUTION
ISP	PRODUCTION/DISTRIBUTION OF PORNOGRAPHY
ISR	RAPE
ISS	SEXUAL OFFENCES
ITA	TERRORISM LOGISTIC SUPPORT
ITB	BIOLOGICAL TERRORISM
ITC	CHEMICAL TERRORISM
ITF	TERRORISM FINANCING
ITM	TERRORIST GROUP MEMBER
ITR	RADIOLOGICAL/NUCLEAR TERRORISM
ITT	TERRORISM RELATED CRIME
ITZ	TERRORISM ACTS
NLC	NOT LISTED CRIME
PAA	WORK OF ART
PCF	FORGERY
PCM	COUNTERFEIT CURRENCY
PCO	PHARMACEUTICAL CRIME
PCP	INTELLECTUAL PROPERTY CRIME
PCT	FORGERY OF TRAVEL DOCUMENTS
PDA	DOPING AGENTS AND ANABOLICS
PDC	CANNABIS
PDD	DRUG(S)
PDH	HEROIN/MORPHINE/OPIUM
PDO	COCAINE
PDP	PSYCHOTROPICS
PEB	BACTERIOLOGICAL/BIOLOGICAL/NUCLEAR
PEC	CHEMICAL SUBSTANCES
PEE	ENVIRONMENTAL CRIME
PEW	WILDLIFE CRIME
PFB	BANKING/FINANCIAL FRAUD

Appendix A. Code Tables

Table A.40.: Table of Offense Codes

Code	Description
PFC	BRIBERY/CORRUPTION
PFF	FRAUD
PFG	FRAUD AGAINST GOVERNMENT
PFM	COMMERCIAL FRAUD
PFV	CURRENCY CONTROL VIOLATION
PHH	HIJACKING OF MEANS OF TRANSPORT (PLANE, SHIP, BUS, CAR...)
PIH	HIGH TECH CRIME
PMM	MONEY LAUNDERING
PTA	AGGRAVATED THEFT
PTB	BURGLARY
PTE	EXTORTION
PTR	RECEIVING STOLEN PROPERTY
PTS	THEFT
PTW	ARMED ROBBERY
PTY	ROBBERY
PVV	VANDALISM/DAMAGE/LOOTING/HOOLIGANISM
PWA	ARSON
PWC	AMMUNITION/COMPONENTS/FIREARMS/WEAPONS/EXPLOSIVES
PWE	USE OF AN EXPLOSIVE DEVICE (BOMBING)

A.41. Table of Palmprint Acquisition Profiles

Table A.41.: Table of Palmprint Acquisition Profiles

Code	Description
70	PAP 70 (min scanning resolution = 500 ppi+/-1%; min image dimensions = 5"x5"; max compression ratio = 15:1; compression algorithm = WSQ v3.1 or above)
80	PAP 80 (min scanning resolution = 500 ppi+/-1%; min image dimensions = 5"x8"; max compression ratio = 15:1; compression algorithm = WSQ v3.1 or above)
170	PAP 170 (min scanning resolution = 1000 ppi+/-1%; min image dimensions = 5"x5"; max compression ratio = 10:1; compression algorithm = JPEG 2000)
180	PAP 180 (min scanning resolution = 1000 ppi+/-1%; min image dimensions = 5"x8"; max compression ratio = 10:1; compression algorithm = JPEG 2000)

A.42. Table of Pattern Classification Codes

Table A.42.: Table of Pattern Classification Codes

Code	Description
AU	Arch
DR	Dissociated Ridges/Dysplasia (Unable to classify)
LS	Left Slant Loop
RS	Right Slant Loop
SR	Complete Scar (Unable to classify)
UC	Unable to Classify
UP	Temporarily unable to print (e.g., bandaged)
WU	Whorl
XX	Amputation (Unable to print)

A.43. Table of Pattern Classification Subcodes

Table A.43.: Table of Pattern Classification Subcodes

Code	Description
AW	Accidental Whorl
CP	Central Pocket Loop Whorl
DL	Double Loop Whorl
PA	Plain Arch
PW	Plain Whorl
TA	Tented Arch

A.44. Table of Whorl-Delta Relationship Codes

Table A.44.: Table of Whorl-Delta Relationship Codes

Code	Description
I	Inner (ridge flow from left delta is above right delta)
M	Meeting (ridge flow from left delta meets right delta)
O	Outer (ridge flow from left delta is below right delta)

A.45. Table of Growth or Shrinkage Type Codes

Table A.45.: Table of Growth or Shrinkage Type Codes

Code	Description
B	Both: impression may be larger or smaller than exemplars or other prints from the same subject
G	Growth: impression is believed to be larger than exemplars or other prints from the same subject
S	Shrinkage: impression is believed to be smaller than exemplars or other prints from the same subject

A.46. Table of Possible Lateral Reversal Codes

Table A.46.: Table of Possible Lateral Reversal Codes

Code	Description
L	Image is known to be laterally reversed.
U	Image may be laterally reversed

A.47. Table of Subject Pose Codes

Table A.47.: Table of Subject Pose Codes

Code	Description
A	Angled Pose
D	Determined 3D Pose
F	Full Face Frontal
L	Left Profile (-90 degree)
R	Right Profile (90 degree)

A.48. Table of Quality Value Codes

Table A.48.: Table of Quality Value Codes

Code	Description
254	No attempt to calculate a quality score was made
255	Failed attempt to calculate a quality score

A.49. Table of Method of Ridge Counting Codes

Table A.49.: Table of Method of Ridge Counting Codes

Code	Description
A	Auto: The ridge count was automatically performed without human review
M	Manual Ridge Count: The ridge count was determined or validated manually by a human examiner
T	Manual Tracing: The ridge count was automatically determined, based on a skeletonized image created by a human examiner

A.50. Table of Ridge Count Extraction Method Codes

Table A.50.: Table of Ridge Count Extraction Method Codes

Code	Description
0	No assumption shall be made about the method used to extract ridge counts, nor their order in the record
1	For each center minutiae, ridge count data was extracted to the nearest neighboring minutiae in four quadrants
2	For each center minutiae, ridge count data was extracted to the nearest neighboring minutiae in eight octants

A.51. Table of Result Determination Mode Codes

Table A.51.: Table of Result Determination Mode Codes

Code	Description
AC	AUTO CONFIRMED - Request / Result from an automated “lights out” search (i.e. no operator verification or intervention. A single candidate only response anticipate where match results, meeting the agreed positive match confidence parameters. For no match response , all candidates would be below any agreed negative match parameters and none returned.
UC	UNCONFIRMED – Request / Result for a set of possible matches with one or more candidates (or an agreed number of candidates) or no match result; Further verification activity anticipated on any response to confirm matches.
QS	QUICK SEARCH – Requests a set of possible matches with one or more candidates. Appropriate match confidence rating (separate field) where results potentially to be used without further verification activity anticipated.
CO	CONFIRMED – Request/ Results verified/confirmed on the system receiving the request. Only positive match candidates or no match response returned.
SL	SILENT – No Results anticipated via this channel.

A.52. Table of Record Type Codes

Table A.52.: Table of Record Type Codes

Code	Description
1	Transaction information
2	User-defined descriptive text
4	High-resolution grayscale fingerprint image
7	User-defined image
8	Signature image
9	Minutiae data
01	Transaction information
02	User-defined descriptive text
04	High-resolution grayscale fingerprint image
07	User-defined image
08	Signature image
09	Minutiae data
10	Face, other body part, or scar, mark, tattoo (SMT) image
13	Variable-resolution latent friction ridge image
14	Variable-resolution fingerprint image
15	Variable-resolution palmprint image
16	User-defined variable-resolution testing image
17	Iris image
18	DNA data
19	Variable-resolution plantar image
20	Source representation
21	Associated context
98	Information assurance
99	CBEFF biometric data record

A.53. Table of Type of Feature Codes

Table A.53.: Table of Type of Feature Codes

Code	Description
D	Discontinuity (point where a ridge stops briefly)
I	Indentation (abrupt decreases in ridge width)
P	Protrusion (abrupt increases in ridge width)

A.54. Table of Ridge Flow Data Format Codes

Table A.54.: Table of Ridge Flow Data Format Codes

Code	Description
B64	Base-64 format ridge flow map
UNC	Uncompressed (concatenated hexadecimal) ridge flow map

A.55. Table of Ridge Quality Data Format Codes

Table A.55.: Table of Ridge Quality Data Format Codes

Code	Description
RLE	Run-length encoded ridge quality map
UNC	Uncompressed ridge quality map

A.56. Table of Ridge Quality Map Codes

Table A.56.: Table of Ridge Quality Map Codes

Code	Description
0	Background (no ridge information)
1	Debatable ridge flow (continuity of ridge flow is uncertain)
2	Definitive ridge flow, debatable minutiae (continuity of ridge flow is certain; minutiae are debatable)
3	Definitive minutiae, debatable ridge edges (minutiae, and ridge flow are obvious and unambiguous; ridge edges are debatable)
4	Definitive ridge edges, debatable pores (Ridge edges, minutiae, and ridge flow are obvious and unambiguous; pores are either debatable or not present)
5	Definitive pores (Pores and ridge edges are obvious and unambiguous)

A.57. Table of Subject Acquisition Profile Codes

Table A.57.: Table of Subject Acquisition Profile Codes

Code	Description
0	Unknown acquisition profile
1	Surveillance facial image
10	Driver's license image (AAMVA)
11	ANSI Full Frontal facial image (ANSI 385)
12	ANSI Token facial image (ANSI 385)
13	ISO Full Frontal facial image (ISO/IEC 19794-5)
14	ISO Token facial image (ISO/IEC 19794-5)
15	PIV facial image (NIST SP 800-76)
20	Legacy Mugshot
30	Best Practice Application - Level 30
32	Mobile ID Best Practice - Level 32
40	Best Practice Application - Level 40
42	Mobile ID Best Practice - Level 42
50	Best Practice Application - Level 50
51	Best Practice Application - Level 51
52	Mobile ID Best Practice - Level 52

A.58. Table of Sex Codes

Table A.58.: Table of Sex Codes

Code	Description
M	Male
F	Female
U	Unknown

A.59. Table of Scale Units Codes

Table A.59.: Table of Scale Units Codes

Code	Description	Notes
0	No scale is provided	
1	Pixels per inch (ppi)	
2	Pixels per centimeter (ppcm)	

A.60. Table of Types of Transactions

Table A.60.: Table of Types of Transactions

Code	Description
ATP	Add to Print Collection. This transaction is used for sending a complete set of prints (fingerprints and/or palm prints) as a new record or to replace an existing record. The request is stored and optionally searched according to the target system.
CPS	Criminal Print-to-Print Search. This transaction is a request for a search only of a record relating to a person fingerprinted for a criminal offence against a prints database.
NPS	Non-criminal Print-to-Print Search. This transaction is a request for a search against a database that falls outside the scope of a CPS transaction.
MPS	Latent-to-Print Search. This transaction is used when a latent is to be searched against a Prints database. If the latent is not already in the remote system, it must be included as an image in the file.
SRE	Search Results. This transaction contains data detail of the results of the search request. The way fields are interpreted will depend on the original search request and to whom the search request was sent. If the SRE transaction is coming from an AFIS, the system will specify a list of potential matches in the Respondents List (RLS). Additional information regarding the search, can be attached using the available record types.
ERR	Error Message. This transaction is generated if the remote system has difficulty processing the transaction, e.g. if a particular search is not allowed on the system or the transaction is not conformant to the relevant Implementation. The error message will contain the error code and the textual description of the cause of the issue.

A.61. Table of Tonal Reversal Codes

Table A.61.: Table of Tonal Reversal Codes

Code	Description
N	Negative - ridges are light and valleys are dark throughout the image.
P	Partial - ridges are light and valleys are dark only in portions of the image